

# AMINO ACID STRUCTURE

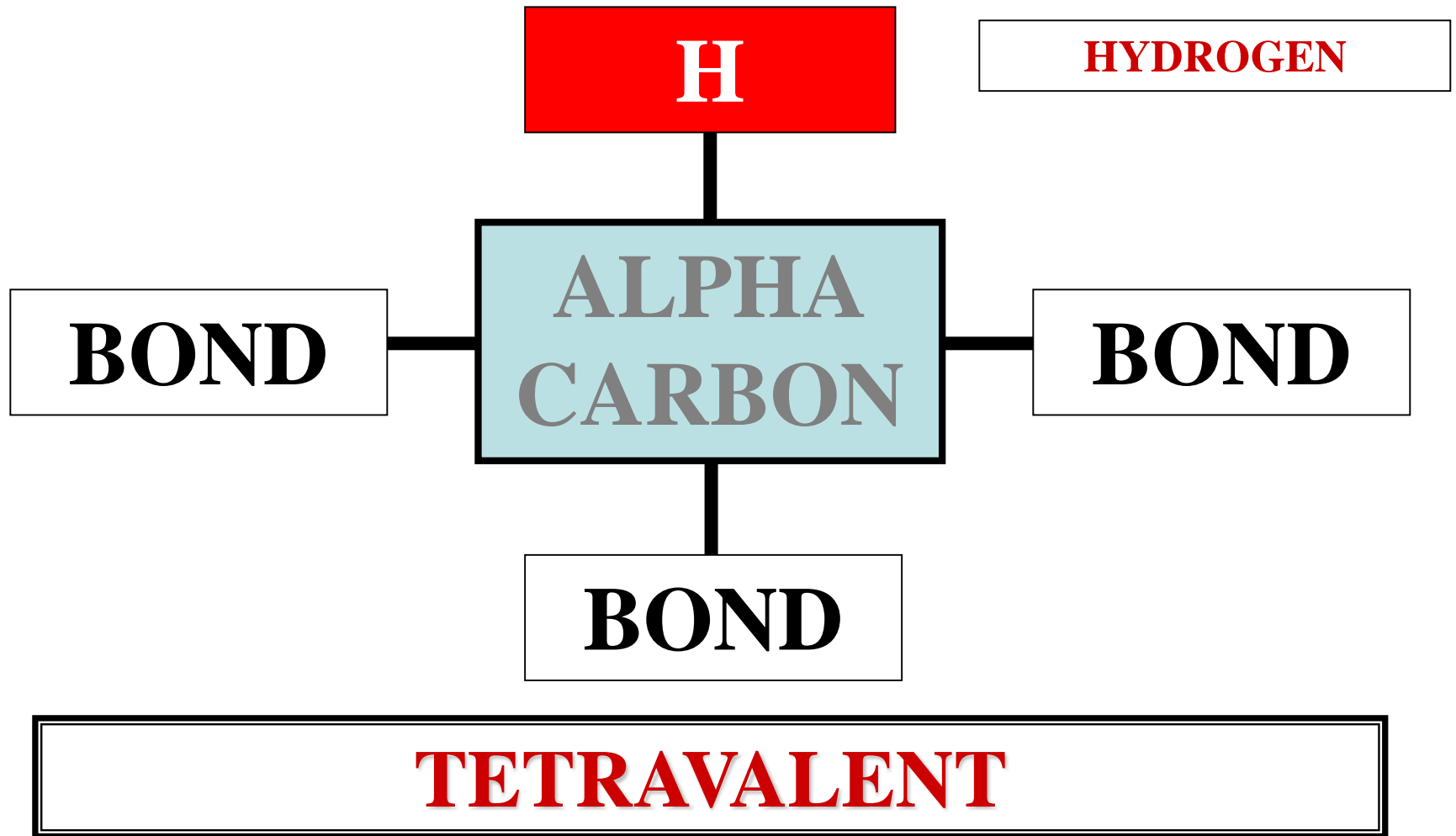

# AMINO ACID STRUCTURE

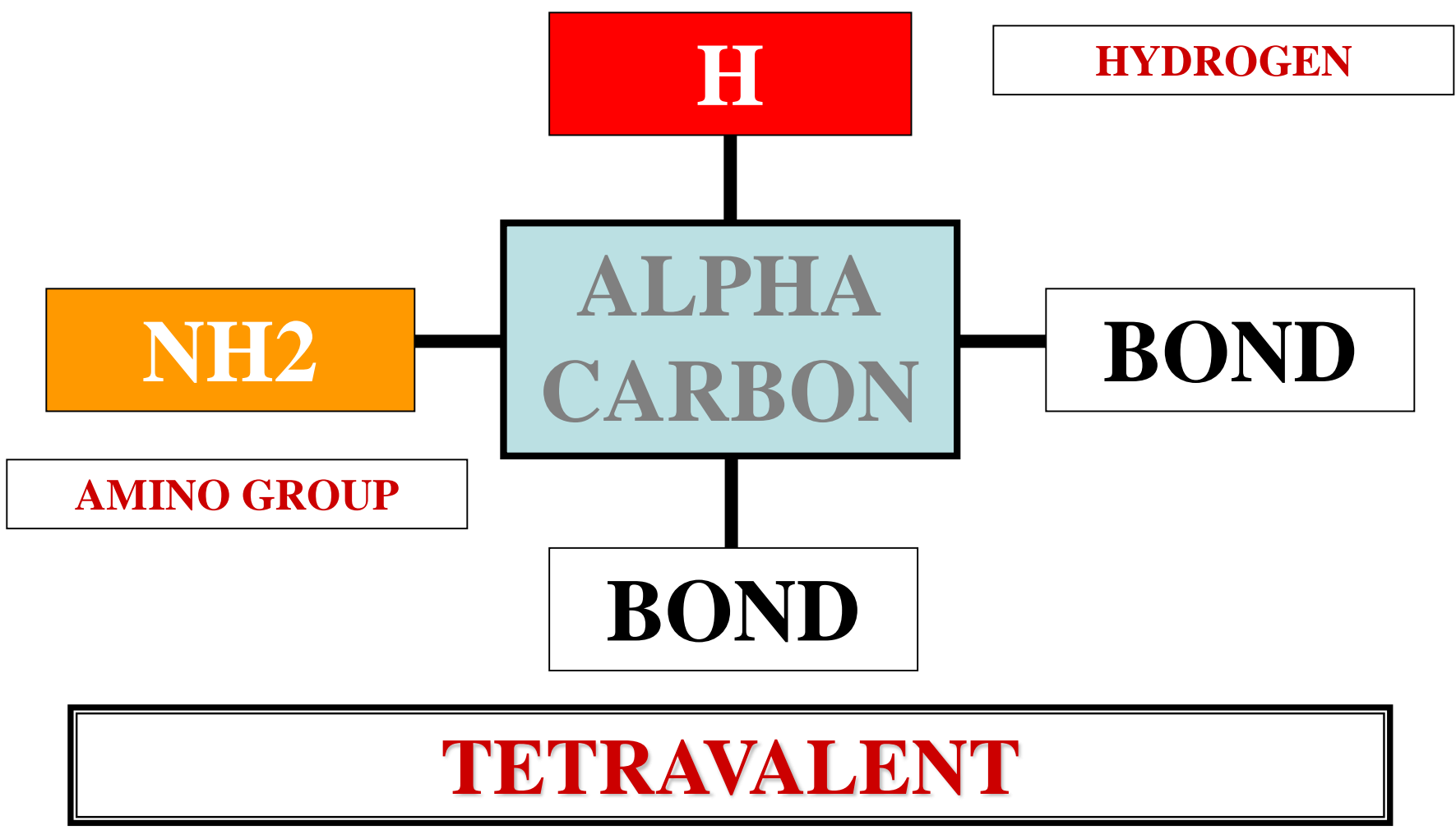

# AMINO ACID STRUCTURE

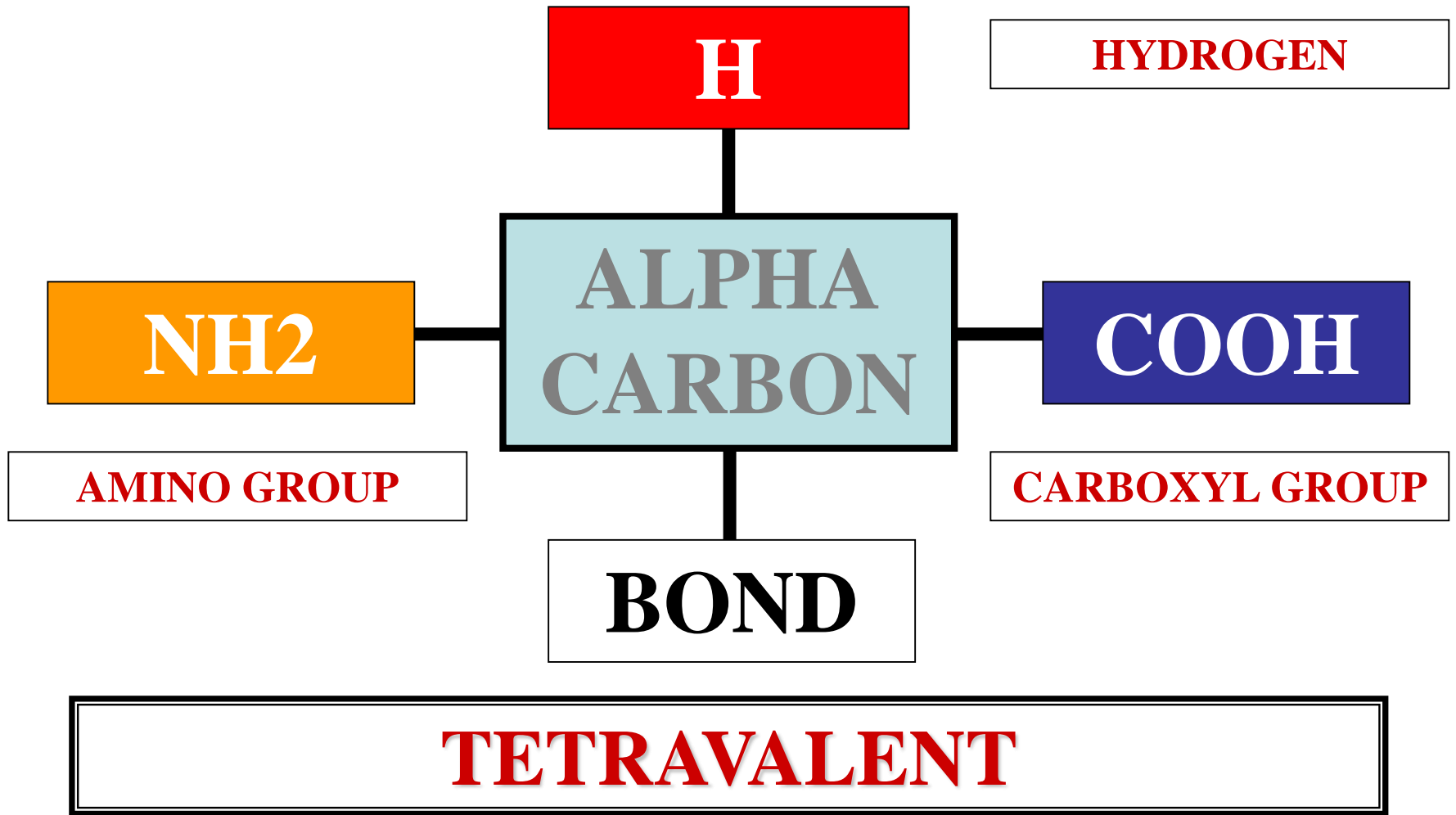

# AMINO ACID STRUCTURE

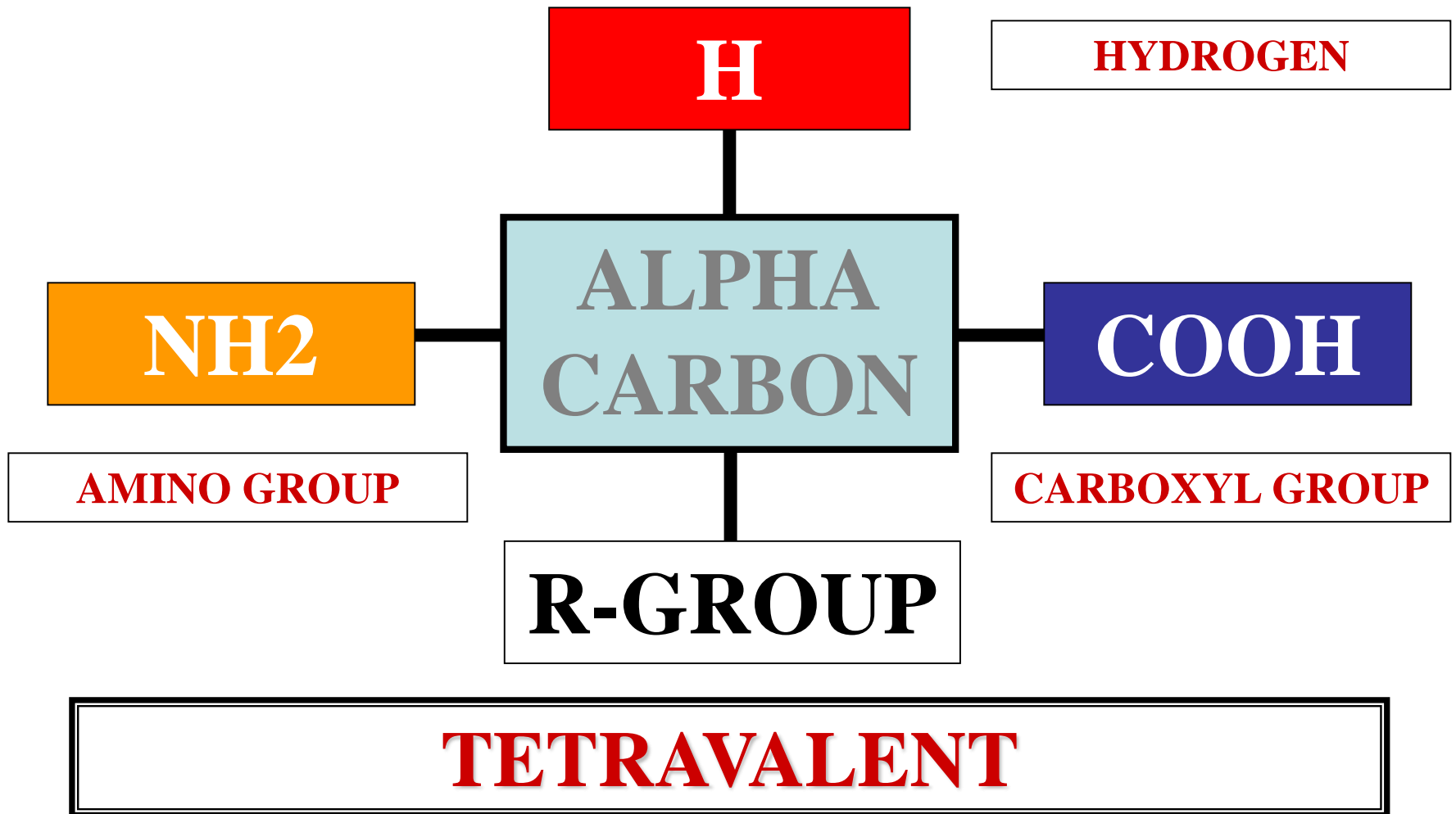

# AMINO ACID STRUCTURE

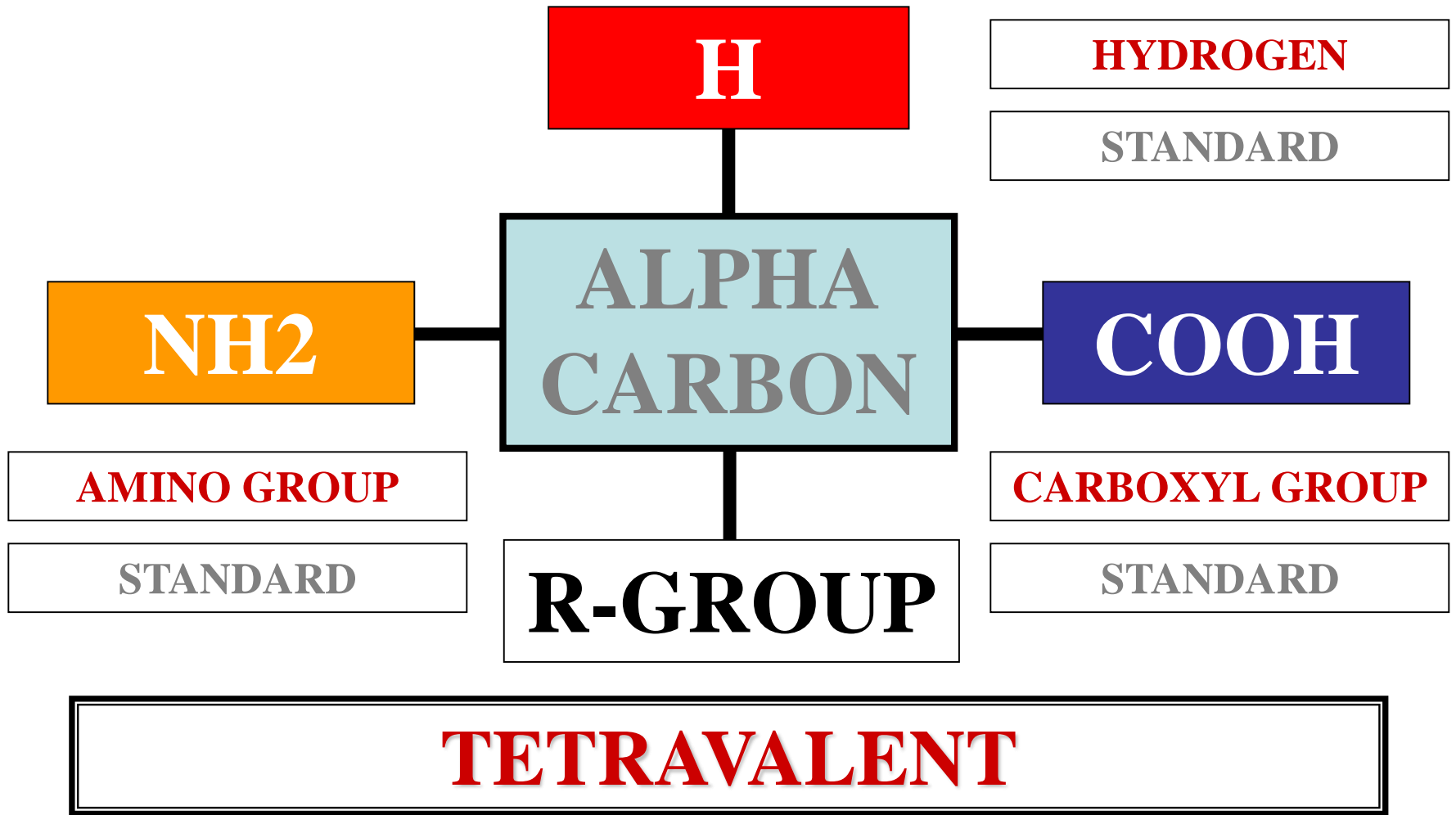

# AMINO ACID STRUCTURE

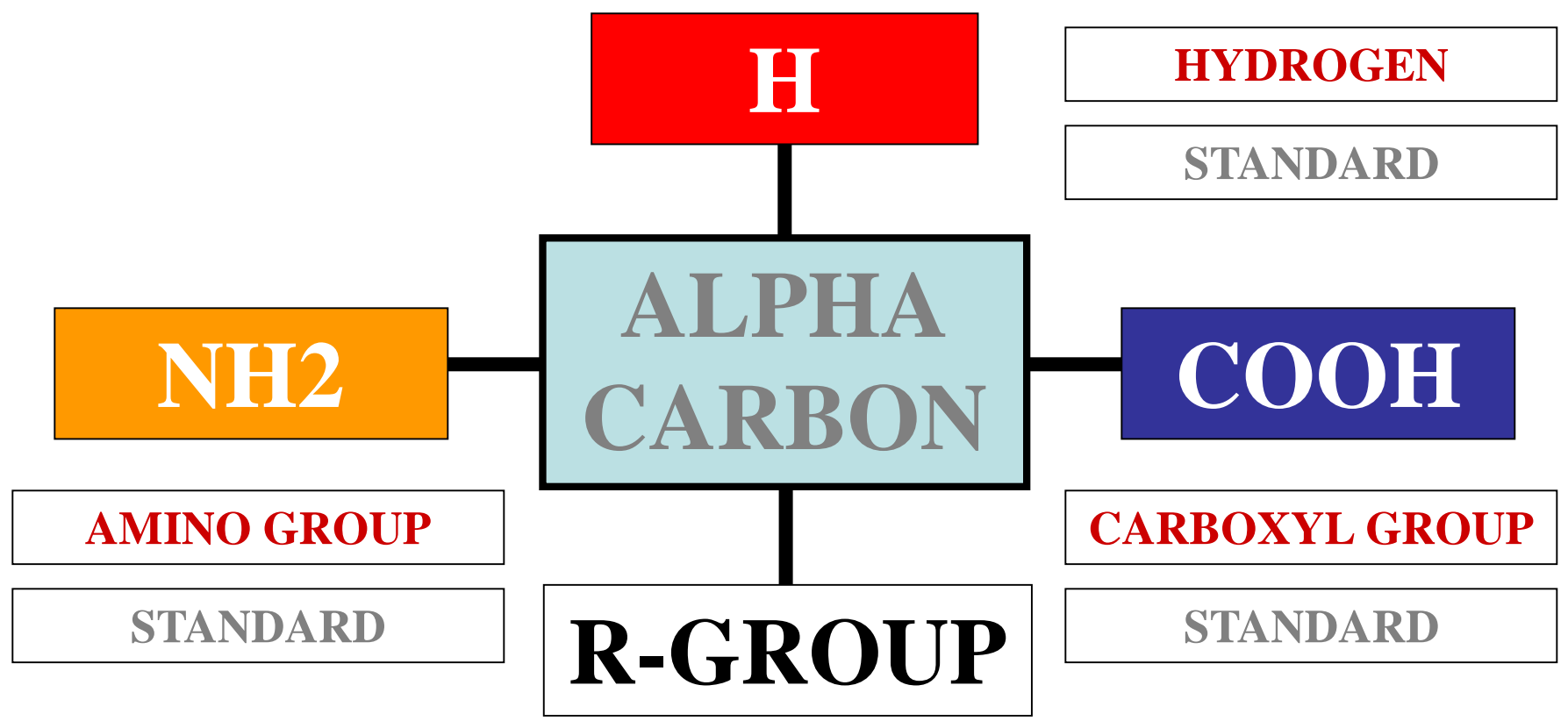

**R-GROUP VARIES W/ A.A.**

# AMINO ACID STRUCTURE

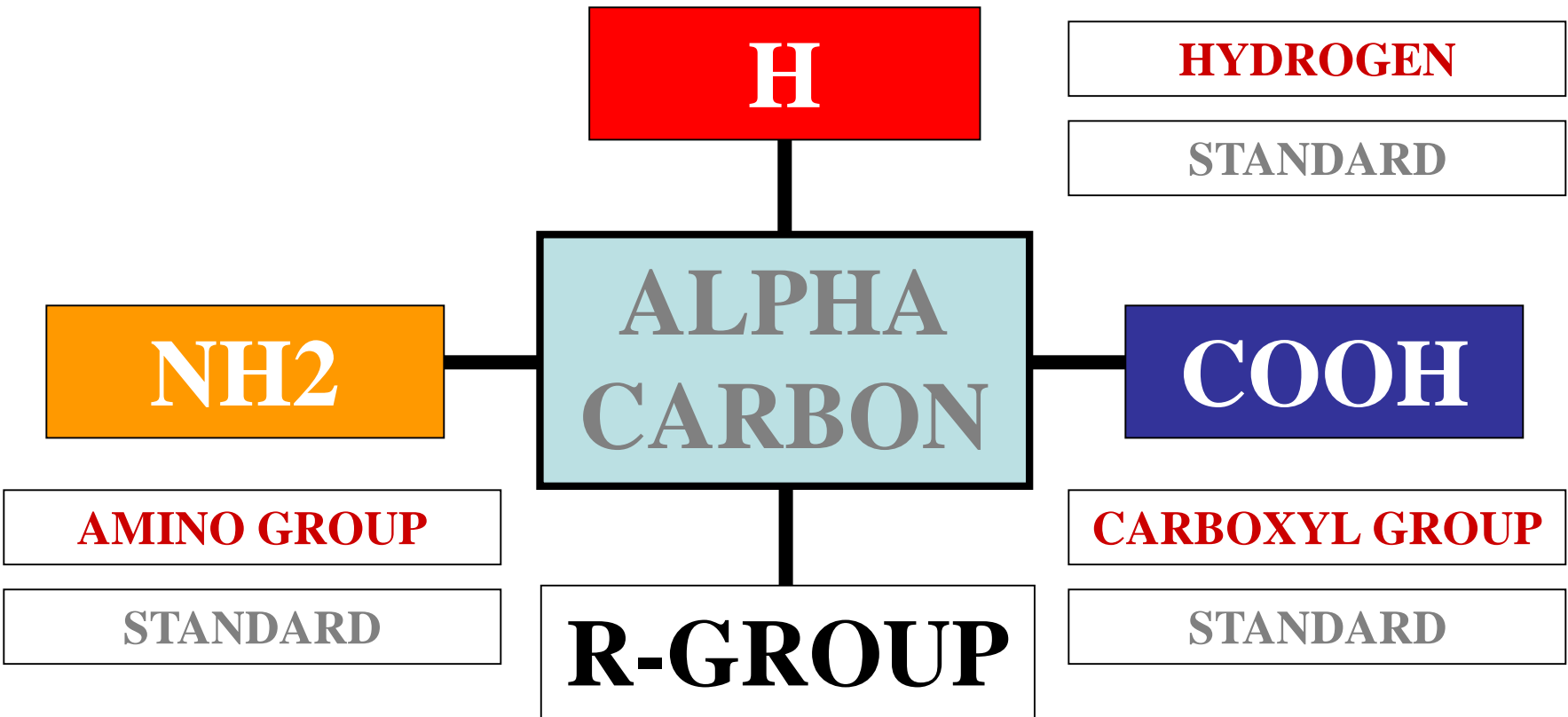

**20 DIFFERENT R-GROUPS**

# AMINO ACID STRUCTURE

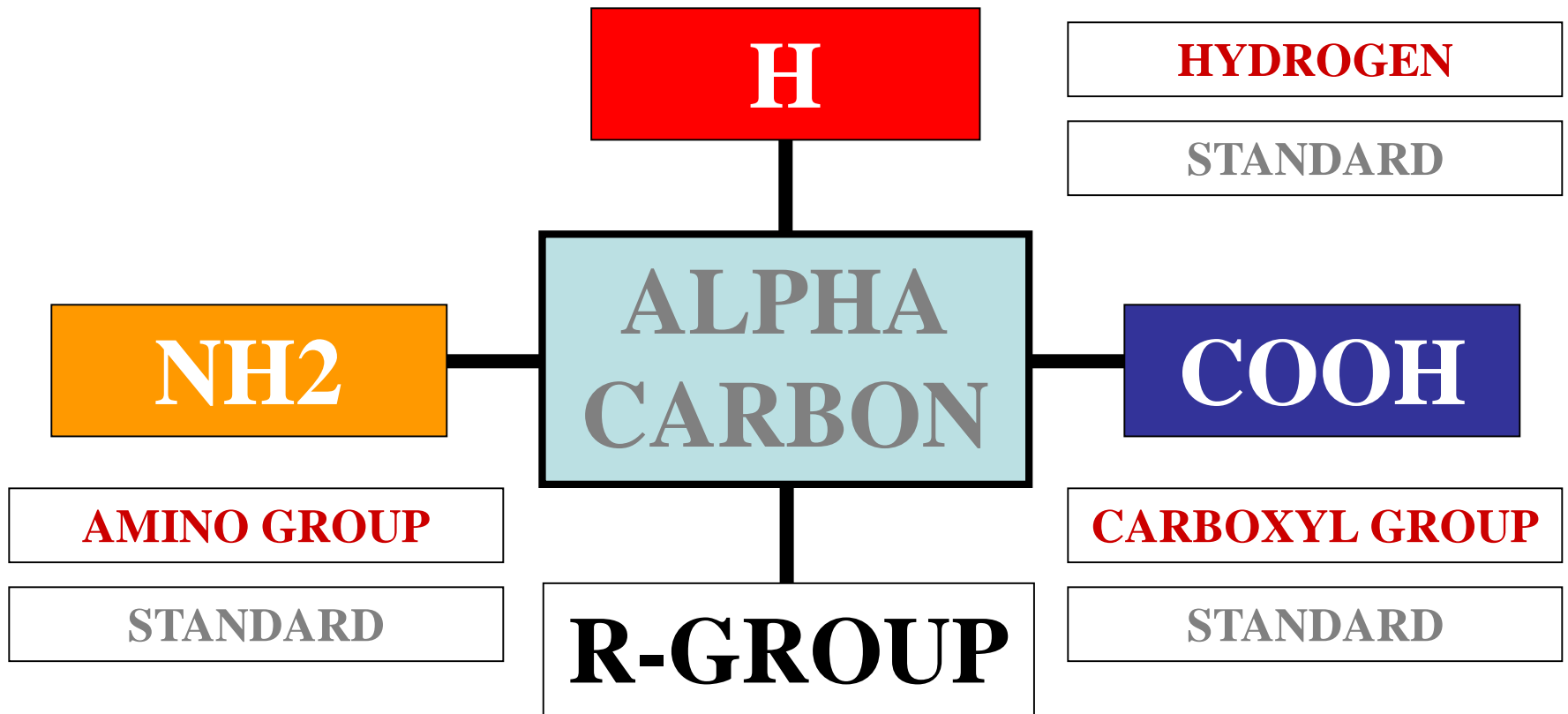

**20 DIFFERENT AMINO ACIDS**



# 20 PROTEIN AMINO ACIDS

## Nonpolar side chains; hydrophobic

Side chain (R group)

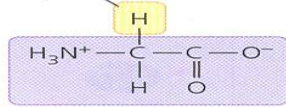

Glycine (Gly or G)

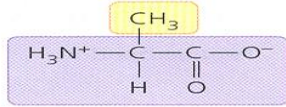

Alanine (Ala or A)

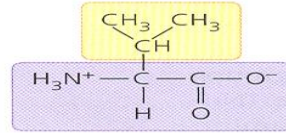

Valine (Val or V)

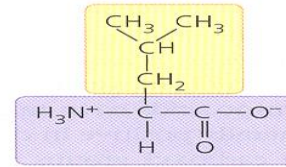

Leucine (Leu or L)

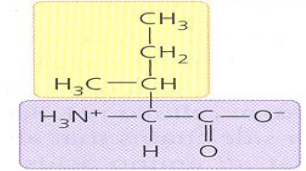

Isoleucine (Ile or I)

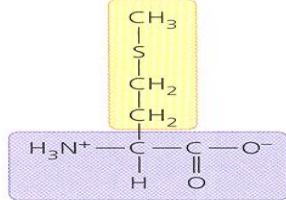

Methionine (Met or M)

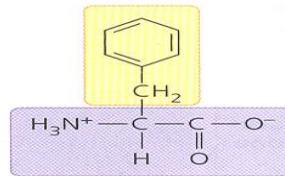

Phenylalanine (Phe or F)

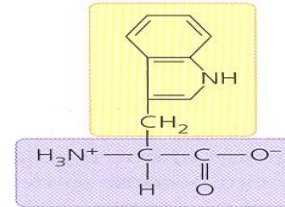

Tryptophan (Trp or W)

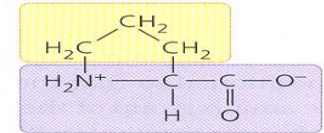

Proline (Pro or P)

## Polar side chains; hydrophilic

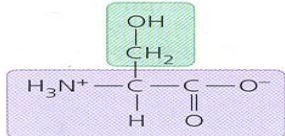

Serine (Ser or S)

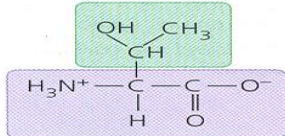

Threonine (Thr or T)

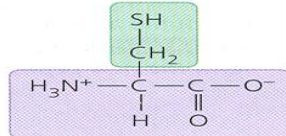

Cysteine (Cys or C)

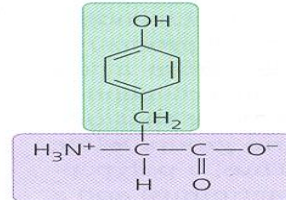

Tyrosine (Tyr or Y)

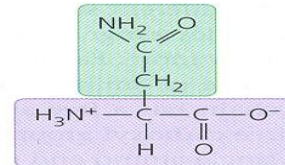

Asparagine (Asn or N)

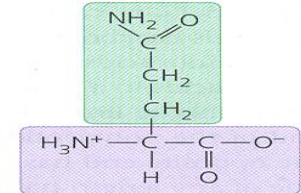

Glutamine (Gln or Q)

## Electrically charged side chains; hydrophilic

### Acidic (negatively charged)

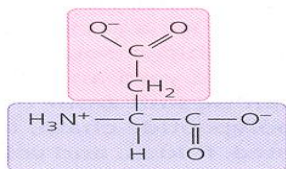

Aspartic acid (Asp or D)

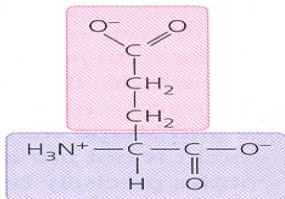

Glutamic acid (Glu or E)

### Basic (positively charged)

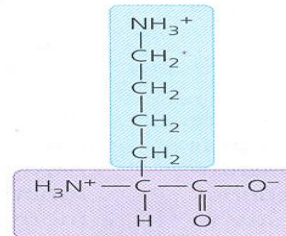

Lysine (Lys or K)

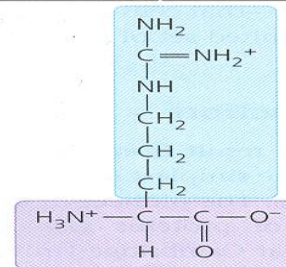

Arginine (Arg or R)

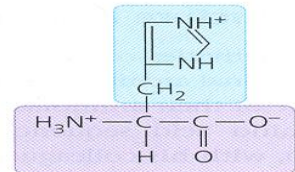

Histidine (His or H)



# **AMINO ACID EXAMPLES**

# AMINO ACID STRUCTURE

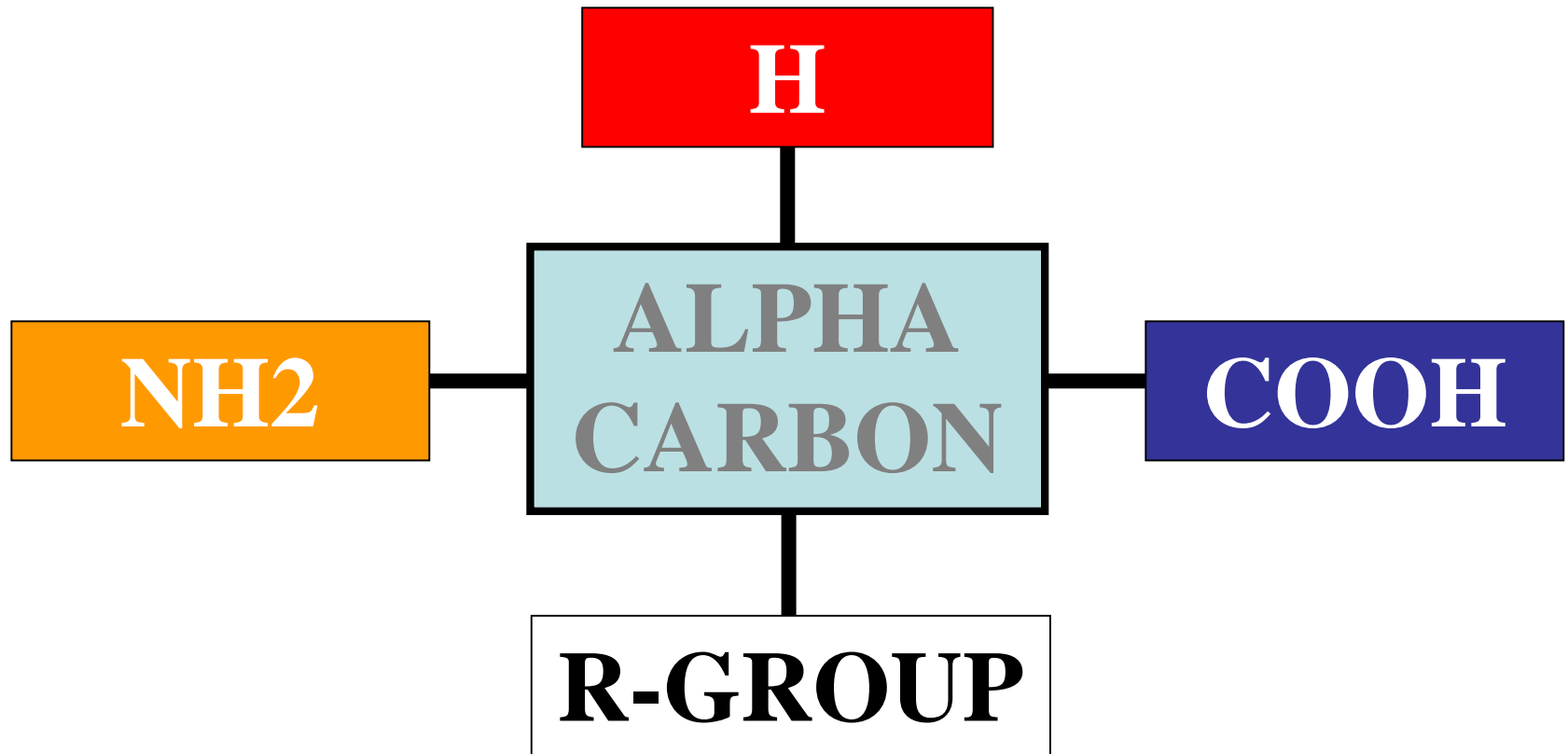

## STANDARD STRUCTURE

# AMINO ACID STRUCTURE

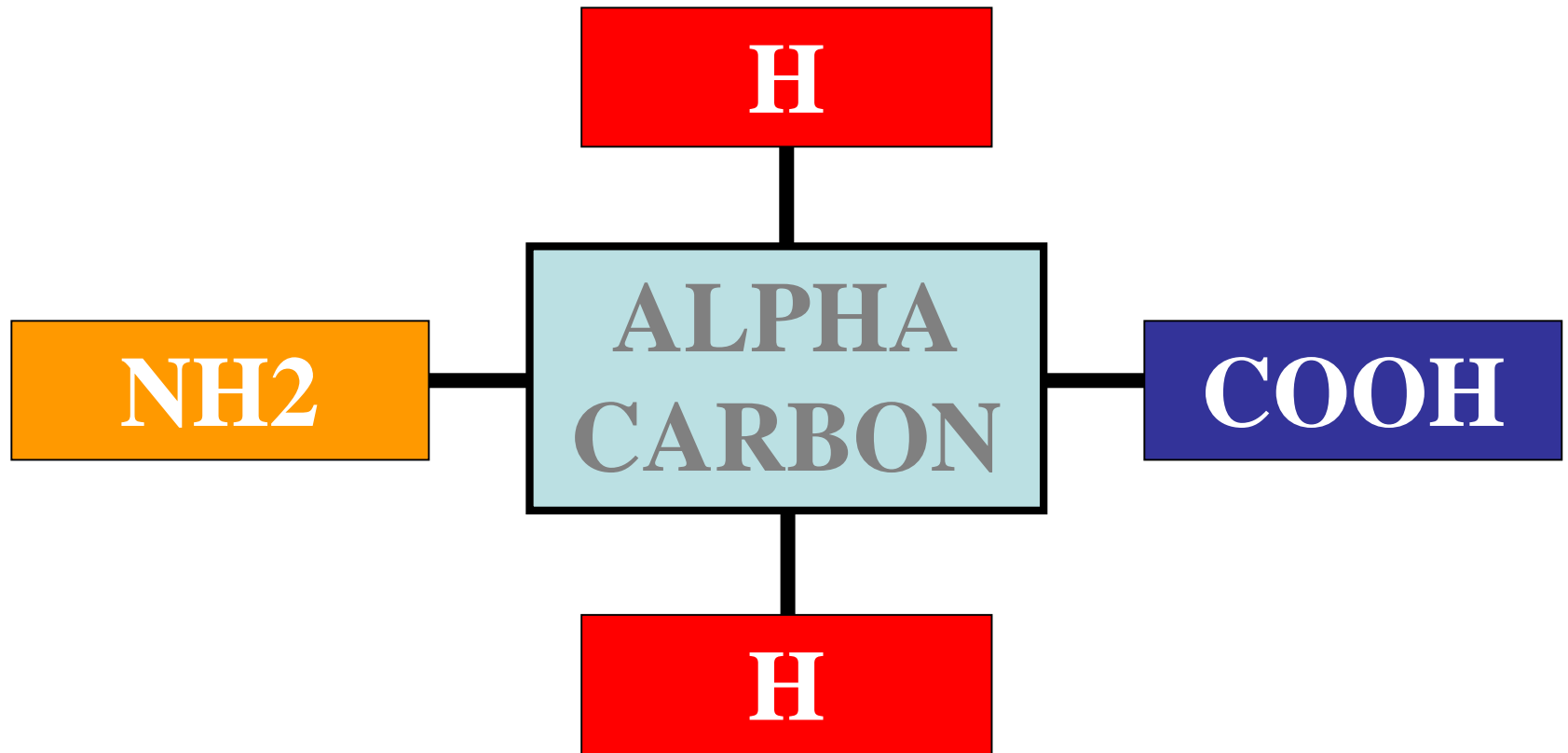

**HYDROGEN**

# AMINO ACID STRUCTURE

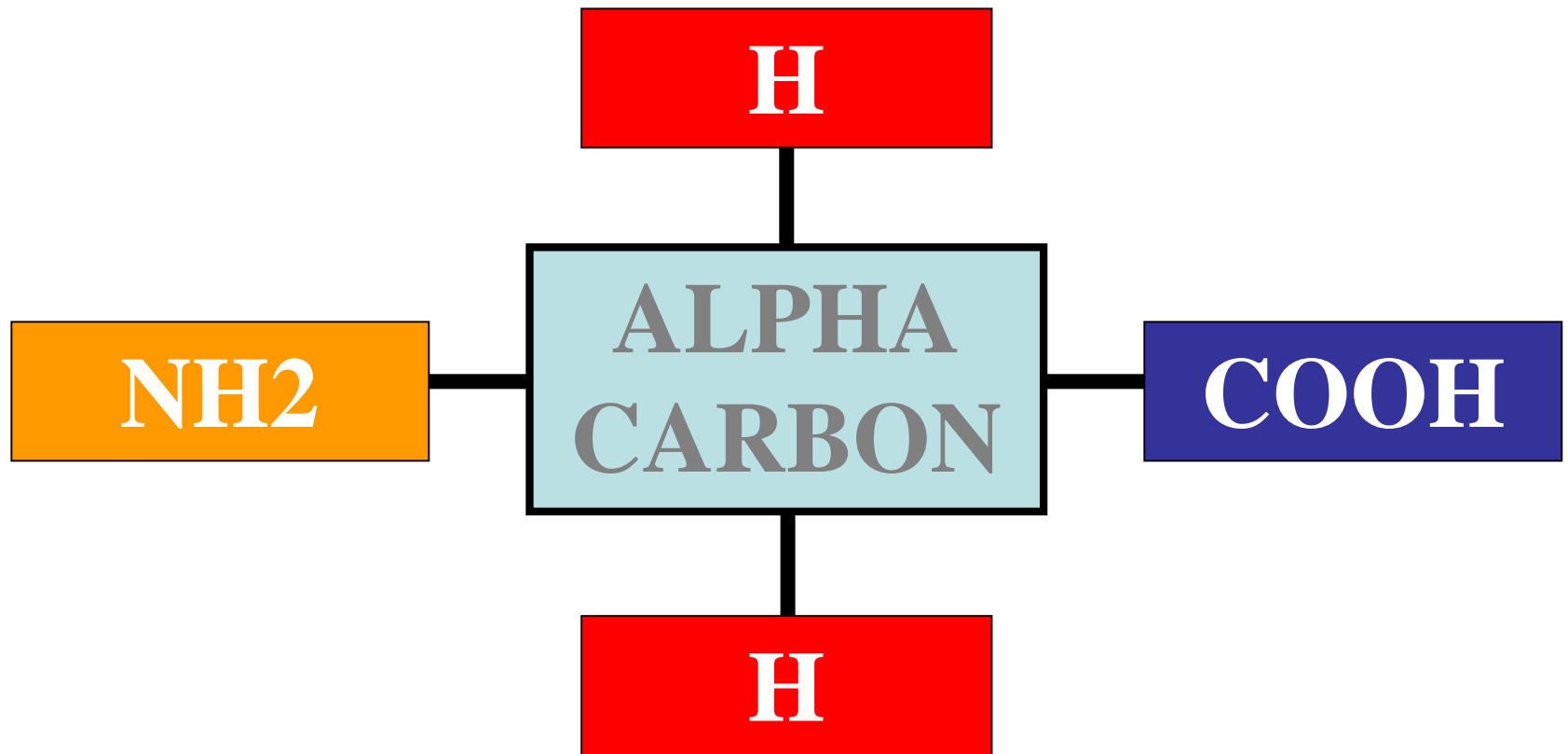

**AMINO ACID: GLYCINE**

# AMINO ACID STRUCTURE

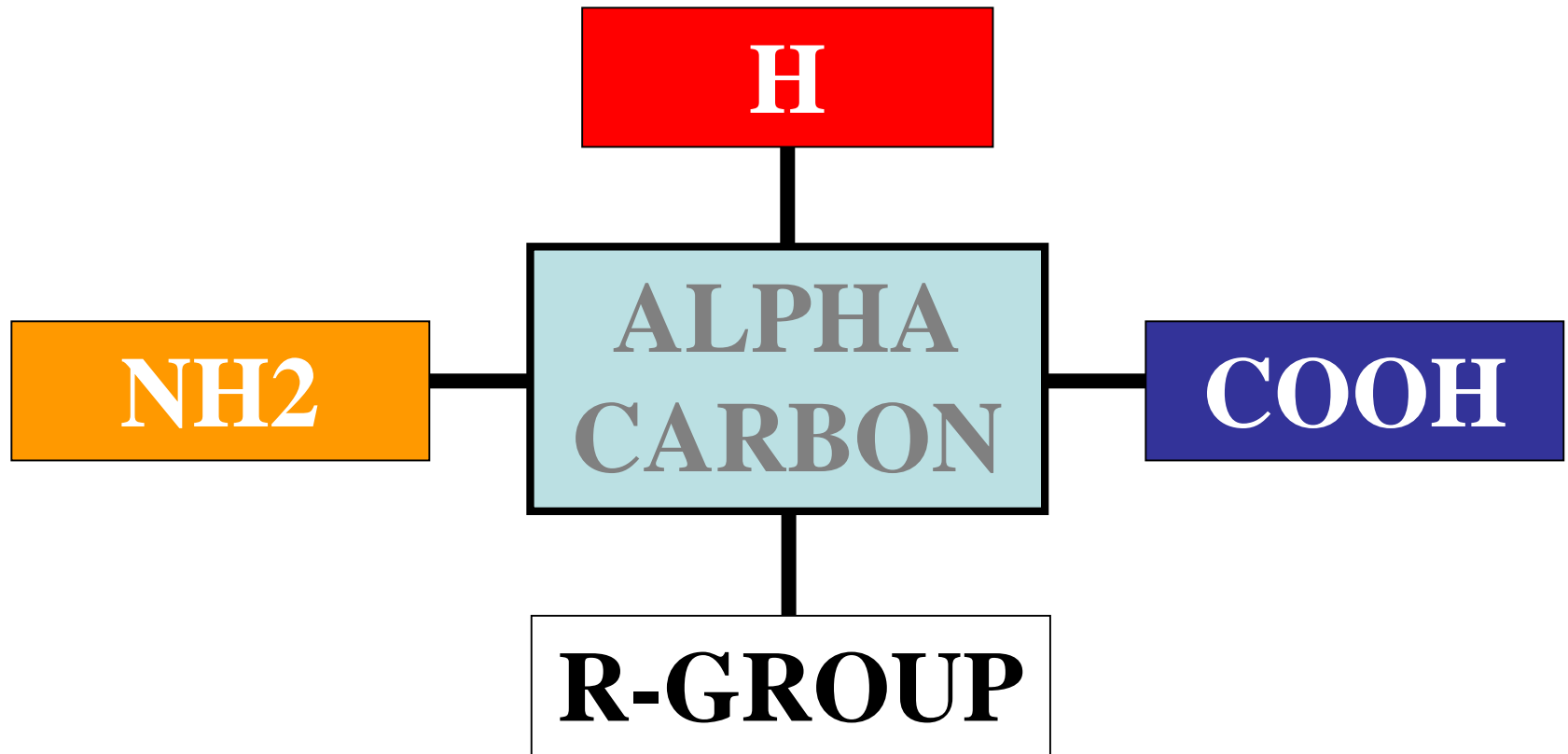

## STANDARD STRUCTURE

# AMINO ACID STRUCTURE

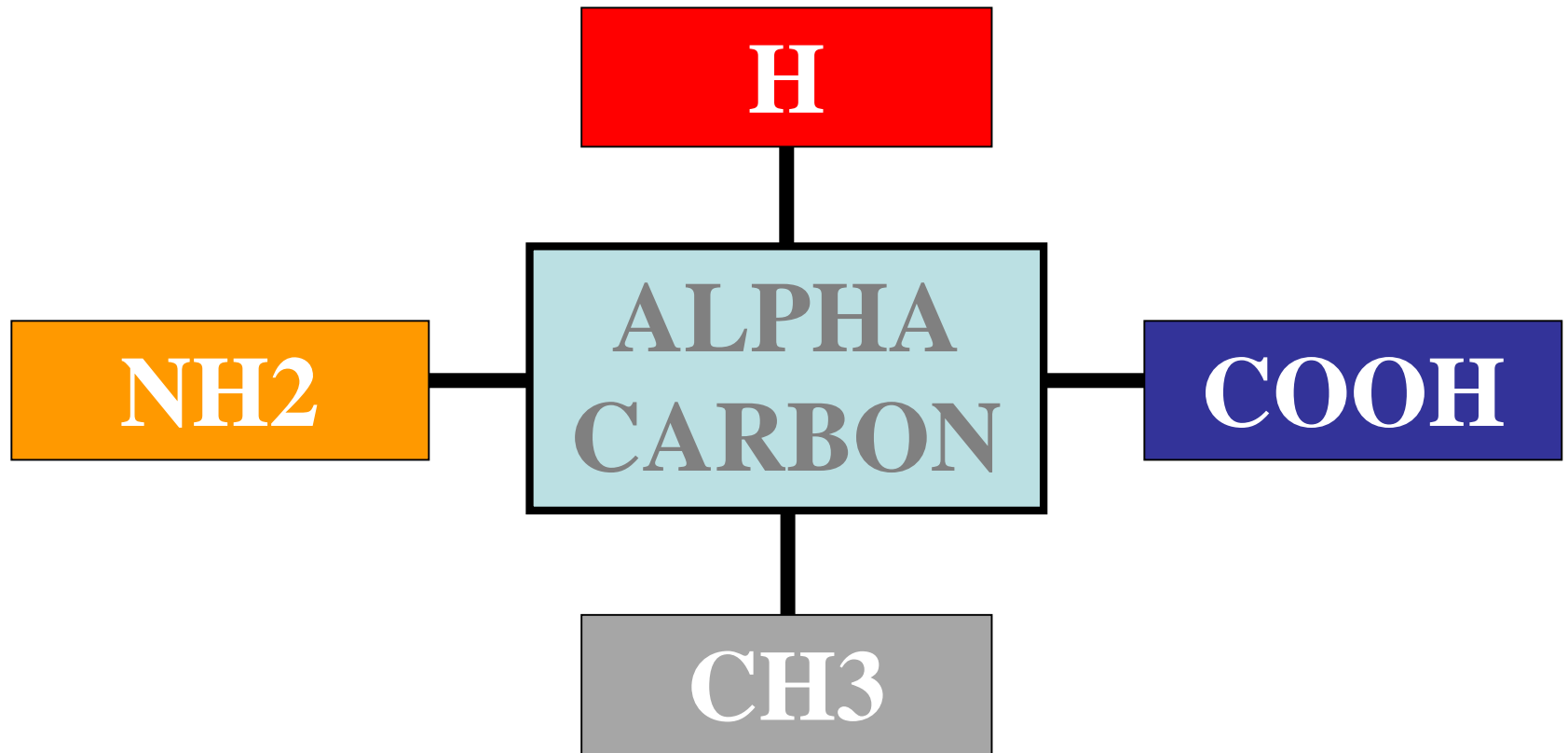

**METHYL GROUP**

# AMINO ACID STRUCTURE

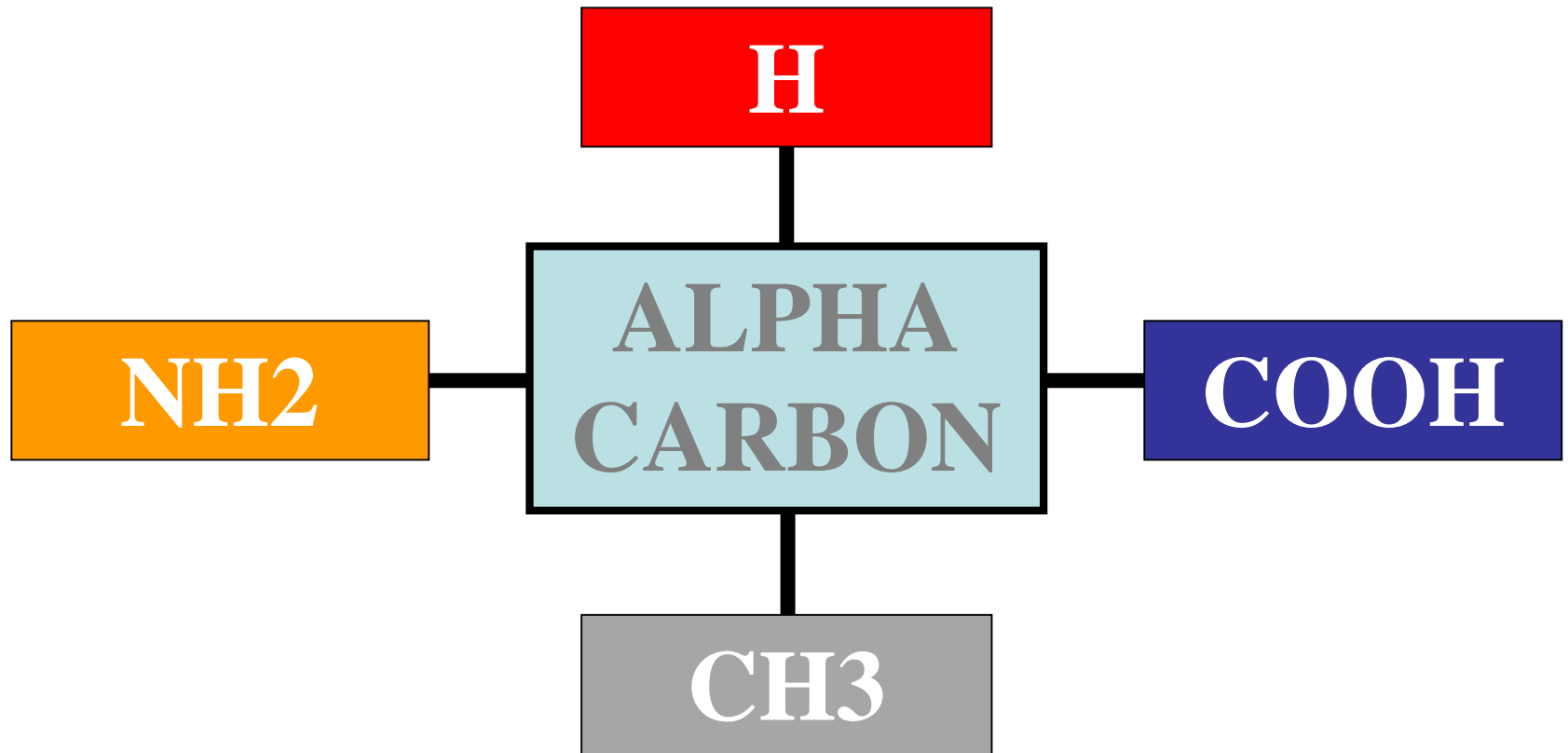

**AMINO ACID: ALANINE**



# AMINO ACID STRUCTURE SUMMARY

# AMINO ACID STRUCTURE

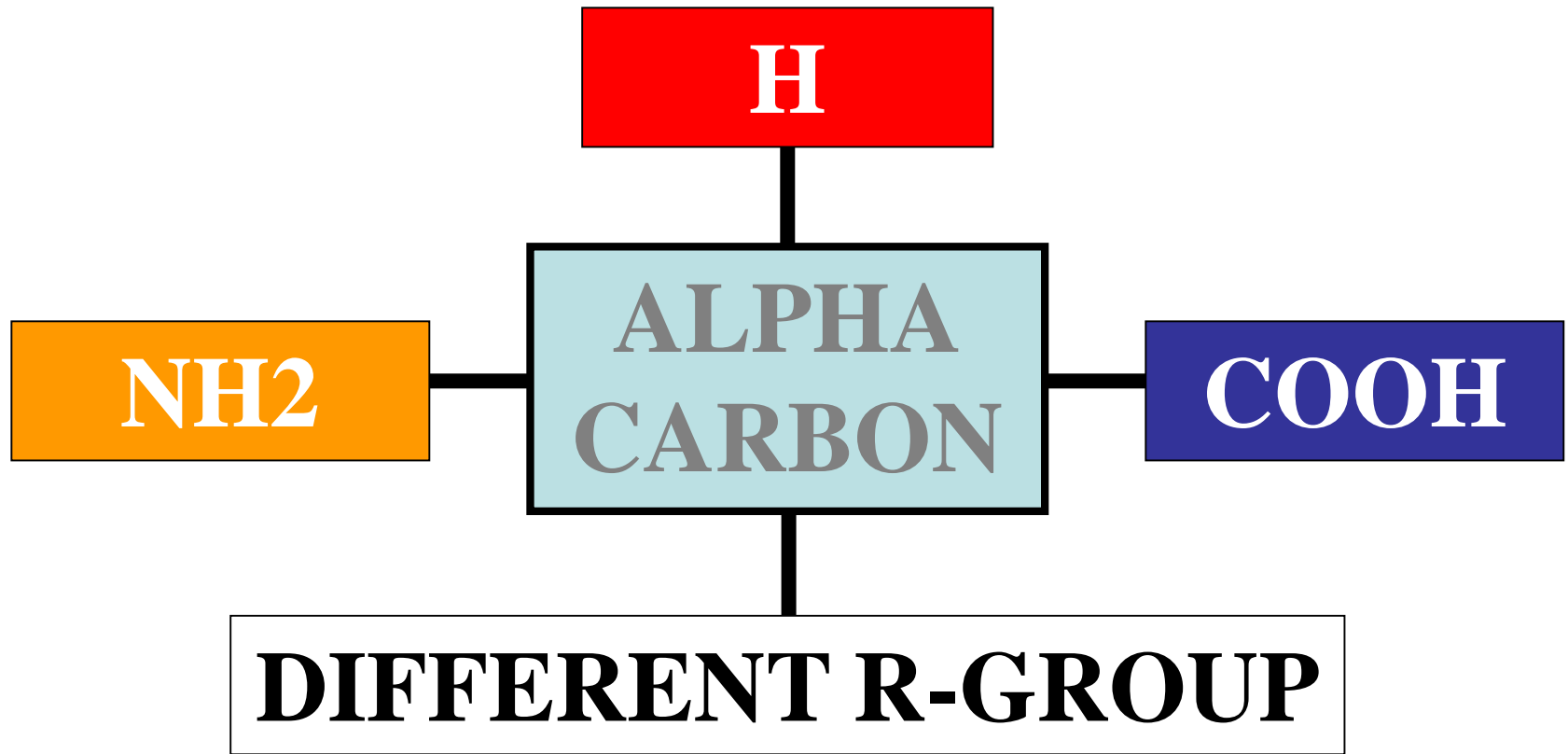

**STANDARD STRUCTURE**

# AMINO ACID STRUCTURE

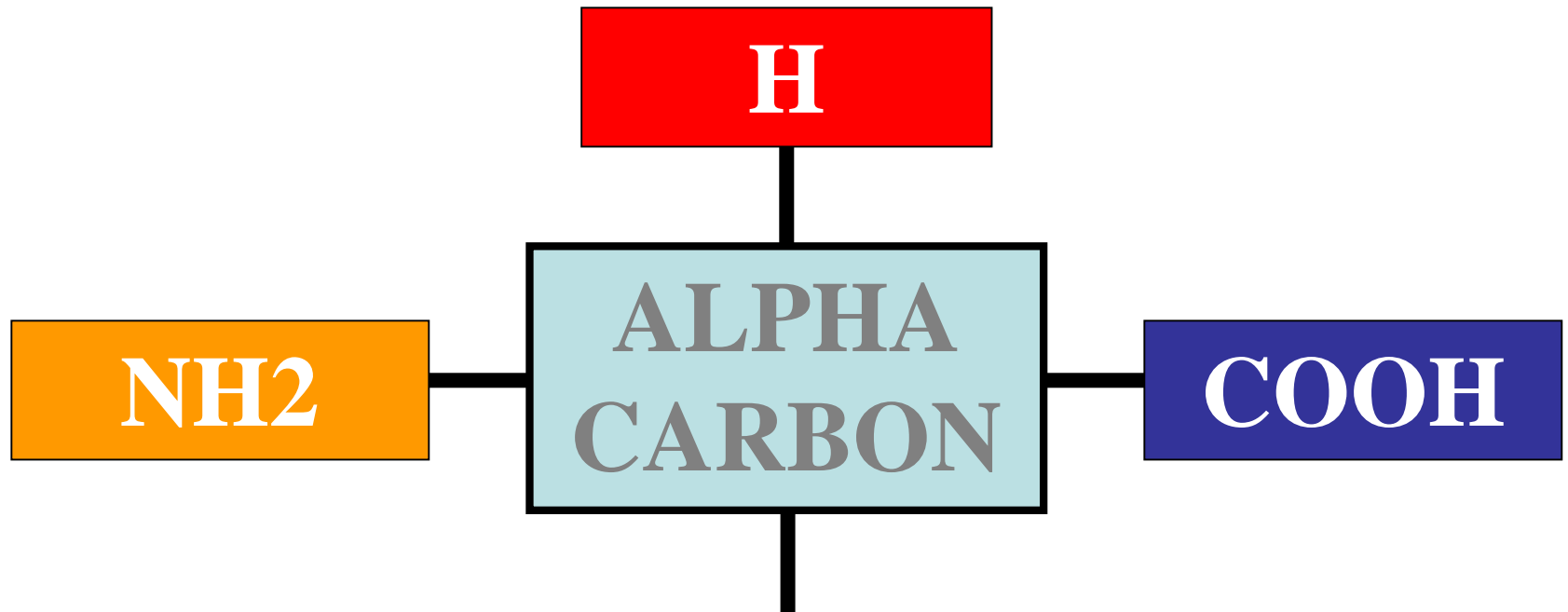

**DIFFERENT AMINO ACID**

**STANDARD STRUCTURE**

# PROTEIN AMINO ACID POLYMER

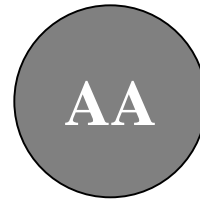
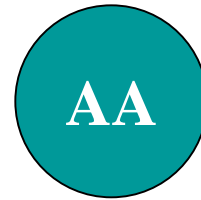
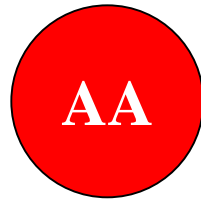
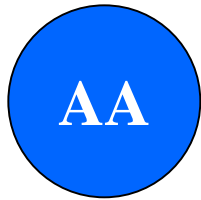
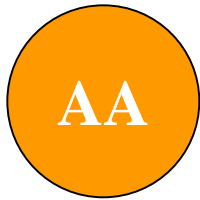
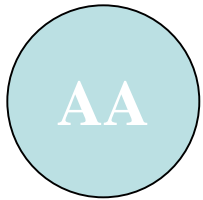

**AMINO ACID**

# PROTEIN

## AMINO ACID POLYMER

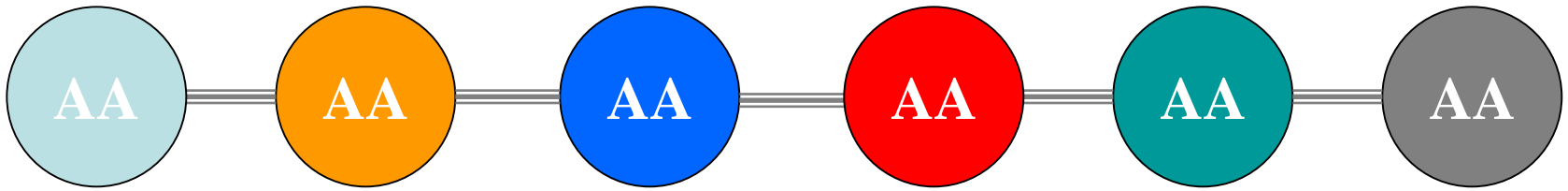

AMINO ACID  $\equiv$  = BOND

# PROTEIN AMINO ACID POLYMER

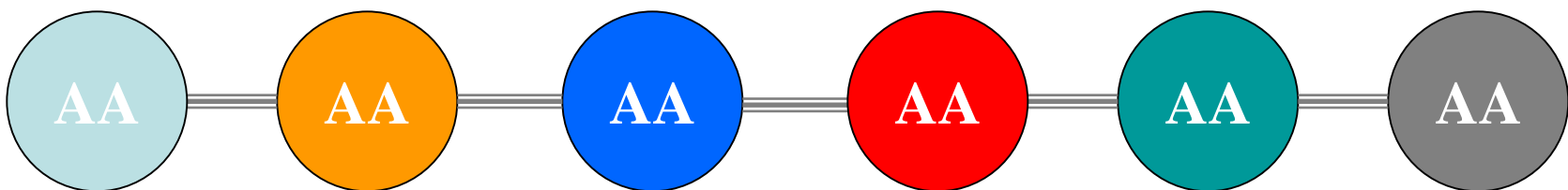

AMINO ACID == = PEPTIDE BOND

**PEPTIDE BOND  
LINKS  
AMINO ACIDS**

# PEPTIDE BOND

# PEPTIDE BOND





**PEPTIDE BOND**

**COVALENT BOND**

**PEPTIDE BOND**



**PEPTIDE BOND**

**COVALENT BOND**

----

**FORMED VIA**

**COOH & NH<sub>2</sub>**

**INTERACTION**

**PEPTIDE BOND**

# PEPTIDE BOND

C



= AMINO ACID

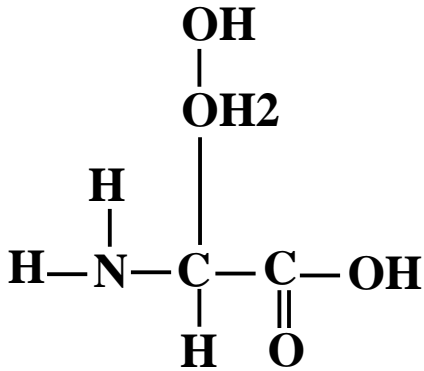

AMINO ACID

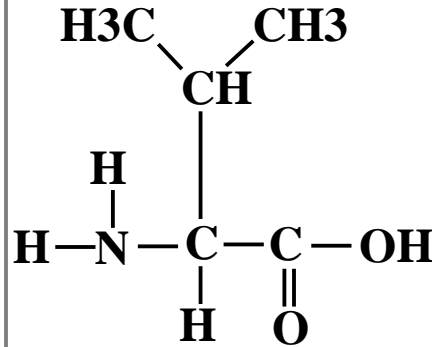

AMINO ACID

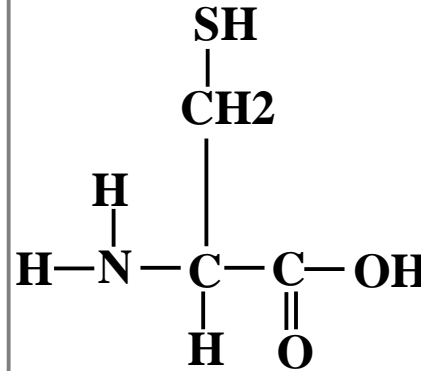

AMINO ACID

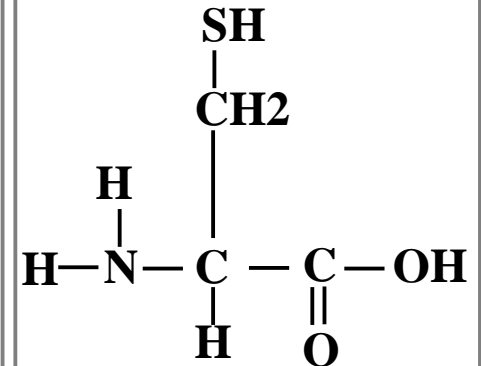

AMINO ACID

# PEPTIDE BOND

A



= AMINO ACID

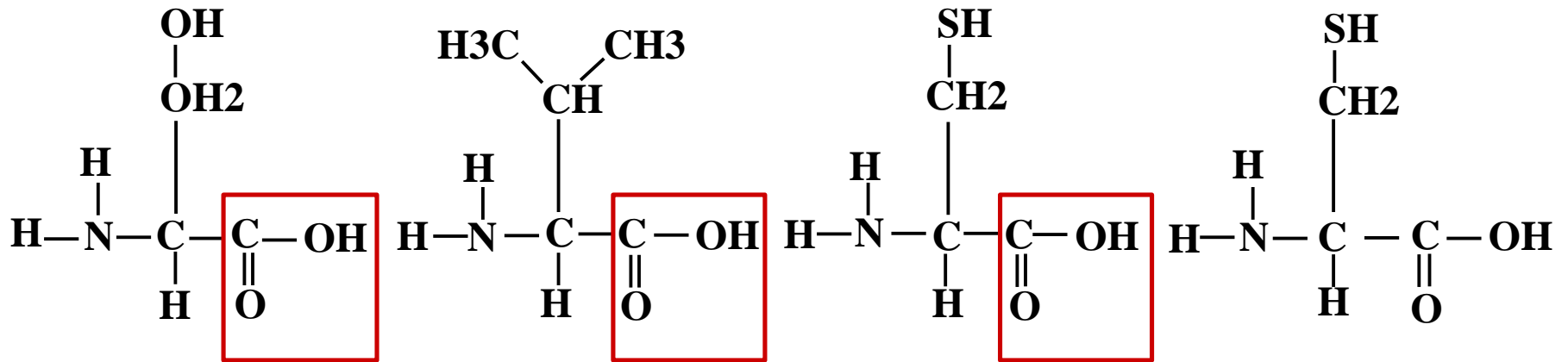

**CARBOXYL GROUP**

# PEPTIDE BOND

**I**  = AMINO ACID

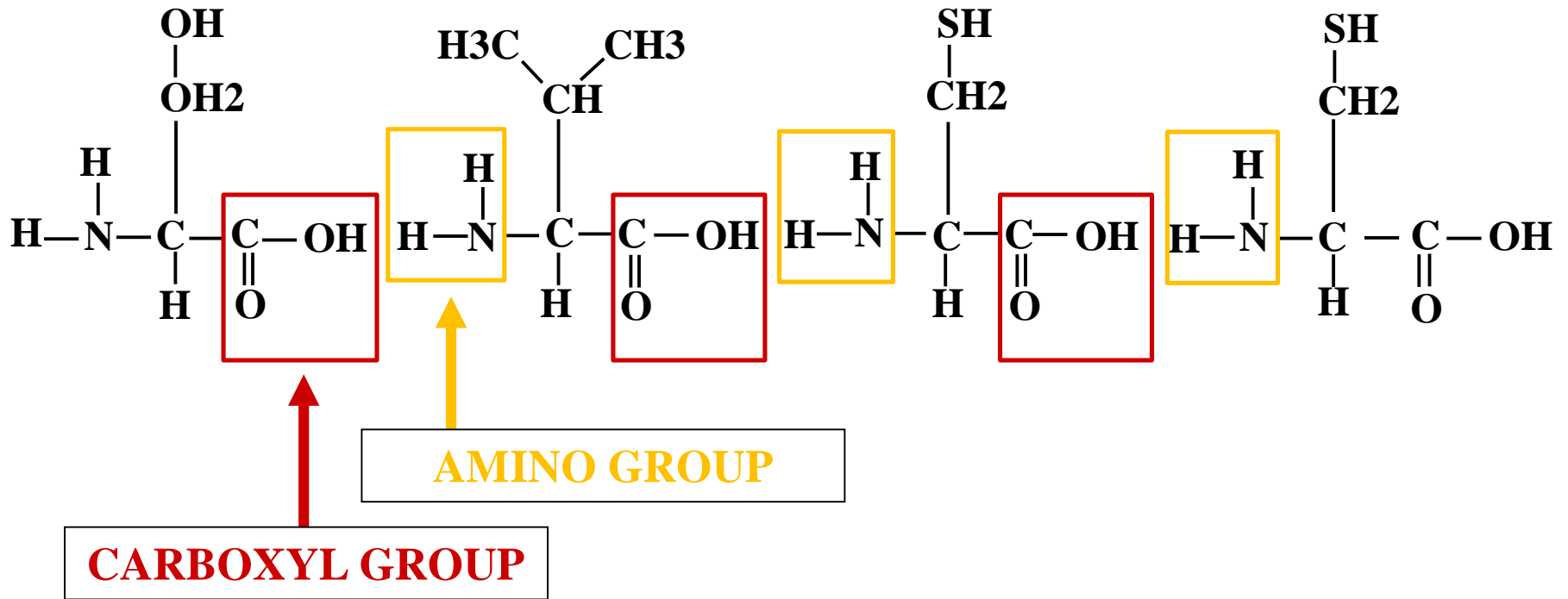

# PEPTIDE BOND

C ?  = AMINO ACID

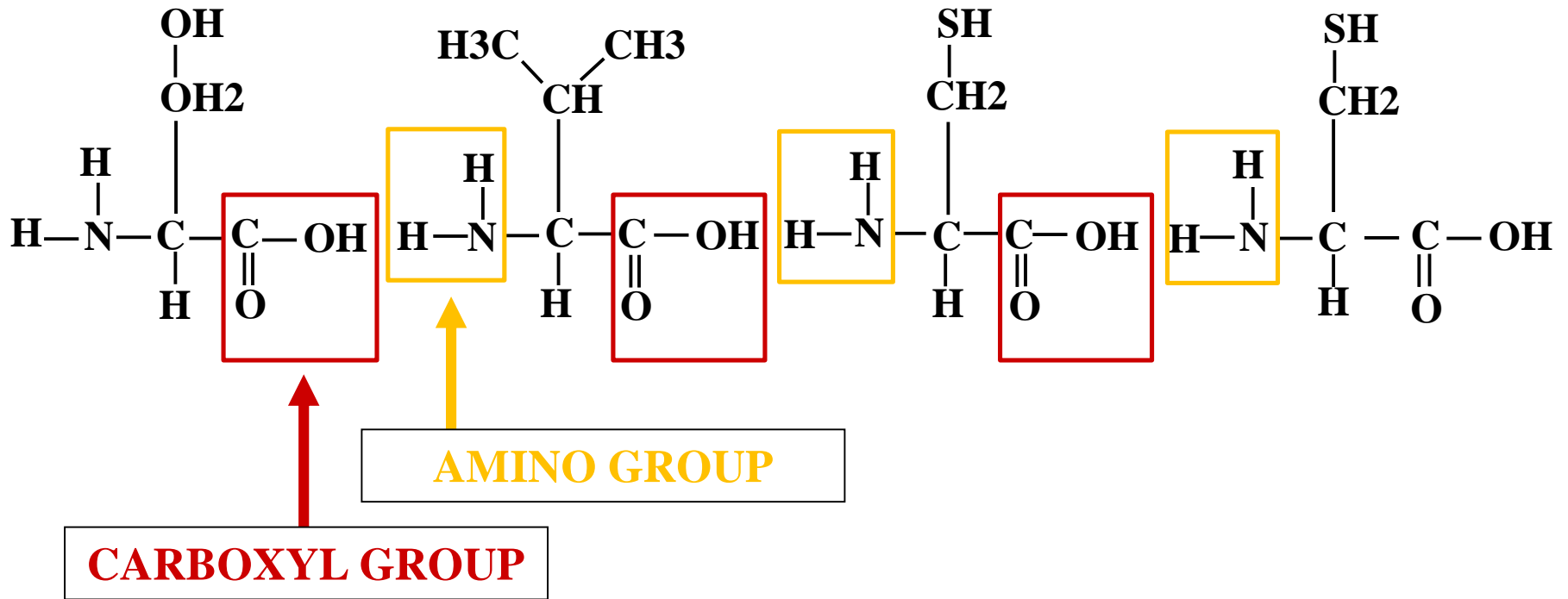

## COOH GROUP AND NH<sub>2</sub> GROUP INTERACT

# PEPTIDE BOND

**C**  = AMINO ACID

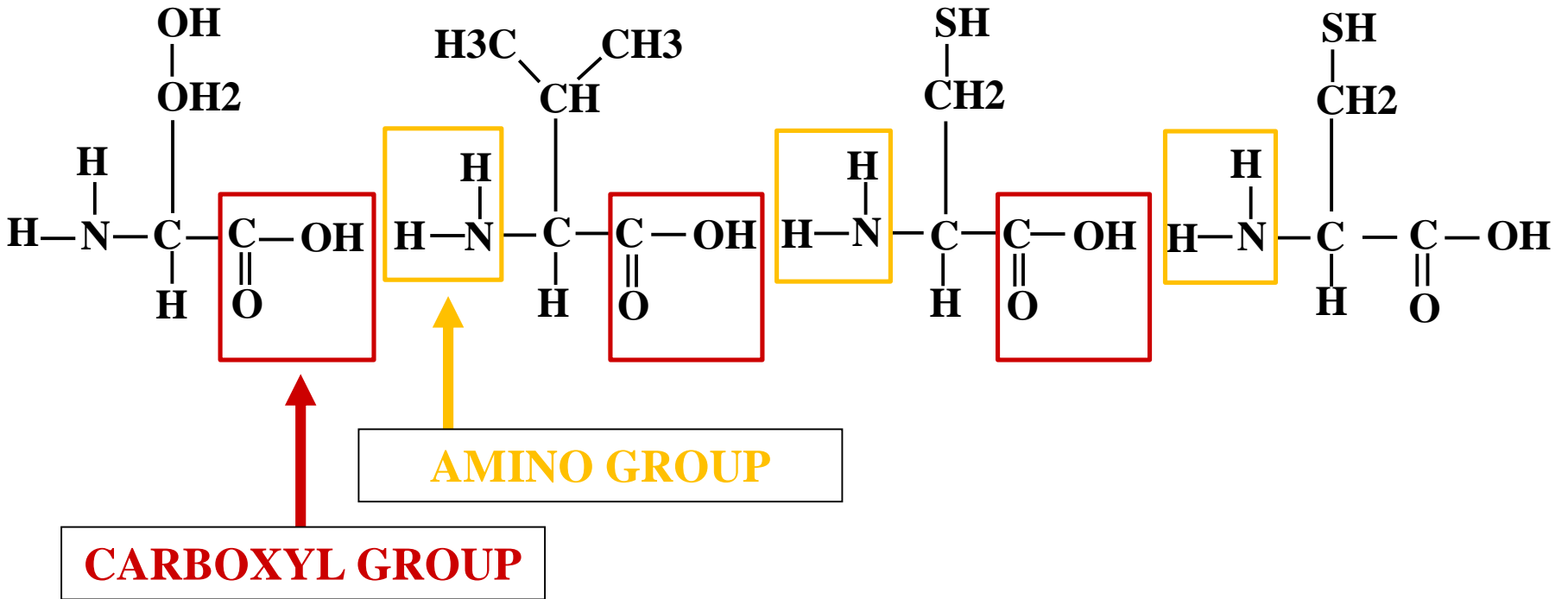

**?**  
**REACTION**

# PEPTIDE BOND

?    = AMINO ACID

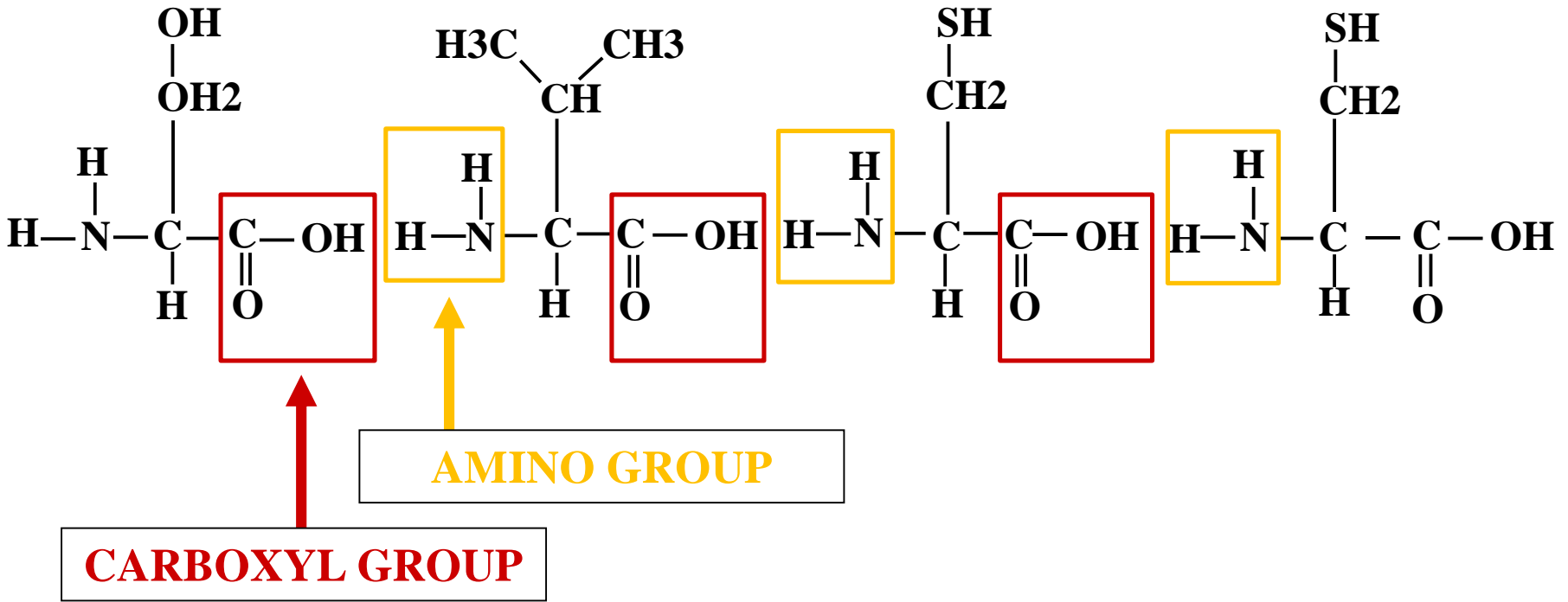

# CONDENSATION REACTION



# PEPTIDE BOND

**W**  = AMINO ACID

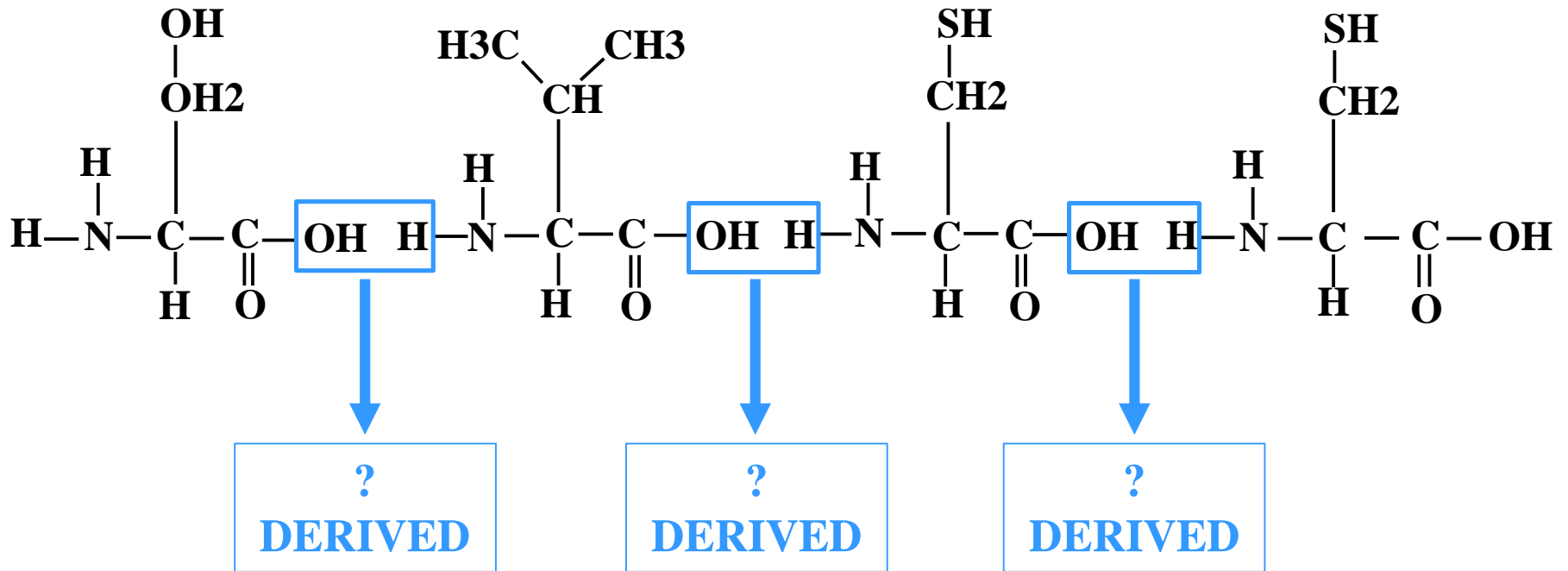

# CONDENSATION REACTION

# PEPTIDE BOND

\* ?  = AMINO ACID

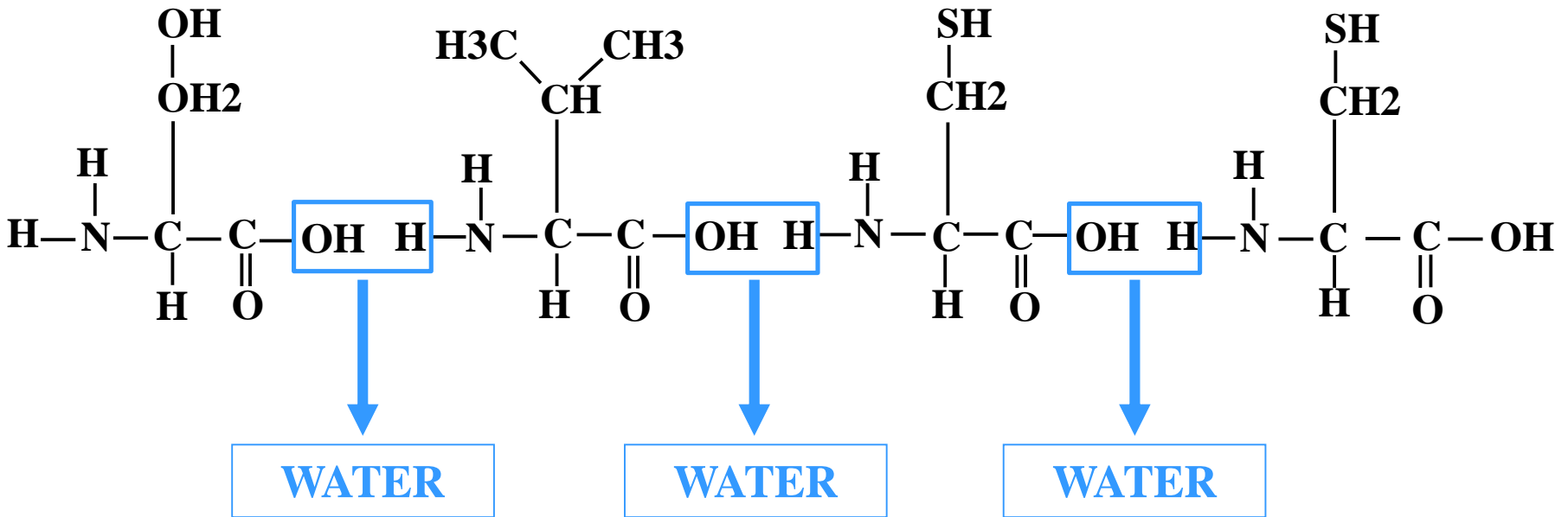

# CONDENSATION REACTION

# PEPTIDE BOND

**PB**

= AMINO ACID

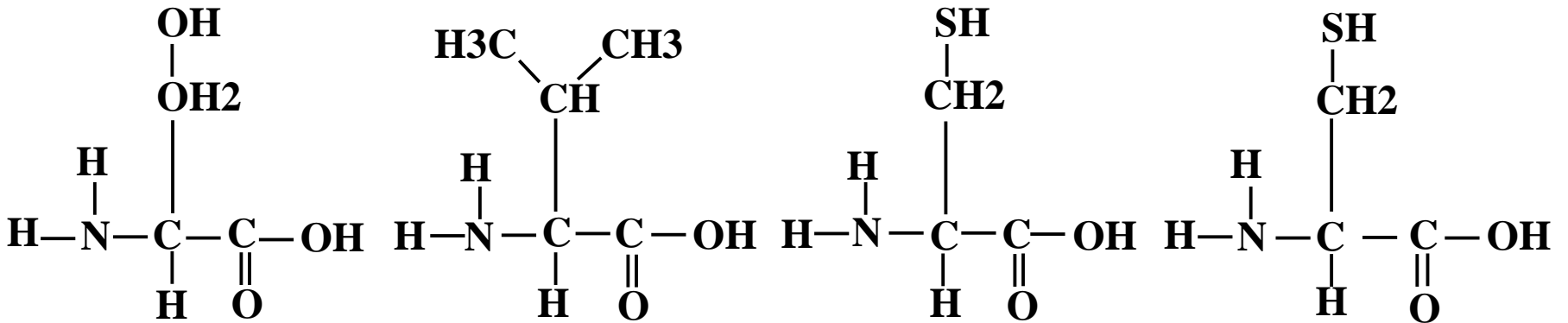

# ? BOND

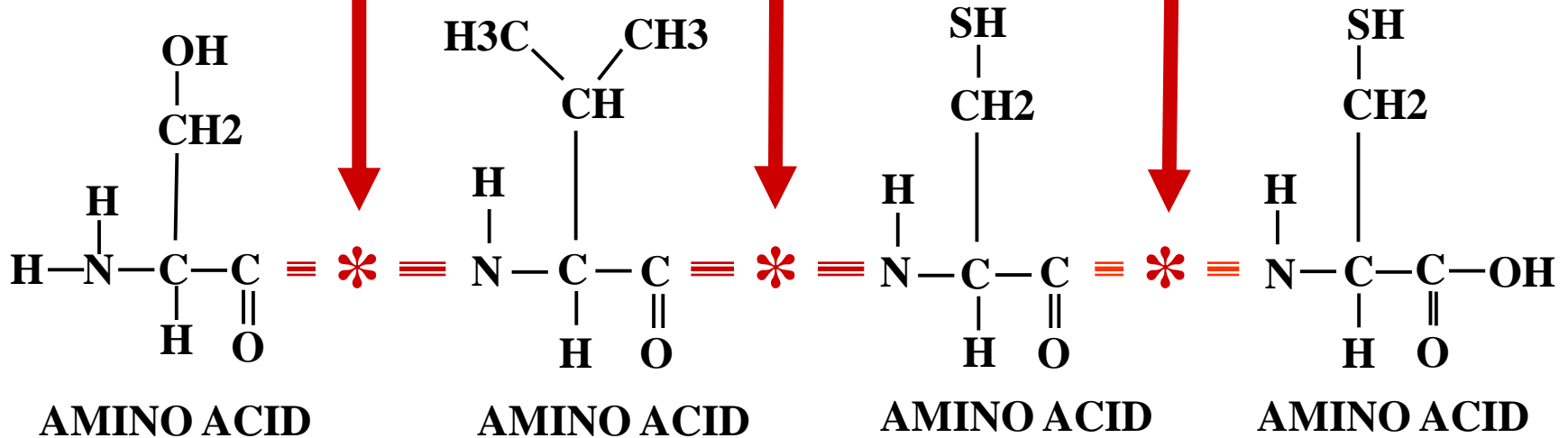

# PEPTIDE BOND

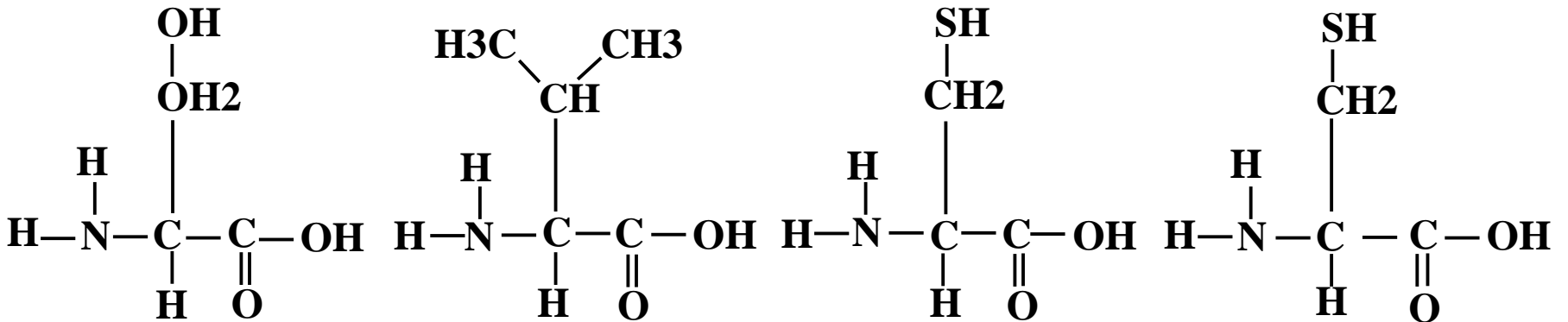
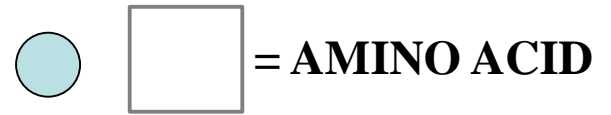

# PEPTIDE BOND

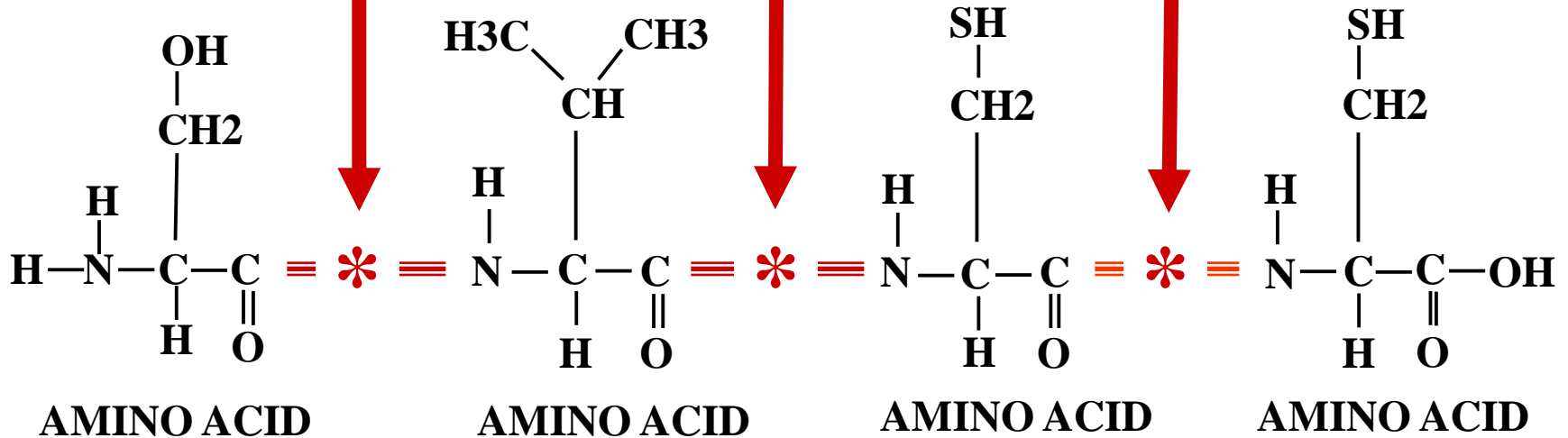



# PROTEIN AMINO ACID POLYMER

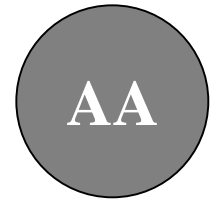
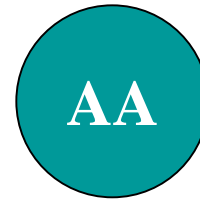
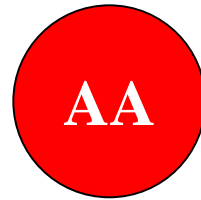
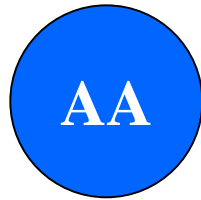
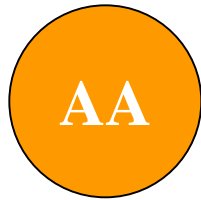
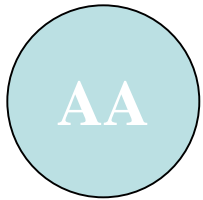

AMINO ACID

# PROTEIN AMINO ACID POLYMER

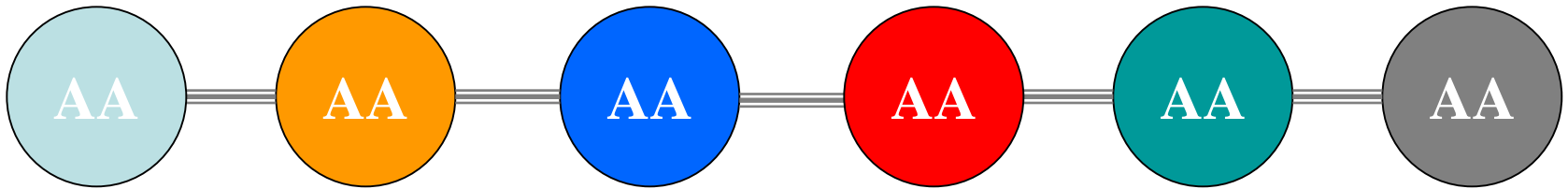

AMINO ACID  $\equiv$  = BOND ?

# PROTEIN

## AMINO ACID POLYMER

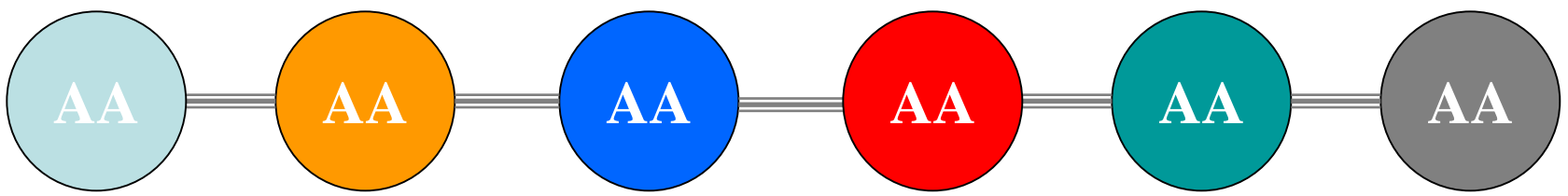

**AMINO ACID**    **==** = PEPTIDE BOND

# PROTEIN AMINO ACID POLYMER

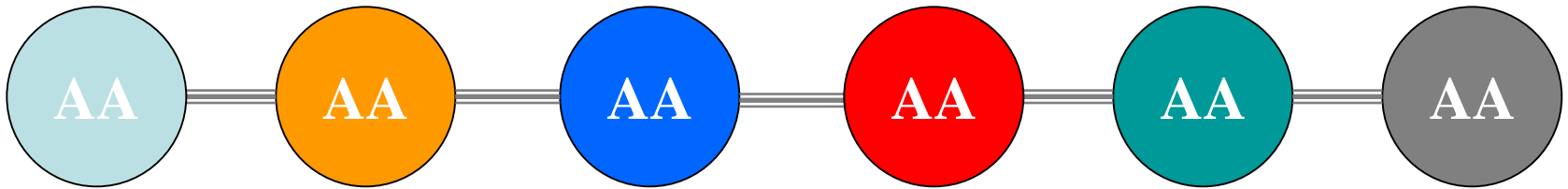

AMINO ACID    **==** = PEPTIDE BOND

?



# PROTEIN AMINO ACID POLYMER

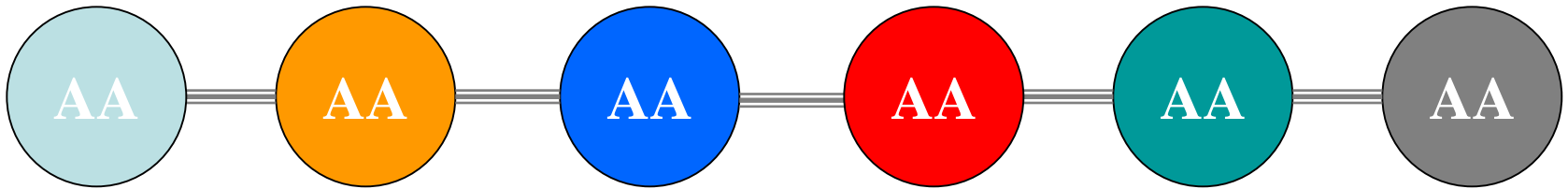

AMINO ACID    **==** = PEPTIDE BOND

**POLYPEPTIDE**

**POLYPEPTIDE**



**POLYPEPTIDE**

**MANY BONDED  
AMINO ACIDS**

**POLYPEPTIDE**

# PROTEIN

## AMINO ACID POLYMER

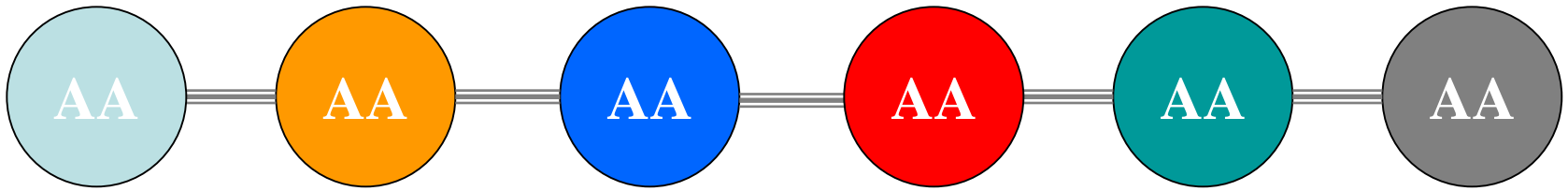

AMINO ACID    **==** = PEPTIDE BOND



# POLYPEPTIDE

# PROTEIN

## AMINO ACID POLYMER

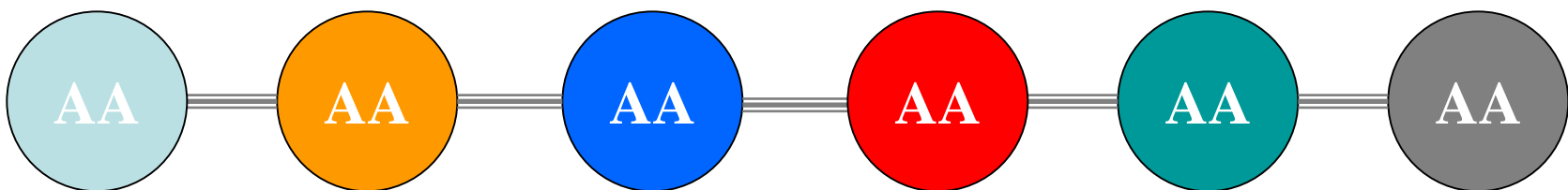

AMINO ACID    == = PEPTIDE BOND



**POLYPEPTIDE = PROTEIN**

**POLYPEPTIDE**

**SYNONYMOUS**

**PROTEIN**



# PROTEIN STRUCTURE

# PROTEIN ENZYME COMPUTER GENERATED MODEL

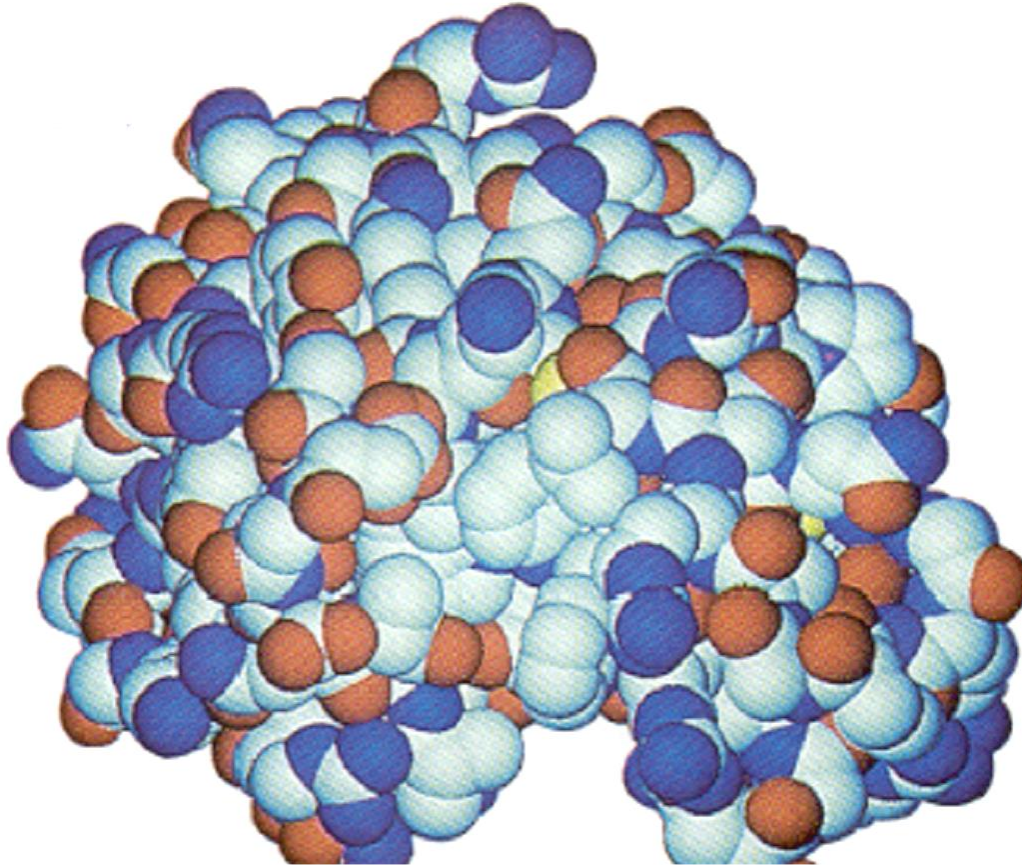

**PROTEIN**



# PROTEIN ENZYME COMPUTER GENERATED MODEL

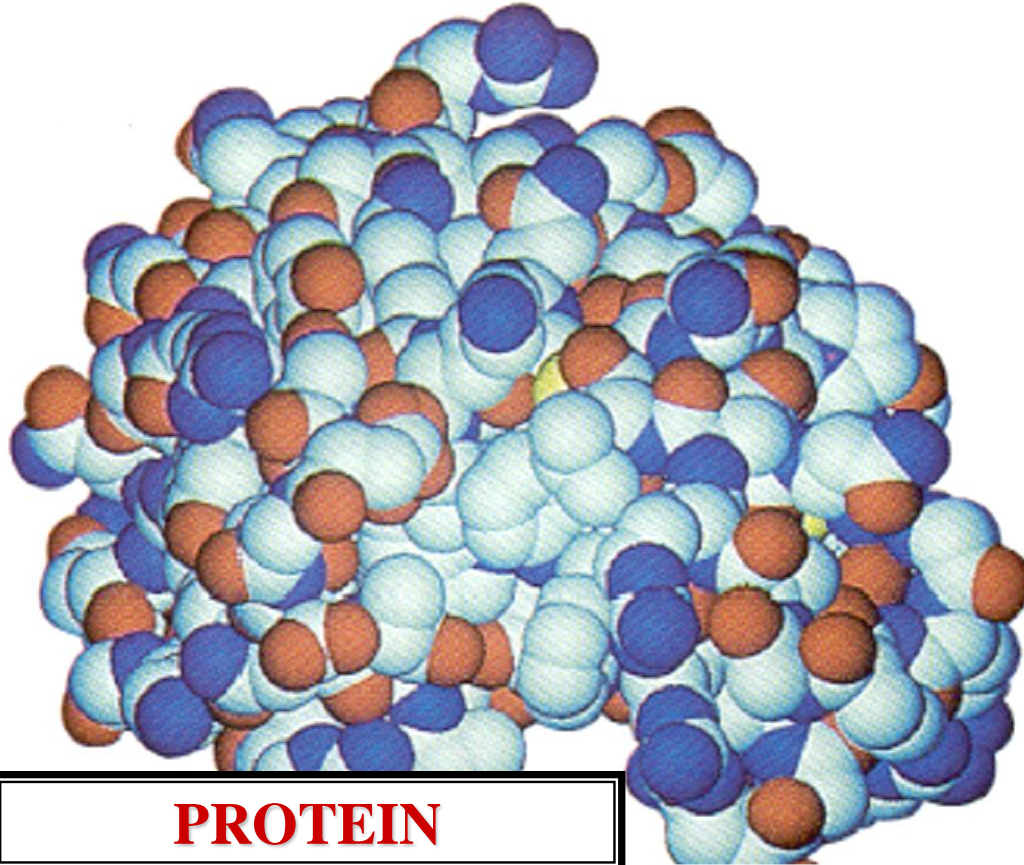

**PROTEIN**

**HIGHLY COMPLEX**

# PROTEIN ENZYME COMPUTER GENERATED MODEL

~1

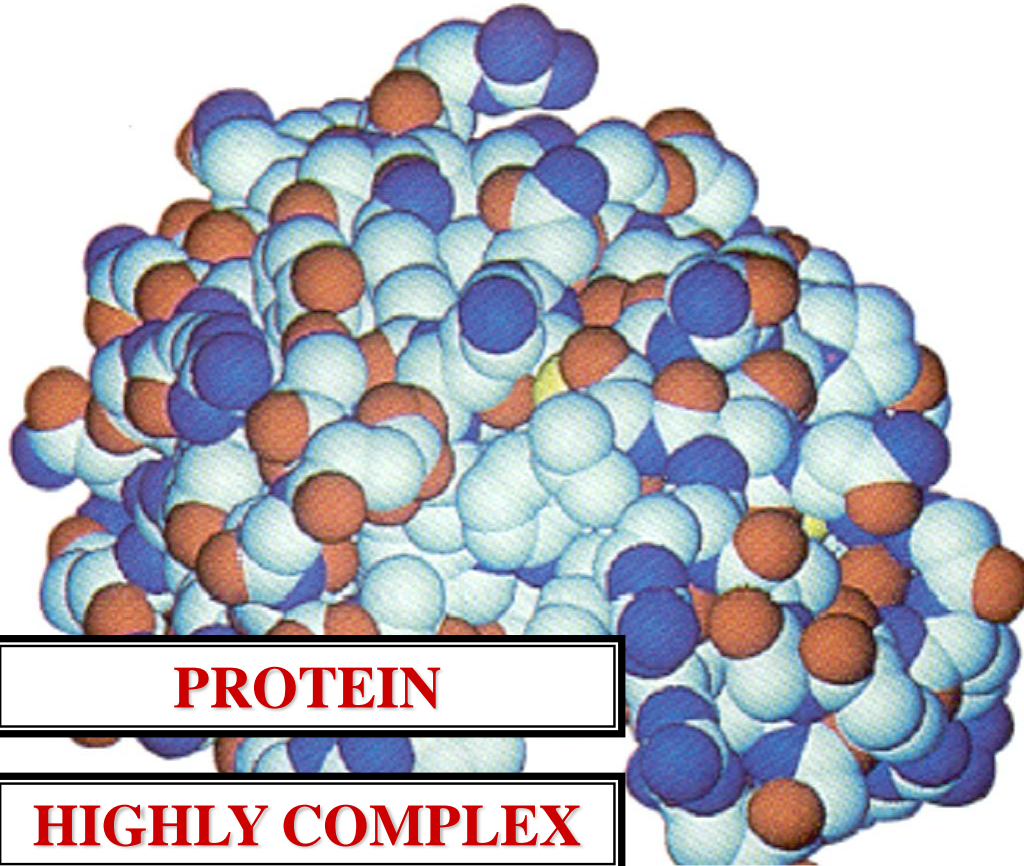

**PROTEIN**

**HIGHLY COMPLEX**

**4 STRUCTURAL LEVELS**

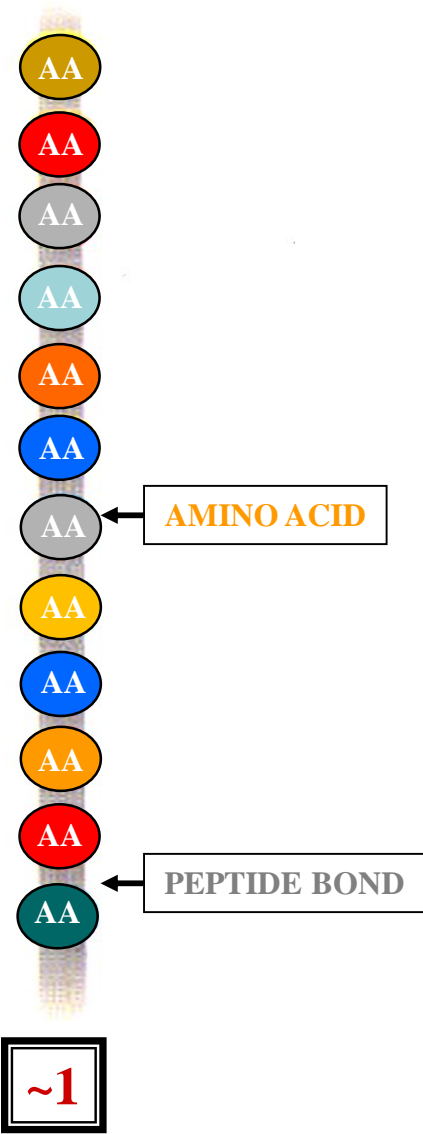

# PROTEIN STRUCTURE

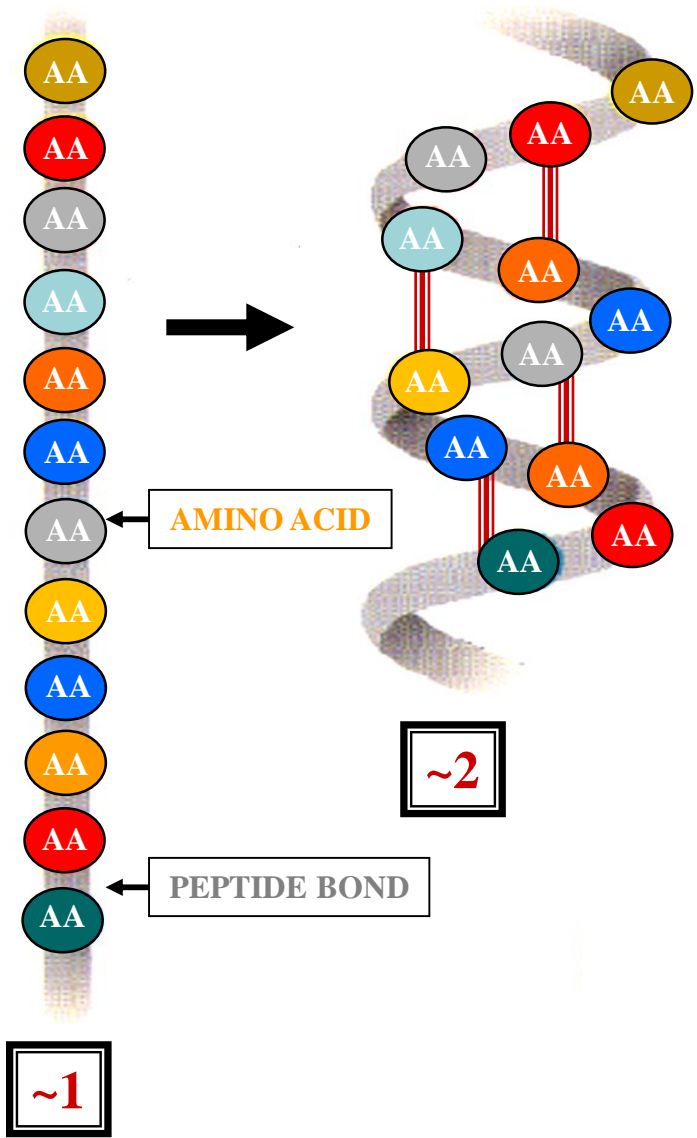

# PROTEIN STRUCTURE

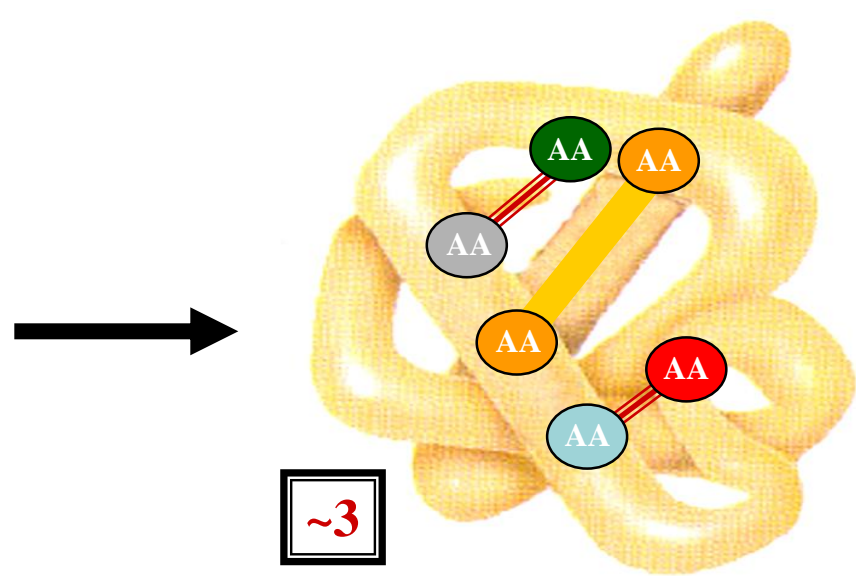
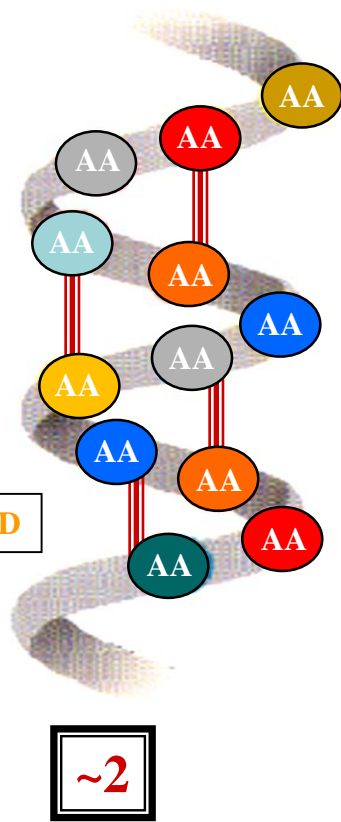
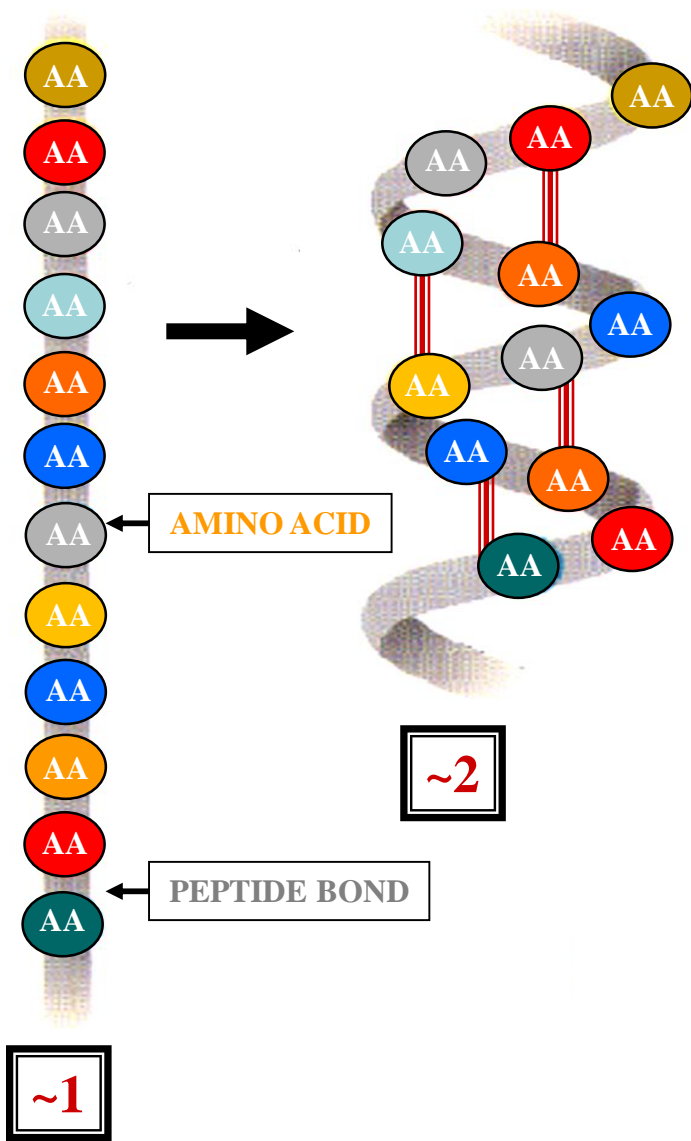

~4

# PROTEIN STRUCTURE

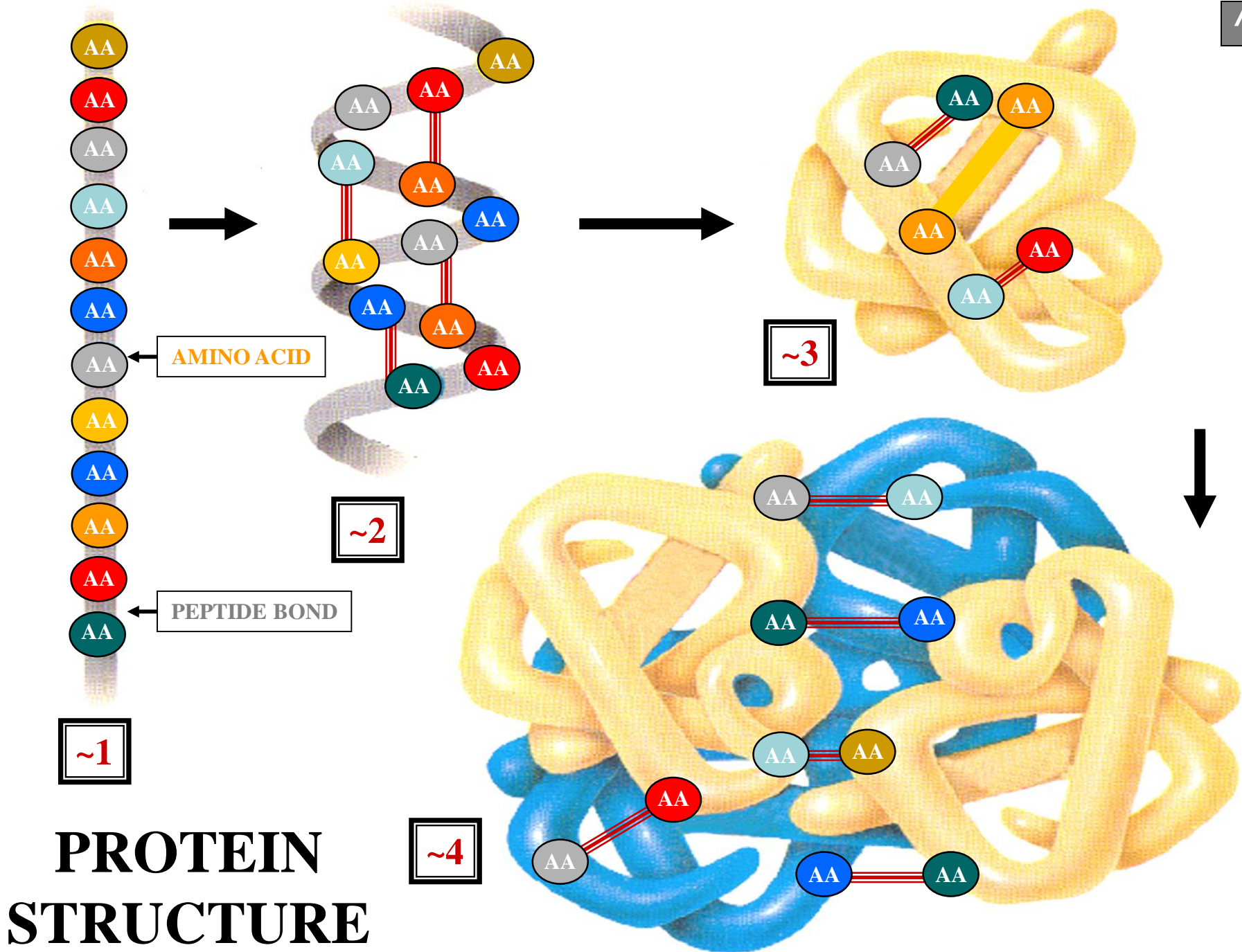

# PROTEIN STRUCTURE

# PROTEIN PRIMARY STRUCTURE

**PROTEIN  
PRIMARY  
STRUCTURE**





**PROTEIN ~1 STRUCTURE**

**LINEAR  
AMINO ACID  
SEQUENCE**

**PROTEIN ~1 STRUCTURE**

# PROTEIN STRUCTURE

## PRIMARY STRUCTURE

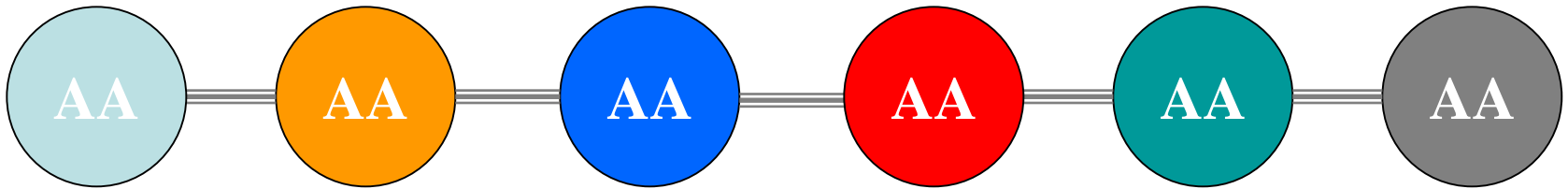

== = BOND

**LINEAR AMINO ACID SEQUENCE**

# PROTEIN STRUCTURE

## PRIMARY STRUCTURE

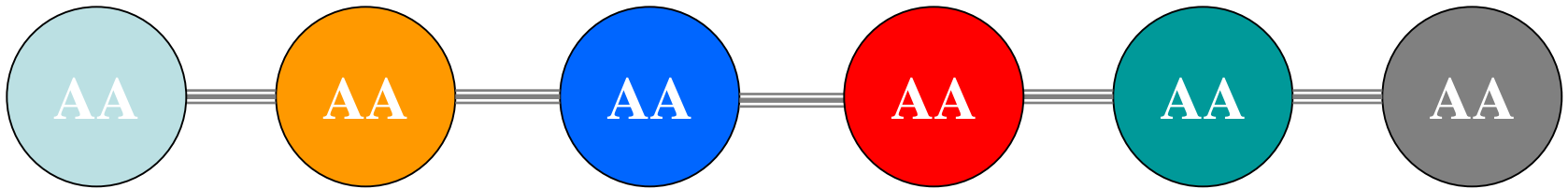

== = PEPTIDE BOND

**LINEAR AMINO ACID SEQUENCE**

# PROTEIN STRUCTURE

## PRIMARY STRUCTURE

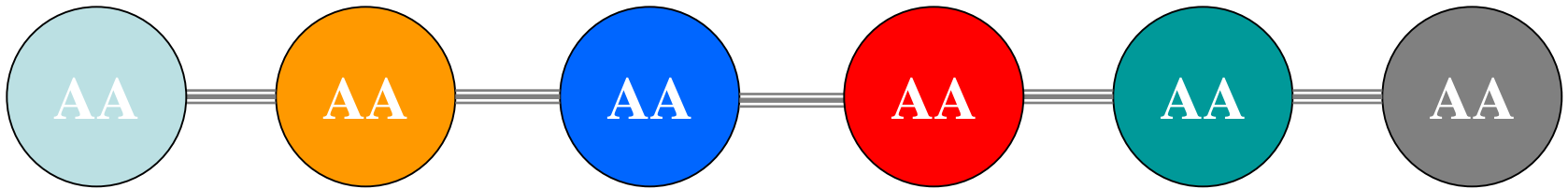

== = PEPTIDE BOND

**LINEAR AMINO ACID SEQUENCE**

**POLYPEPTIDE**

# PROTEIN STRUCTURE



## PRIMARY STRUCTURE

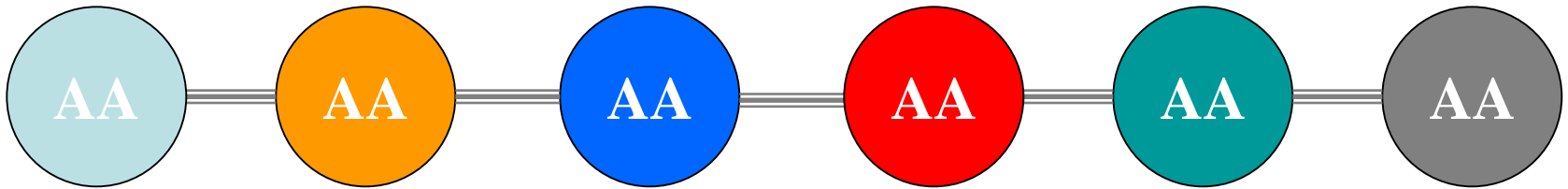

== = PEPTIDE BOND

**LINEAR AMINO ACID SEQUENCE**

**POLYPEPTIDE = PRIMARY STRUCTURE**

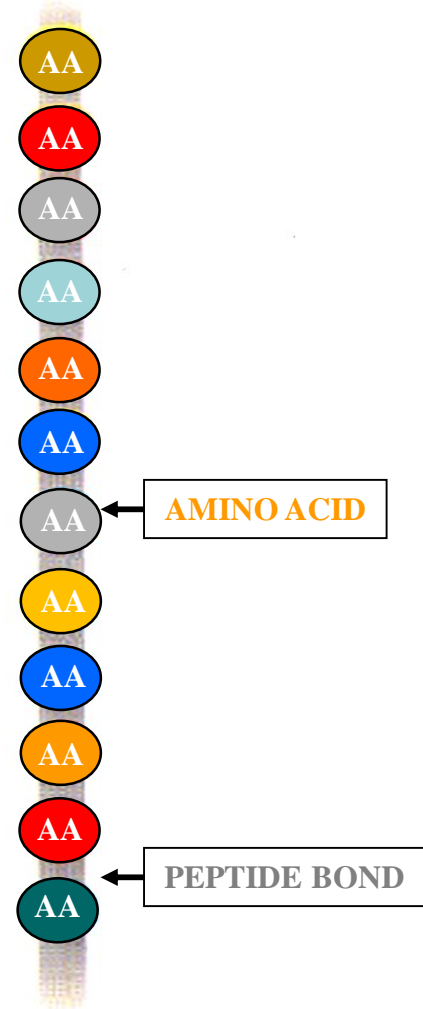

~1

LINEAR AMINO ACID SEQUENCE = POLYPEPTIDE

— = PEPTIDE BOND

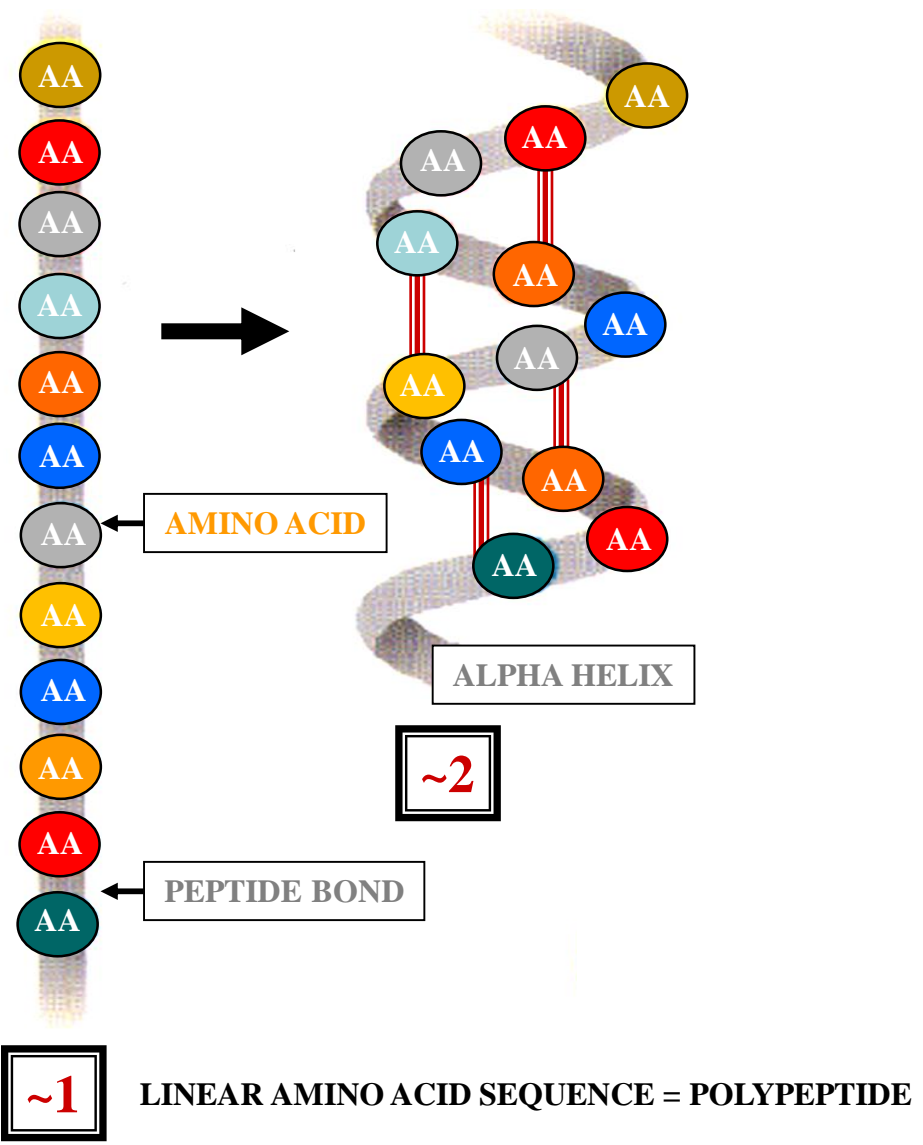

— = PEPTIDE BOND

== = H-BOND

# PROTEIN SECONDARY STRUCTURE



**PROTEIN  
SECONDARY  
STRUCTURE**



**PROTEIN ~2 STRUCTURE**

**POLYPEPTIDE  
TWISTS & FOLDS**

**PROTEIN ~2 STRUCTURE**

# PROTEIN STRUCTURE

## PRIMARY STRUCTURE

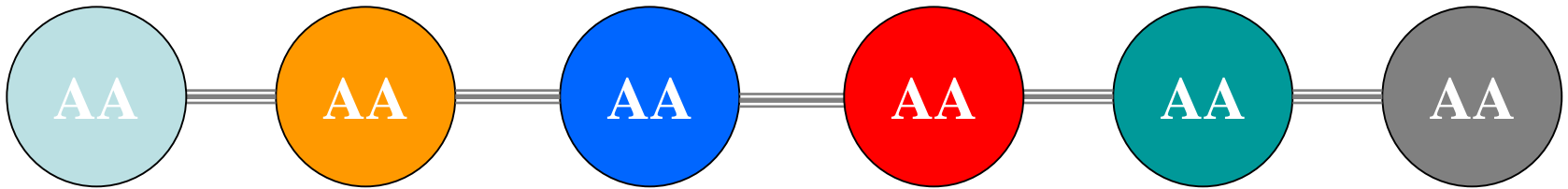

== = PEPTIDE BOND

**POLYPEPTIDE = PRIMARY STRUCTURE**

# PROTEIN STRUCTURE

## SECONDARY STRUCTURE

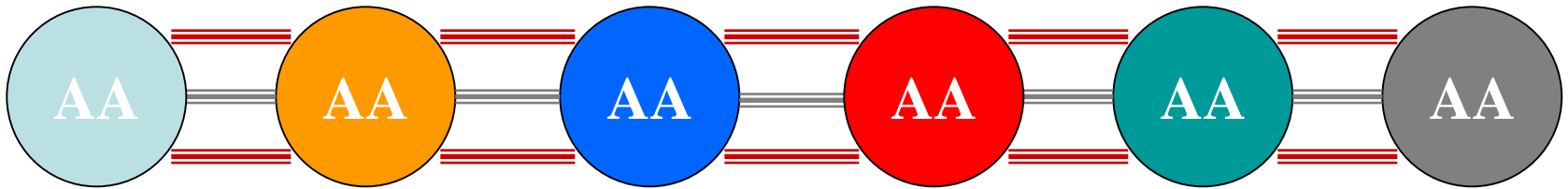

== = **HYDROGEN BOND**

== = **PEPTIDE BOND**

**POLYPEPTIDE = PRIMARY STRUCTURE**

**HELICAL TWIST  
OR  
PARALLEL FOLDS**



**HELICAL TWIST**

**=**

**ALPHA HELIX**

# PROTEIN STRUCTURE

## SECONDARY STRUCTURE

● = AMINO ACID

**POLYPEPTIDE**

**AMINO  
ACID**

**HYDROGEN  
BONDS**

**HELICAL TWIST**

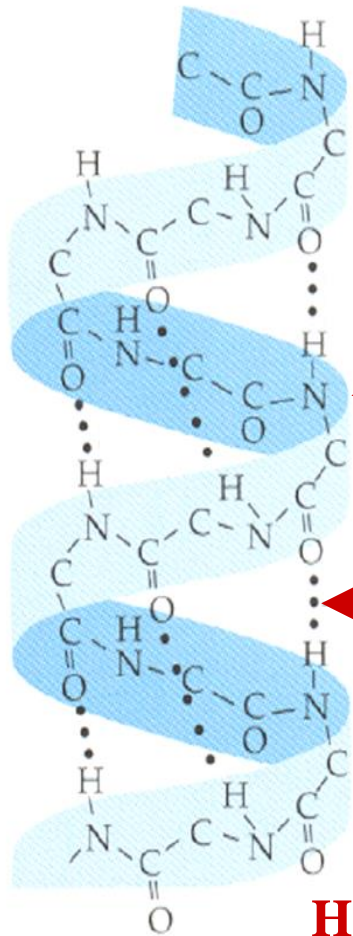

# PROTEIN STRUCTURE

## SECONDARY STRUCTURE

● = AMINO ACID

**POLYPEPTIDE**

**AMINO  
ACID**

**HYDROGEN  
BONDS**

**ALPHA HELIX**

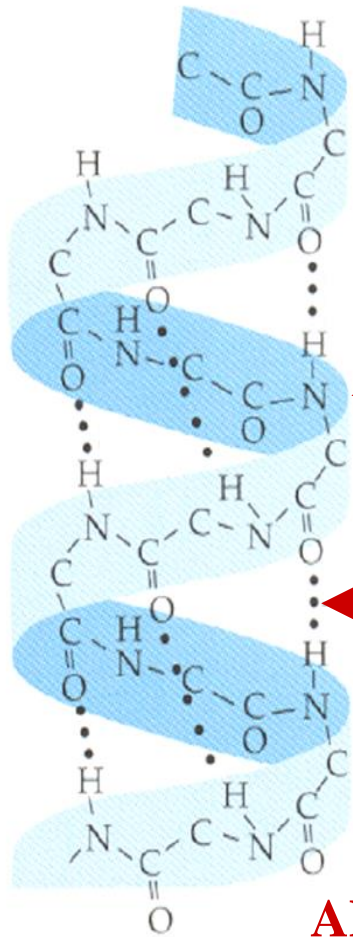





**PARALLEL FOLDS**

**=**

**BETA SHEET**

# PROTEIN STRUCTURE

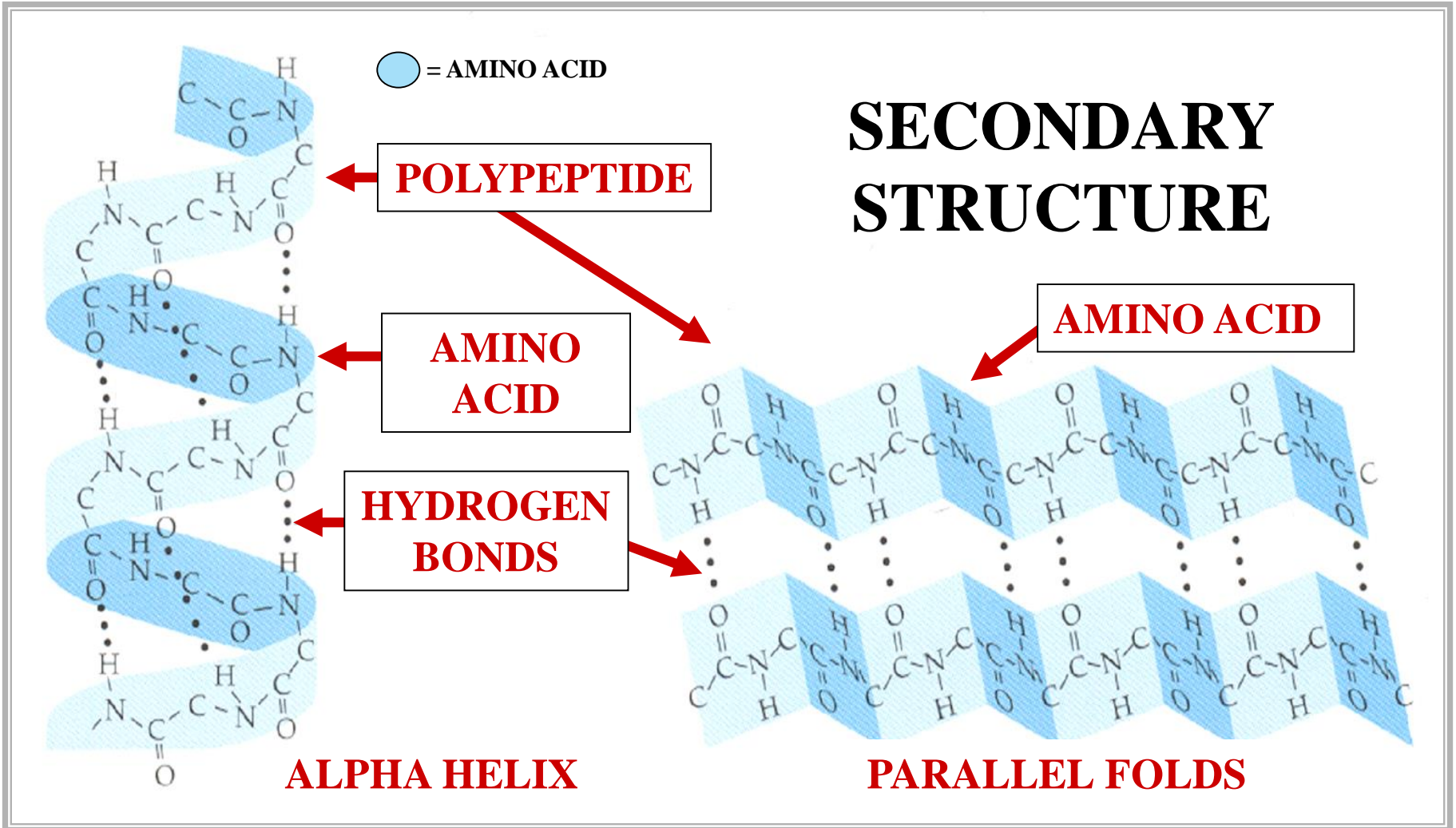

# PROTEIN STRUCTURE

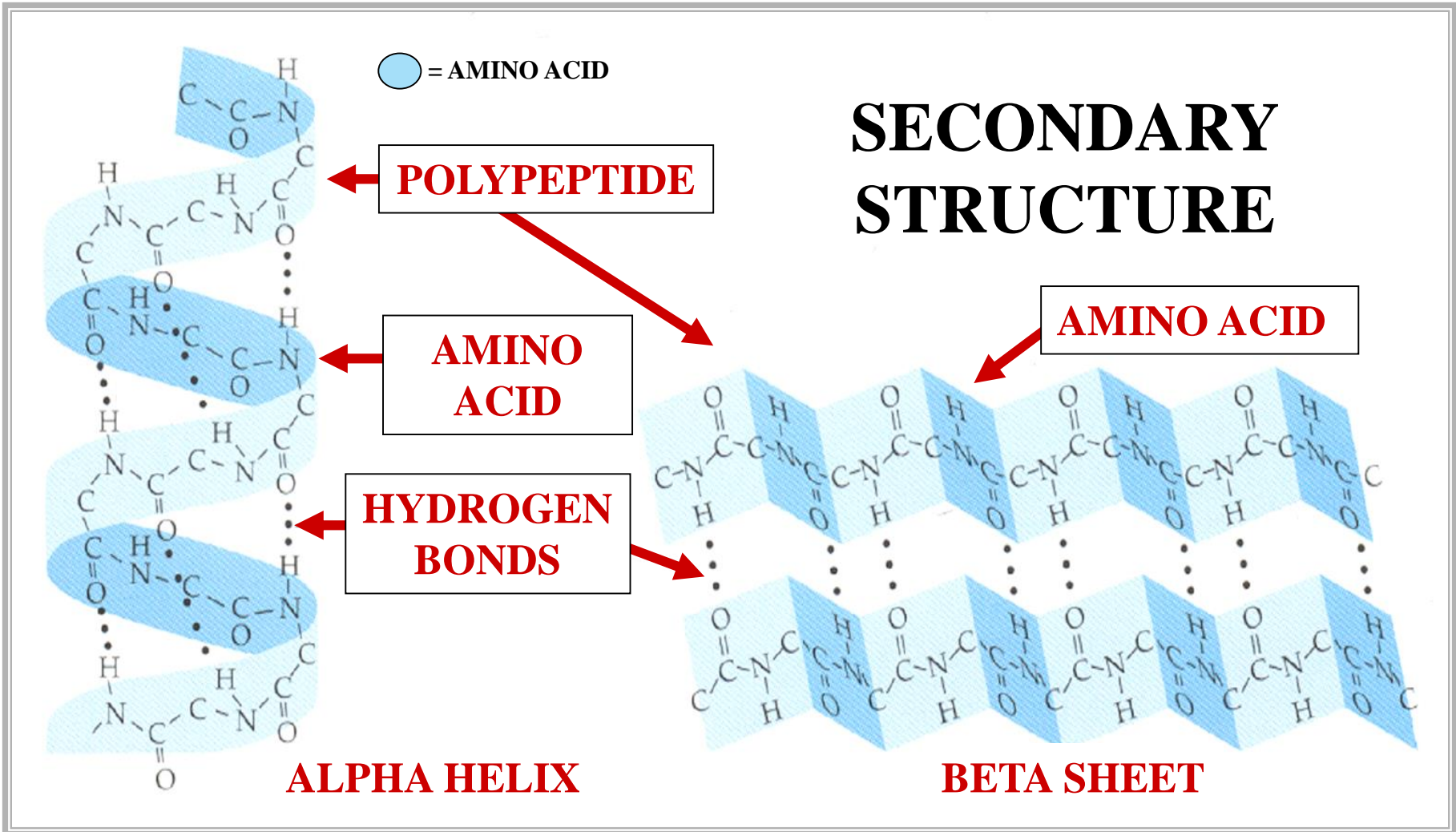



**PROTEIN  
SECONDARY  
STRUCTURE  
SUMMARY**

# PROTEIN STRUCTURE

## PRIMARY STRUCTURE

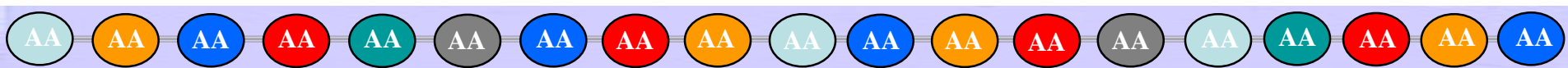

 = POLYPEPTIDE

 = AMINO ACID     = PEPTIDE BOND

# PROTEIN STRUCTURE

## SECONDARY STRUCTURE

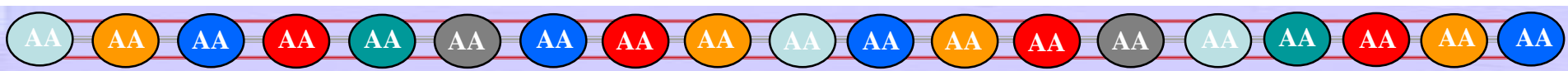

 = POLYPEPTIDE

 = AMINO ACID — = HYDROGEN BOND

# PROTEIN STRUCTURE

A&B

+

## SECONDARY STRUCTURE

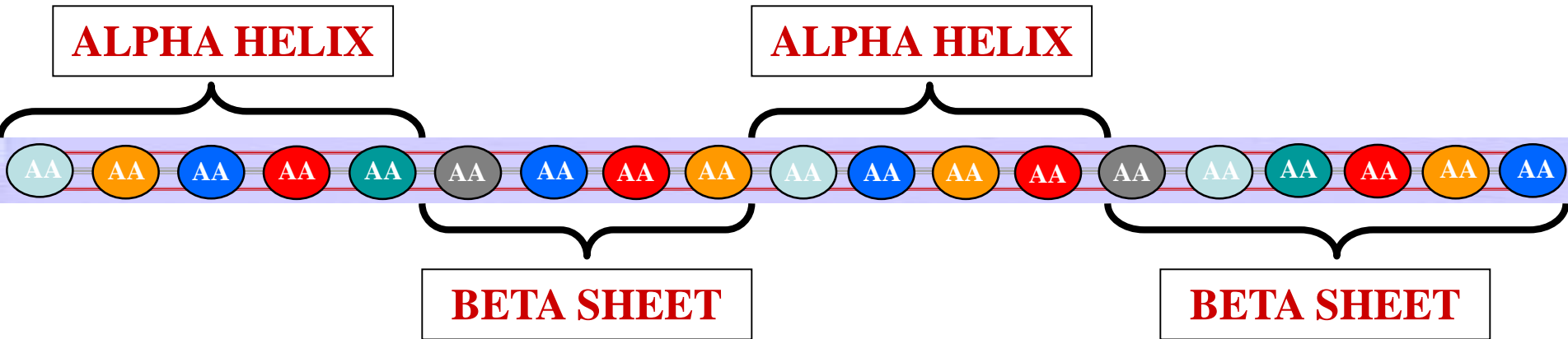

 = POLYPEPTIDE

 = AMINO ACID — = HYDROGEN BOND

# PROTEIN STRUCTURE



## SECONDARY STRUCTURE

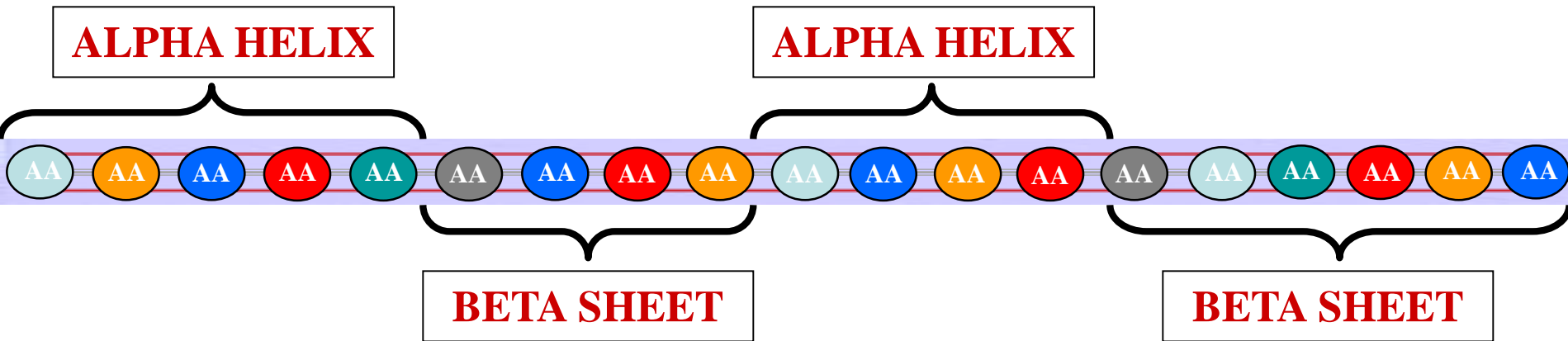

 = POLYPEPTIDE

 = AMINO ACID — = HYDROGEN BOND

ALPHA & BETA OCCUR SAME POLYPEPTIDE



# PROTEIN STRUCTURE



## SECONDARY STRUCTURE

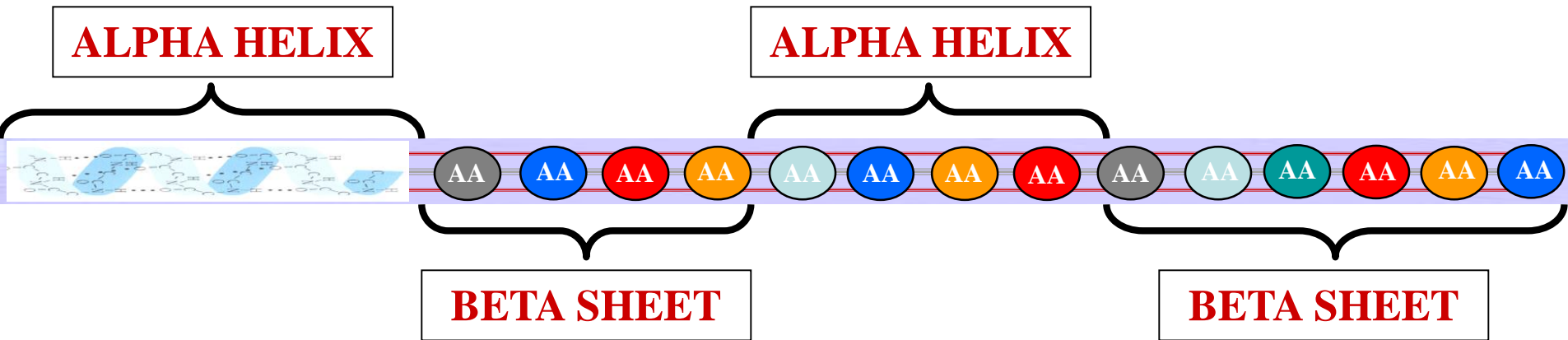

 = POLYPEPTIDE

 = AMINO ACID — = HYDROGEN BOND

ALPHA & BETA OCCUR SAME POLYPEPTIDE

# PROTEIN STRUCTURE



## SECONDARY STRUCTURE

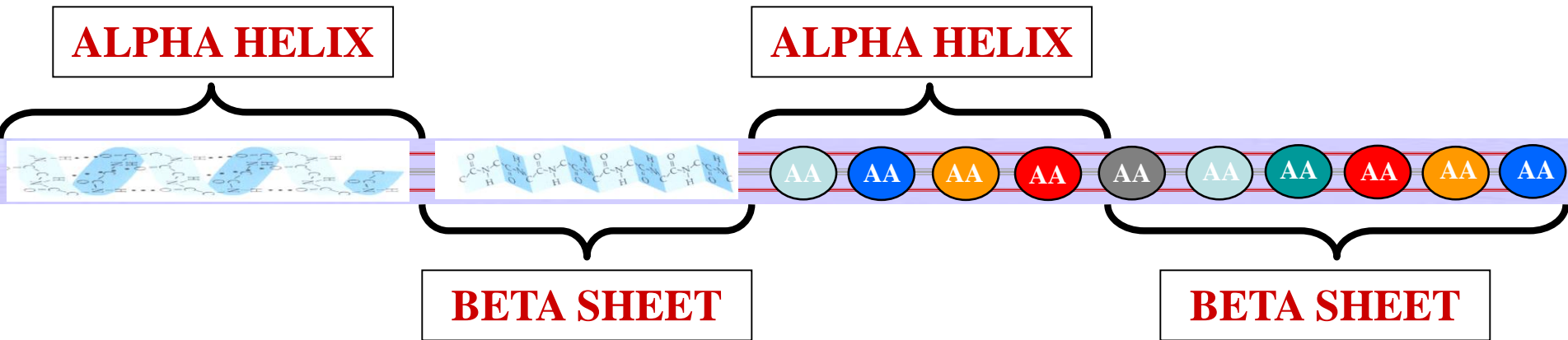

 = POLYPEPTIDE

 = AMINO ACID — = HYDROGEN BOND

ALPHA & BETA OCCUR SAME POLYPEPTIDE

# PROTEIN STRUCTURE



## SECONDARY STRUCTURE

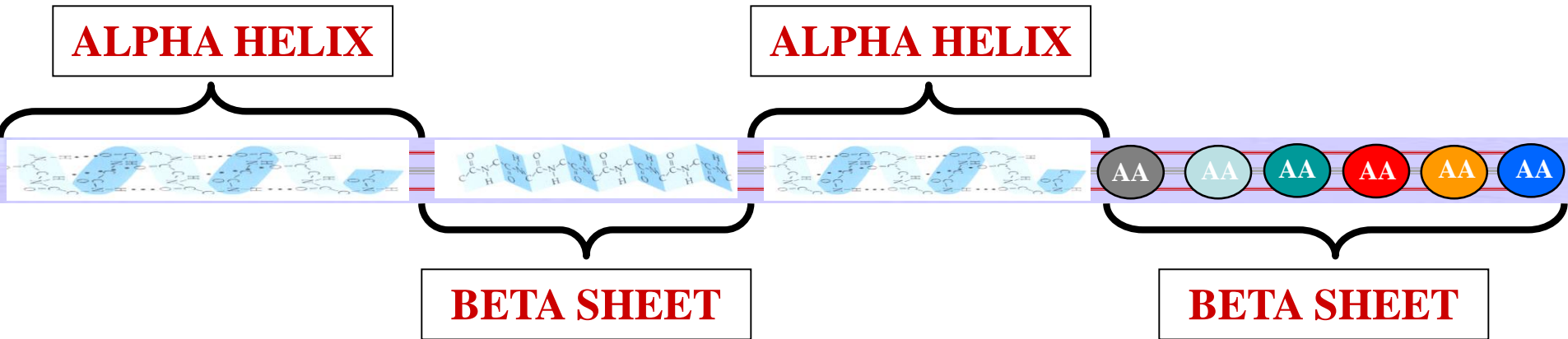

 = POLYPEPTIDE

 = AMINO ACID — = HYDROGEN BOND

ALPHA & BETA OCCUR SAME POLYPEPTIDE

# PROTEIN STRUCTURE



~2

## SECONDARY STRUCTURE

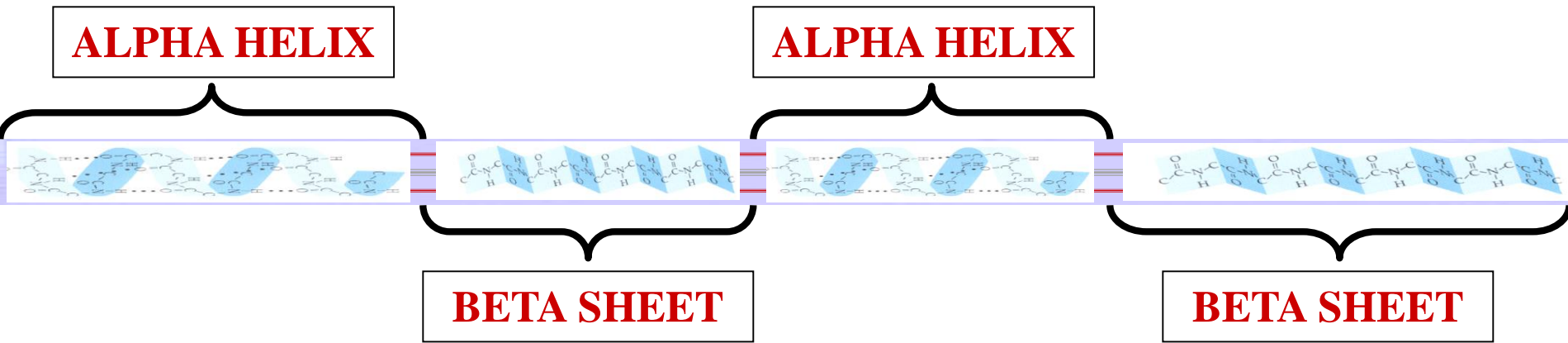

 = POLYPEPTIDE

 = AMINO ACID — = HYDROGEN BOND

ALPHA & BETA OCCUR SAME POLYPEPTIDE

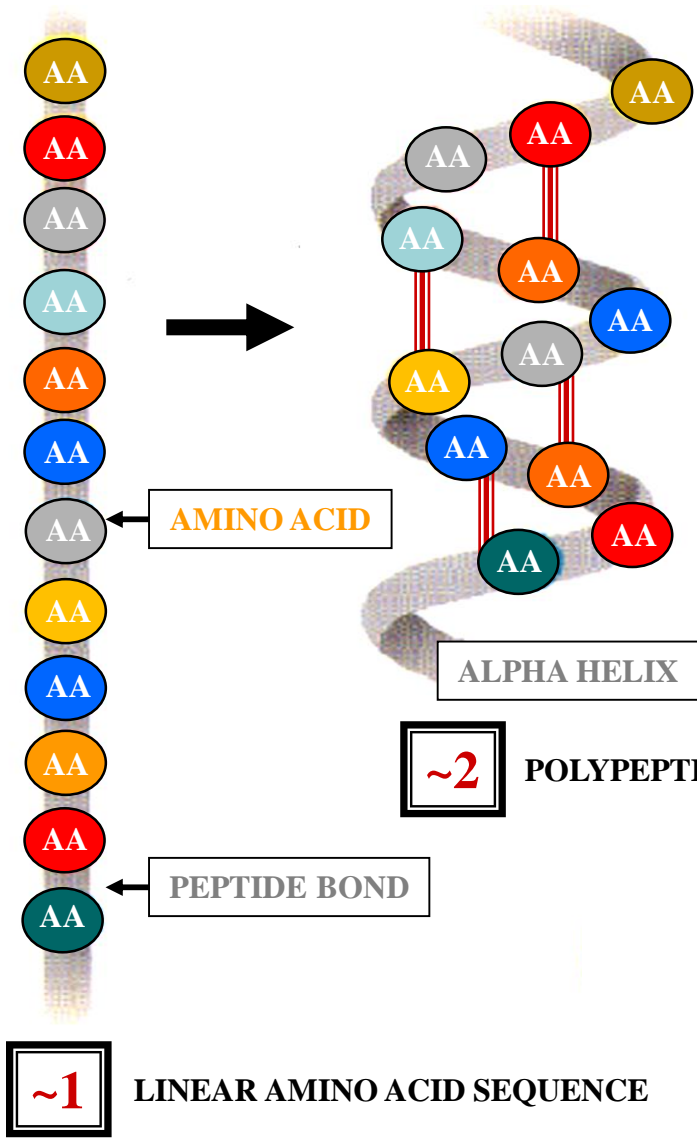

— = PEPTIDE BOND

== = H-BOND

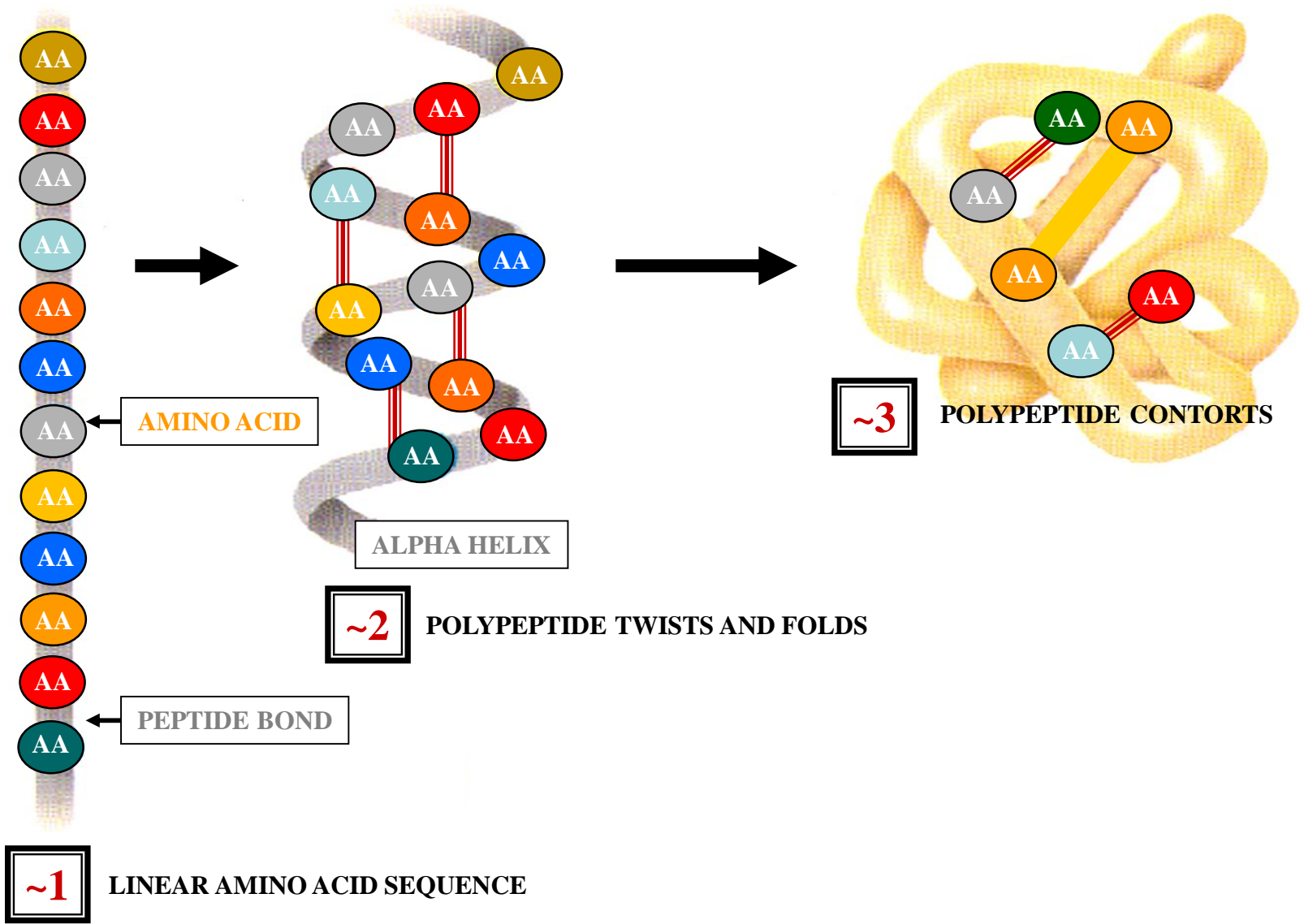

— = PEPTIDE BOND

== = H-BOND

# PROTEIN TERTIARY STRUCTURE

**PROTEIN  
TERTIARY  
STRUCTURE**



**PROTEIN ~3 STRUCTURE**

**POLYPEPTIDE  
CONTORTS**

**PROTEIN ~3 STRUCTURE**

# PROTEIN STRUCTURE

## PRIMARY STRUCTURE

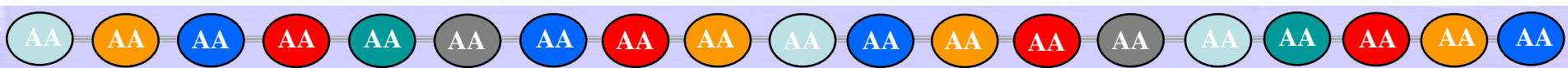

 = POLYPEPTIDE

 = AMINO ACID     = PEPTIDE BOND

# PROTEIN STRUCTURE

## PRIMARY STRUCTURE

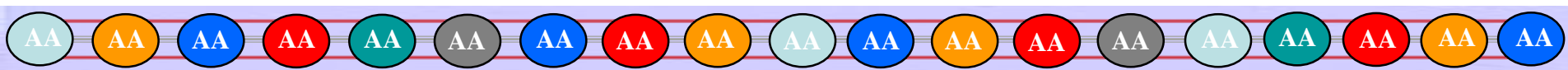

 = POLYPEPTIDE

 = AMINO ACID — = HYDROGEN BOND

# PROTEIN STRUCTURE

## SECONDARY STRUCTURE

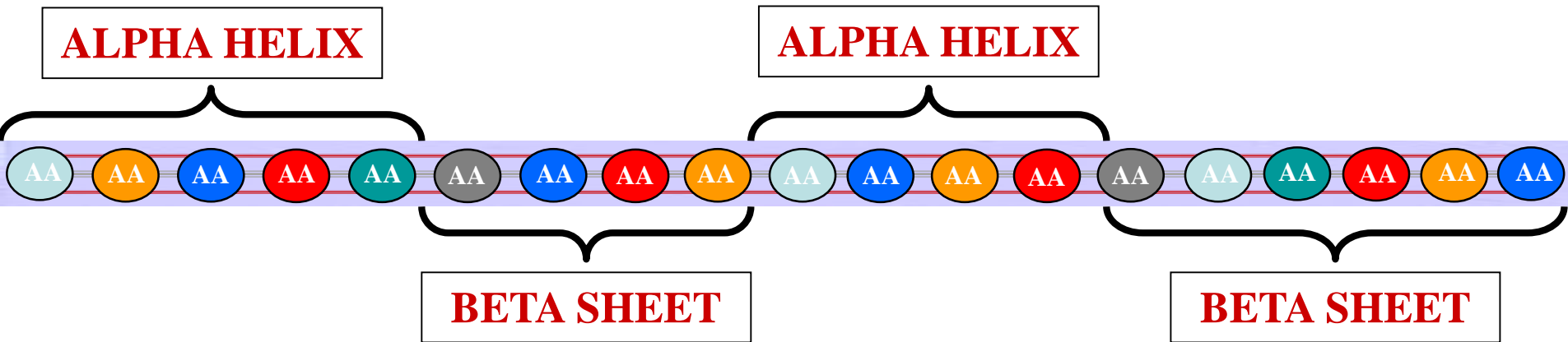

 = POLYPEPTIDE

 = AMINO ACID — = HYDROGEN BOND

# PROTEIN STRUCTURE

## TERTIARY STRUCTURE

○ = AMINO ACID

■ = POLYPEPTIDE

**ALPHA HELIX**

**BETA SHEET**

**CONTORTED  
POLYPEPTIDE**

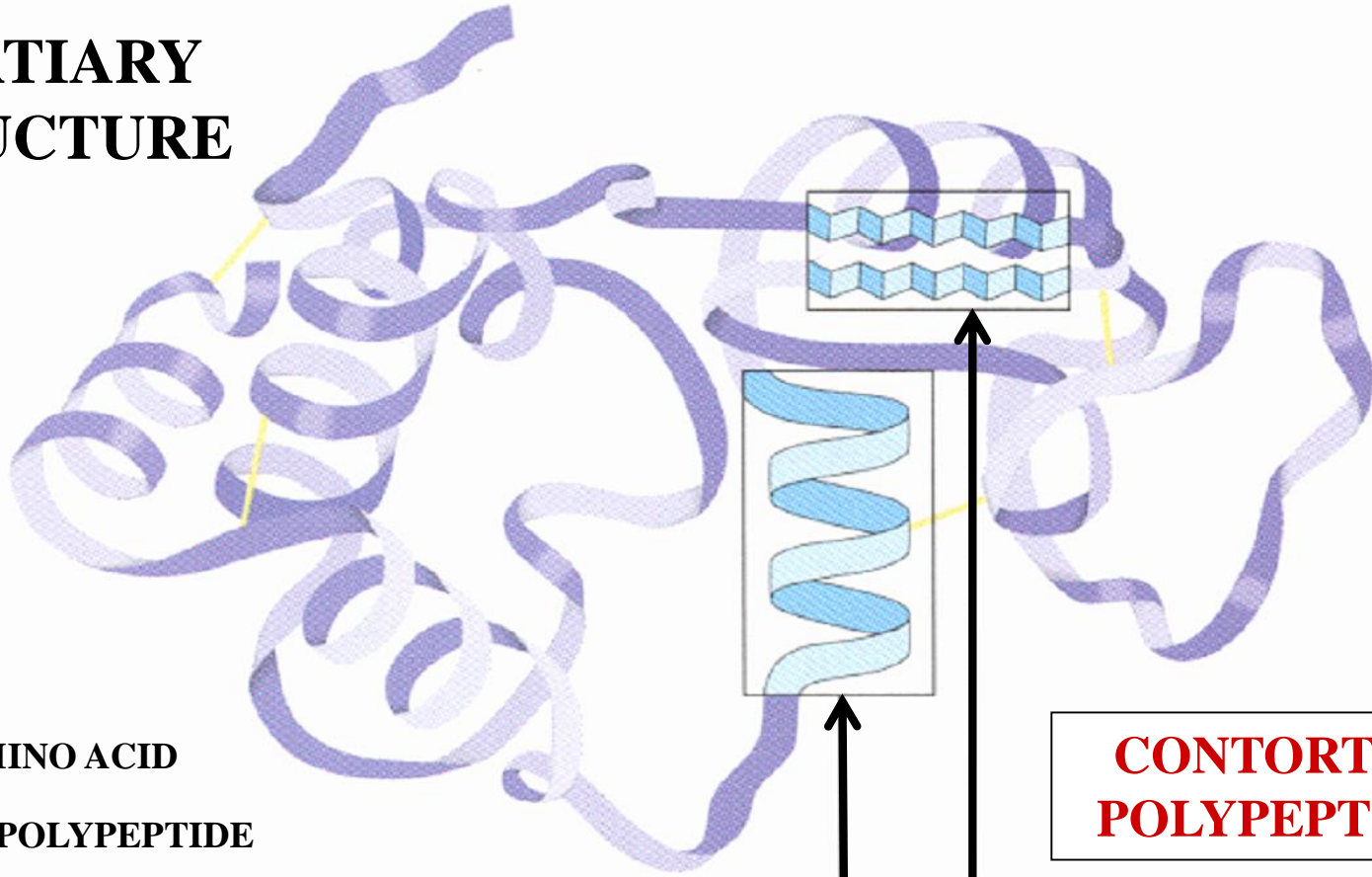

# PROTEIN STRUCTURE



## TERTIARY STRUCTURE

== = HYDROGEN BOND

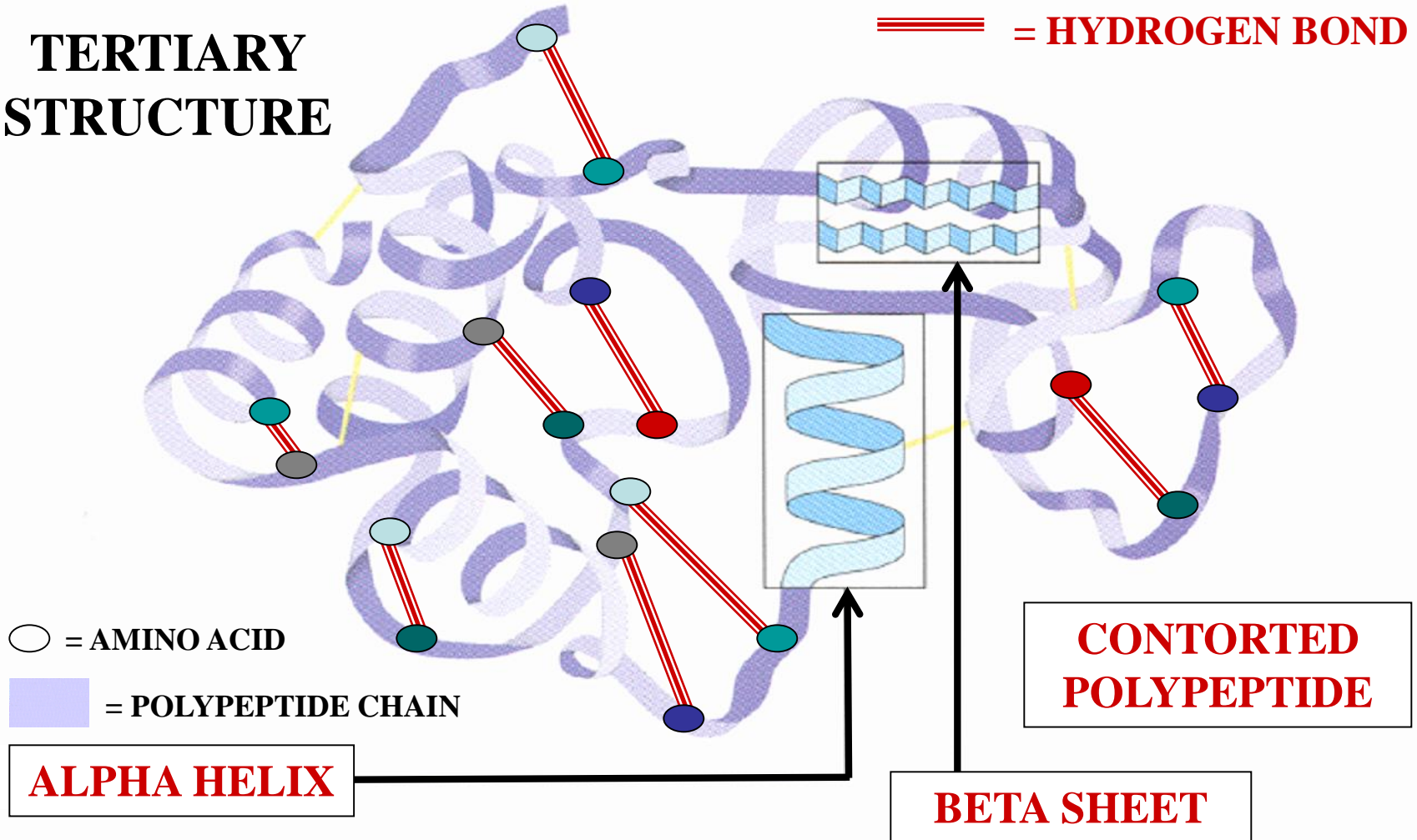

# PROTEIN STRUCTURE

## TERTIARY STRUCTURE

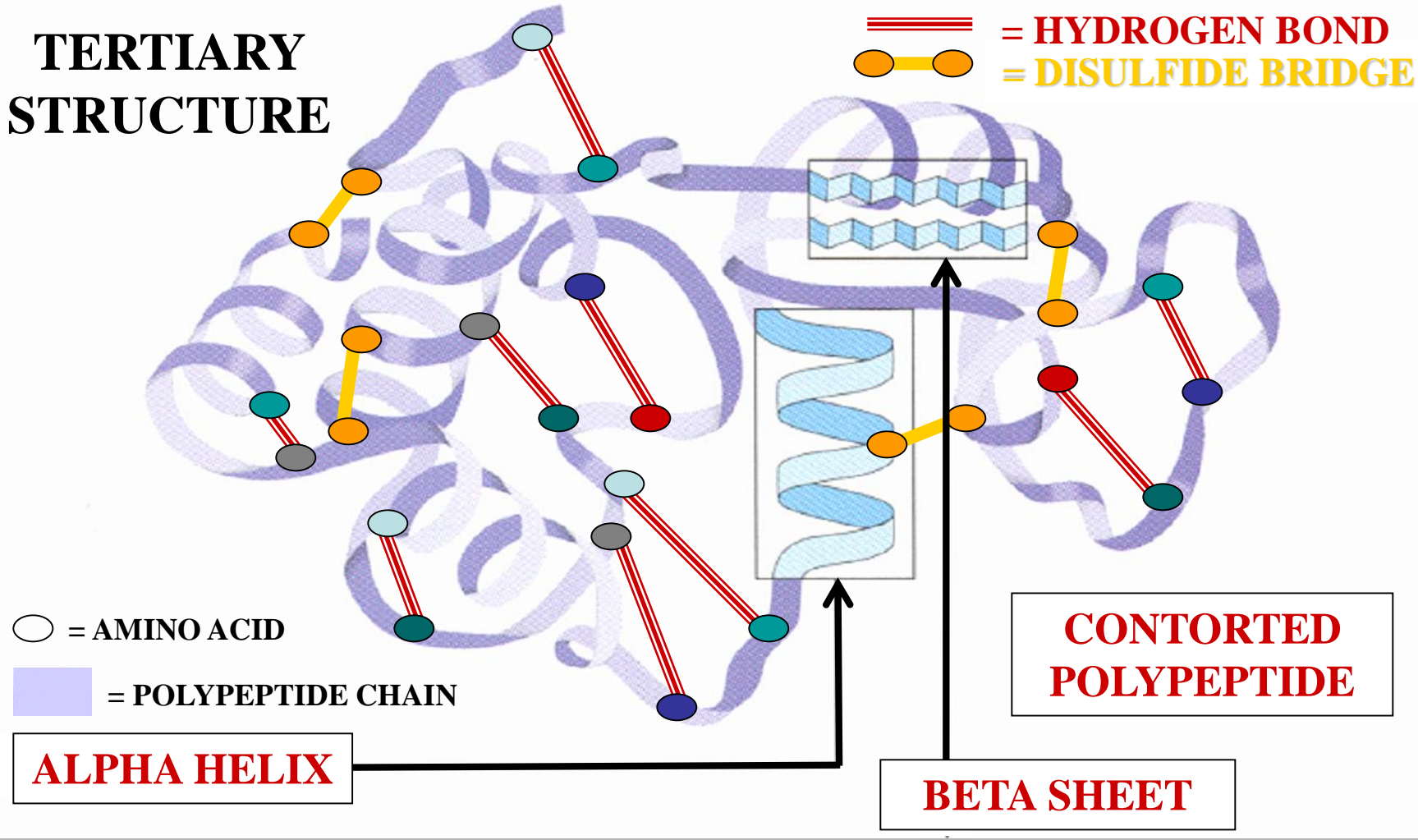

# TERTIARY STRUCTURE

**DISULFIDE  
BRIDGES**





# TERTIARY STRUCTURE

**DISULFIDE  
BRIDGE**



**DISULFIDE BRIDGE**

**COVALENT BOND**

**DISULFIDE BRIDGE**



**DISULFIDE BRIDGE**

**COVALENT BOND**

**---**

**BETWEEN TWO**

**CYSTEINE AMINO ACID**

**SULFUR ATOMS**

**DISULFIDE BRIDGE**

# PROTEIN STRUCTURE

## TERTIARY STRUCTURE

