

PHOSPHODIESTER BOND



PHOSPHODIESTER BOND

COVALENT BOND

PHOSPHODIESTER BOND



PHOSPHODIESTER BOND

COVALENT BOND

FORMED VIA

PHOSPHATE & SUGAR

INTERACTION

PHOSPHODIESTER BOND

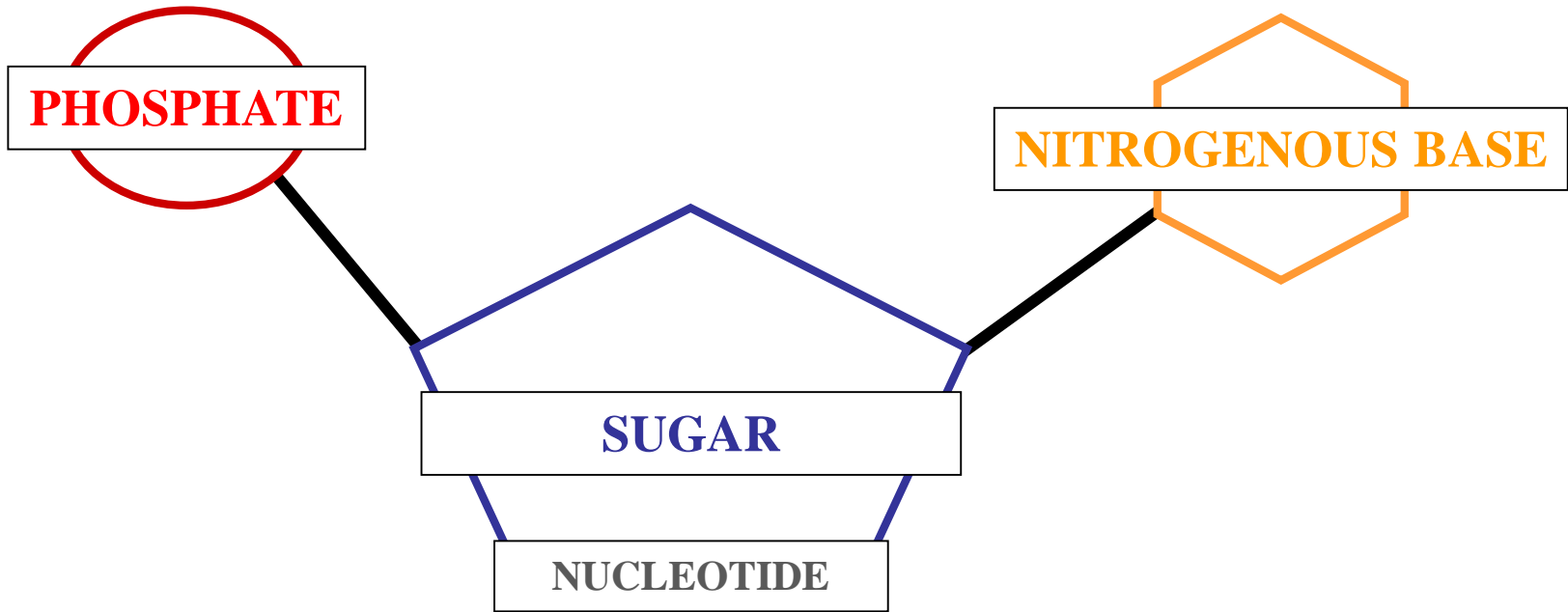

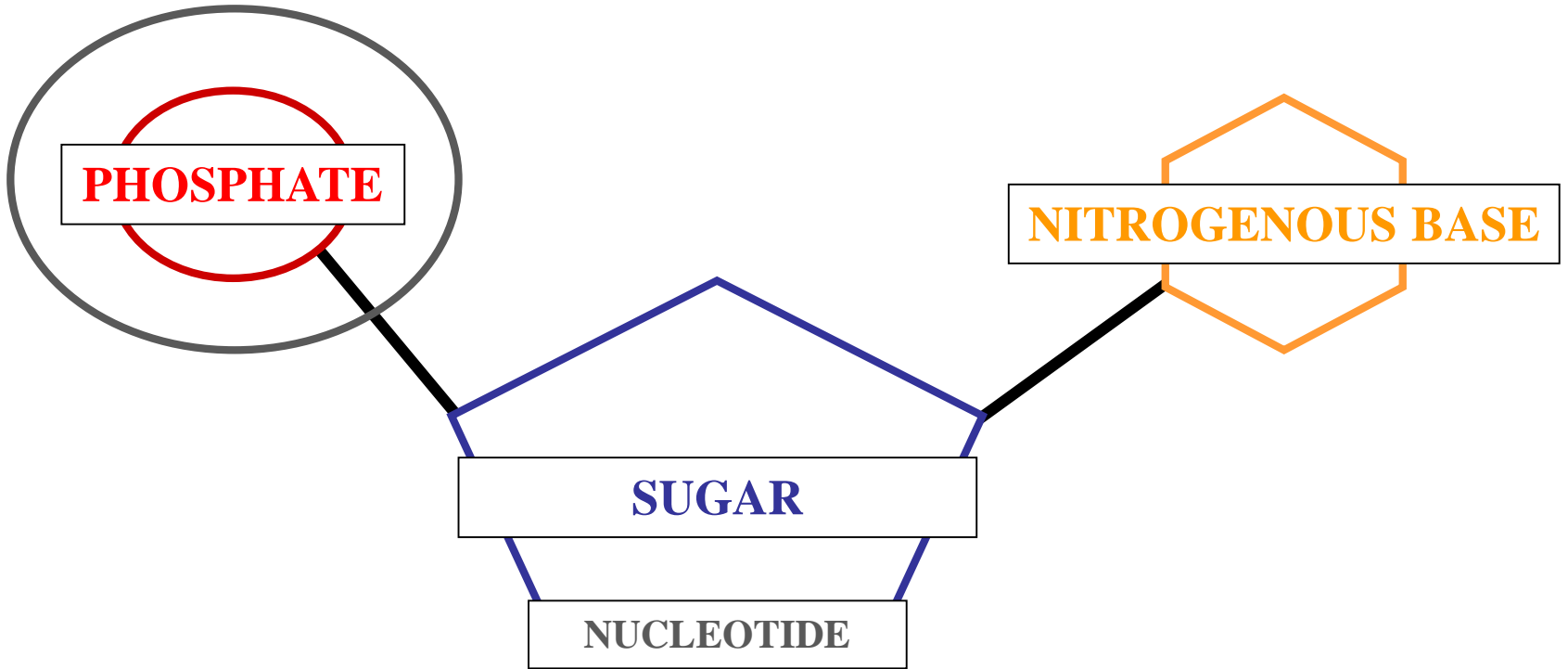

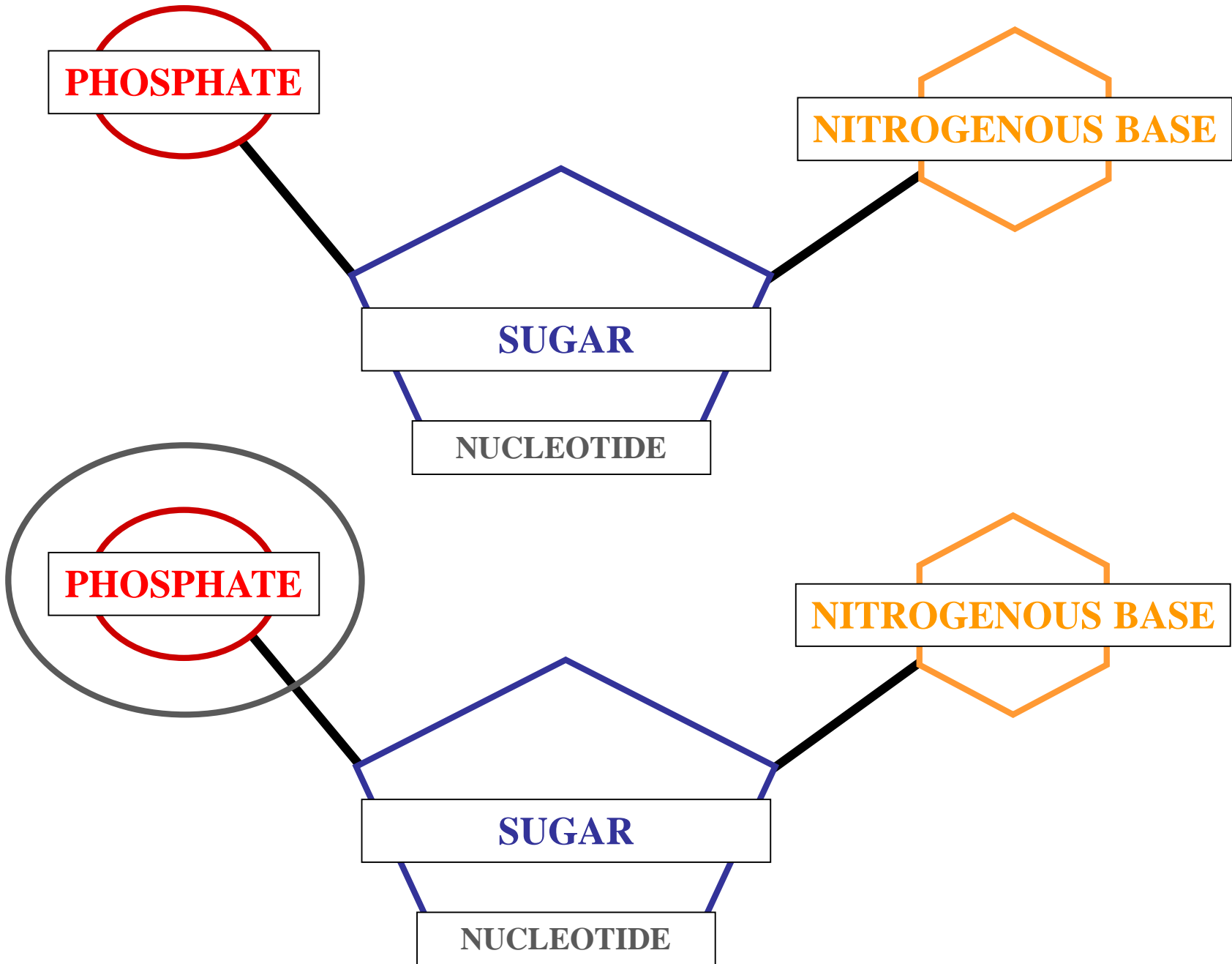

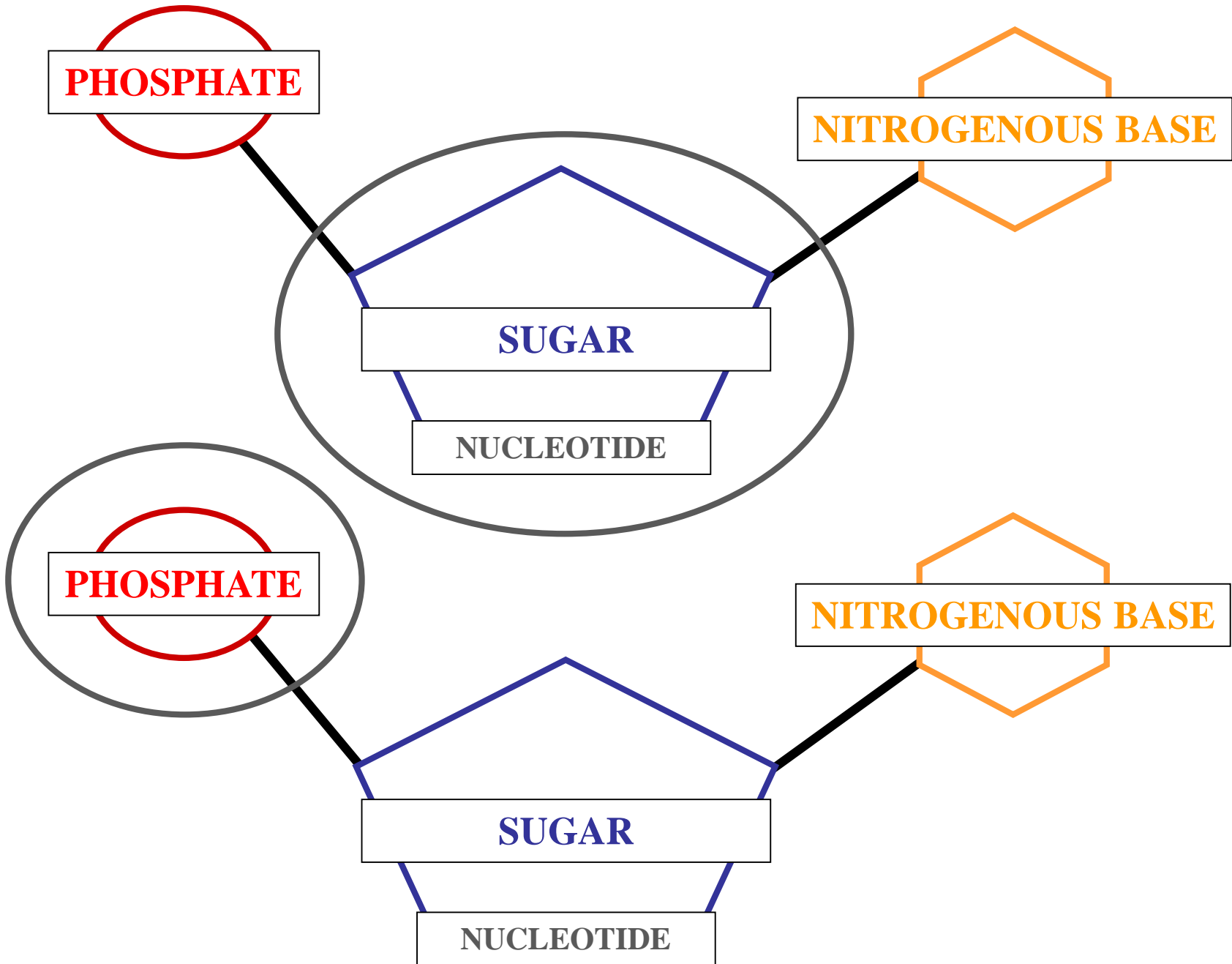

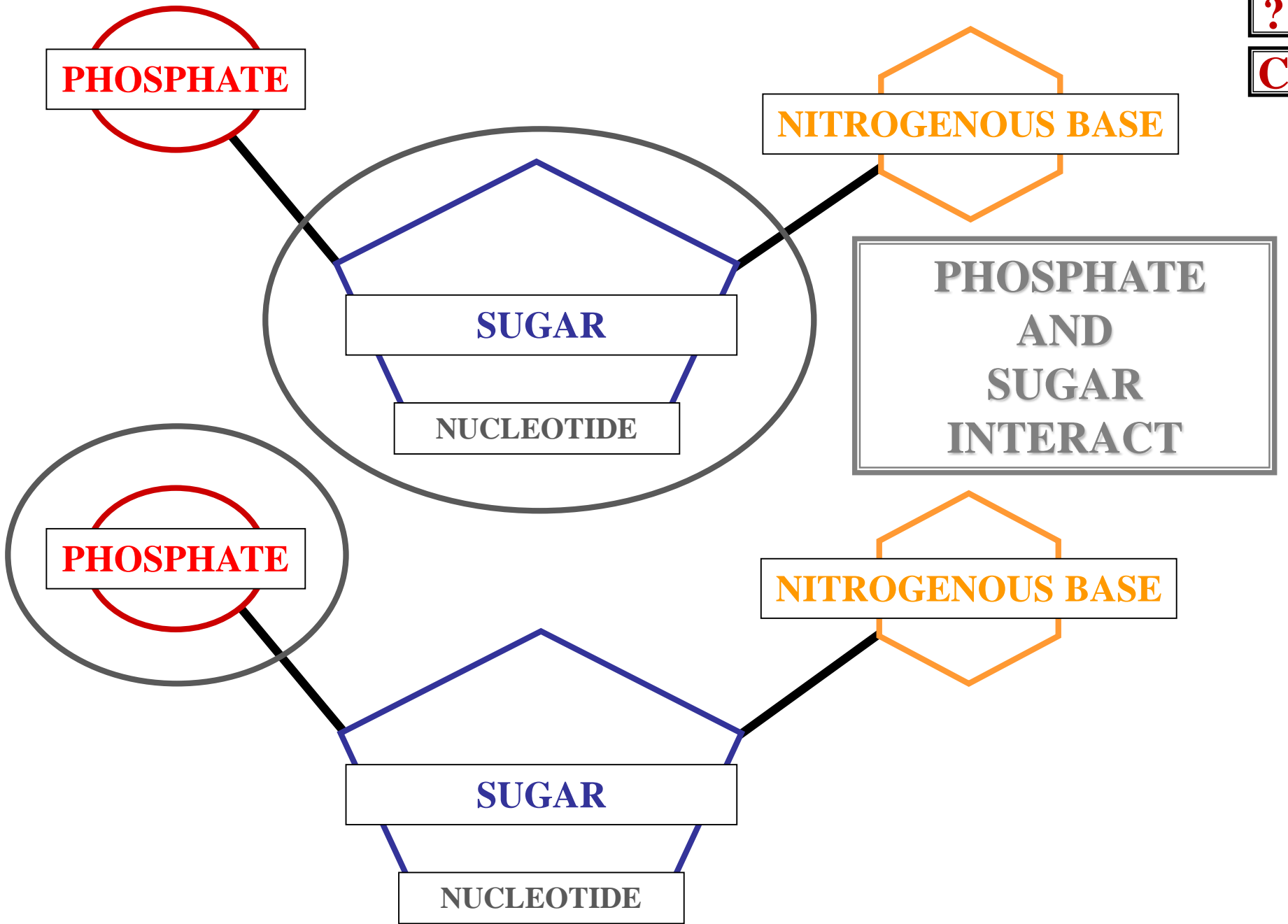

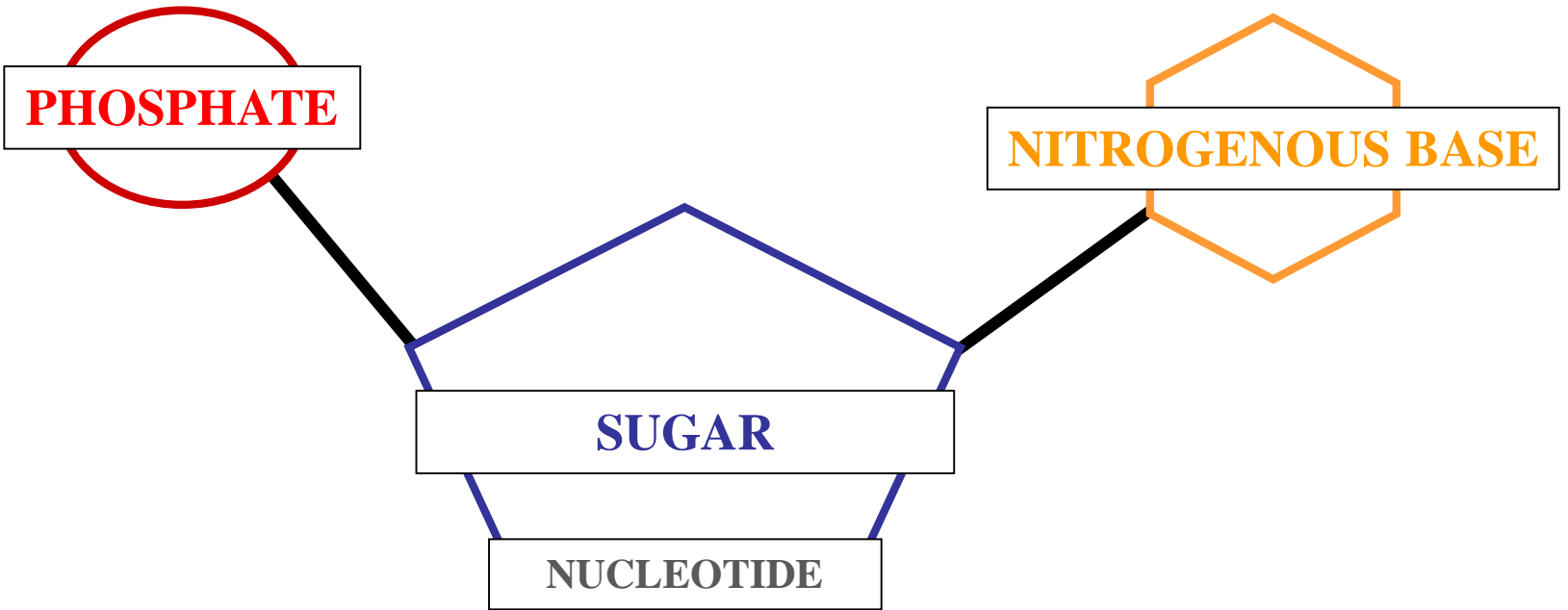
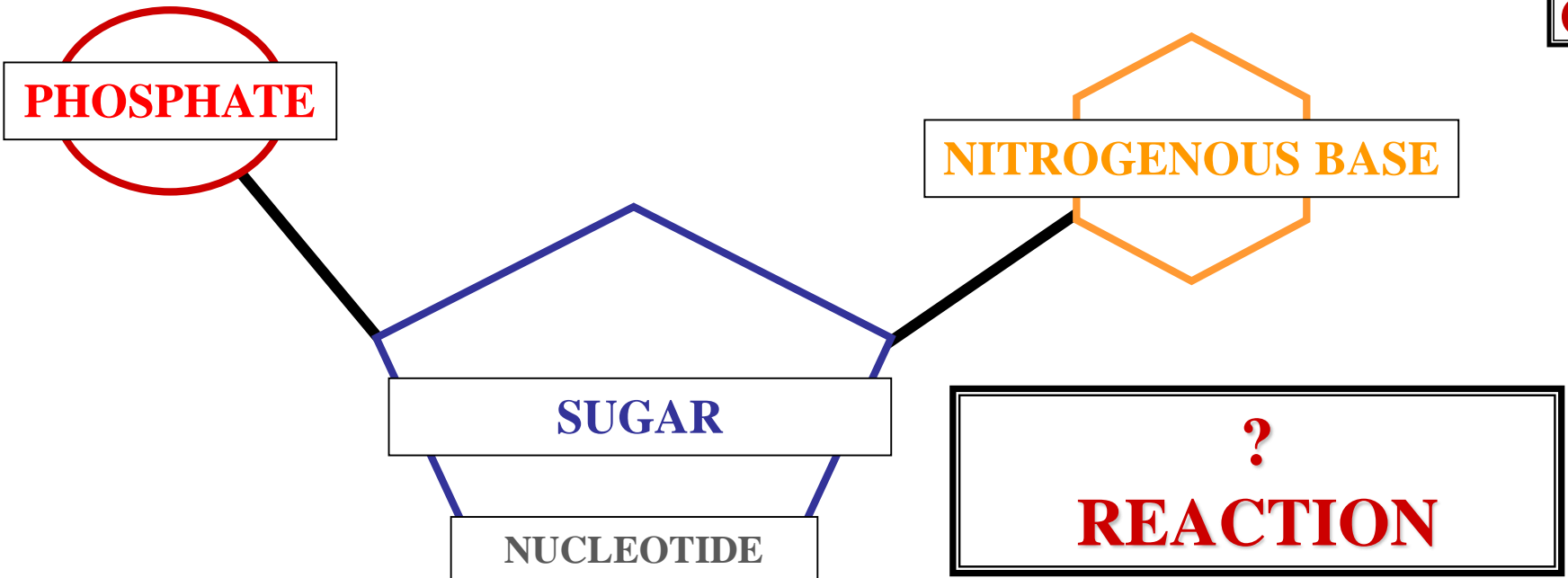

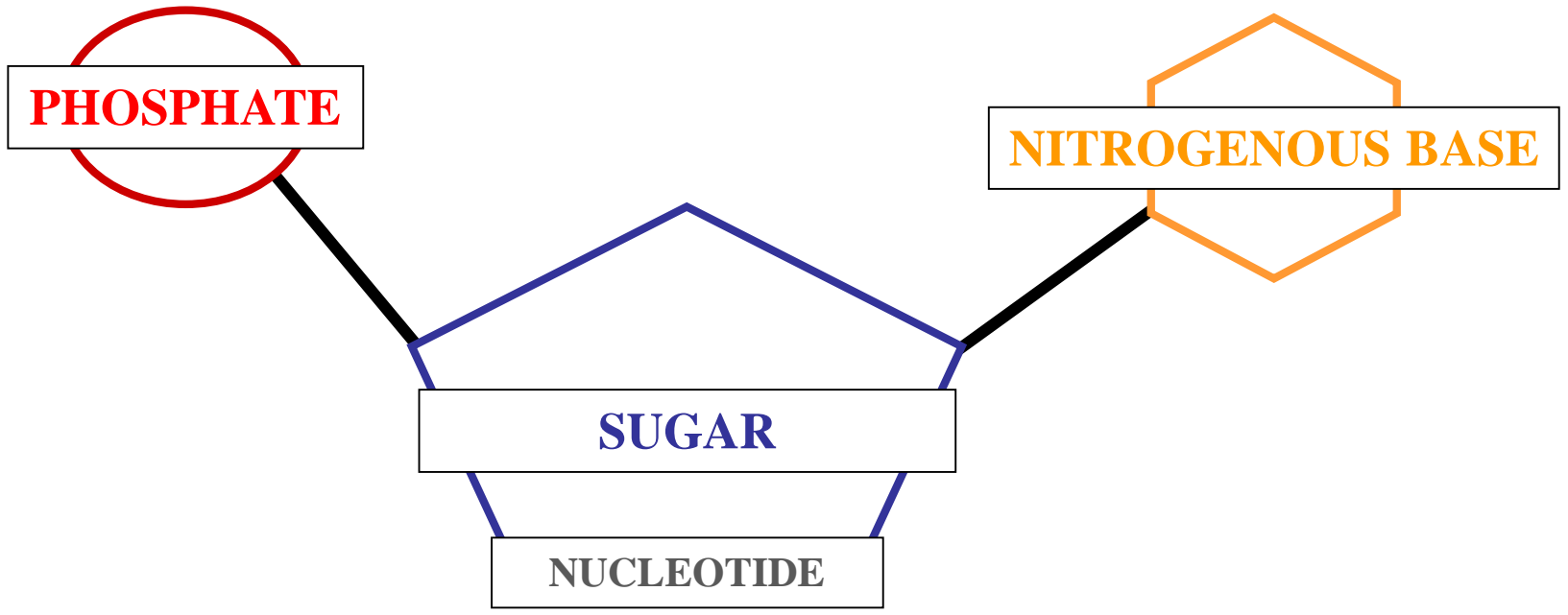
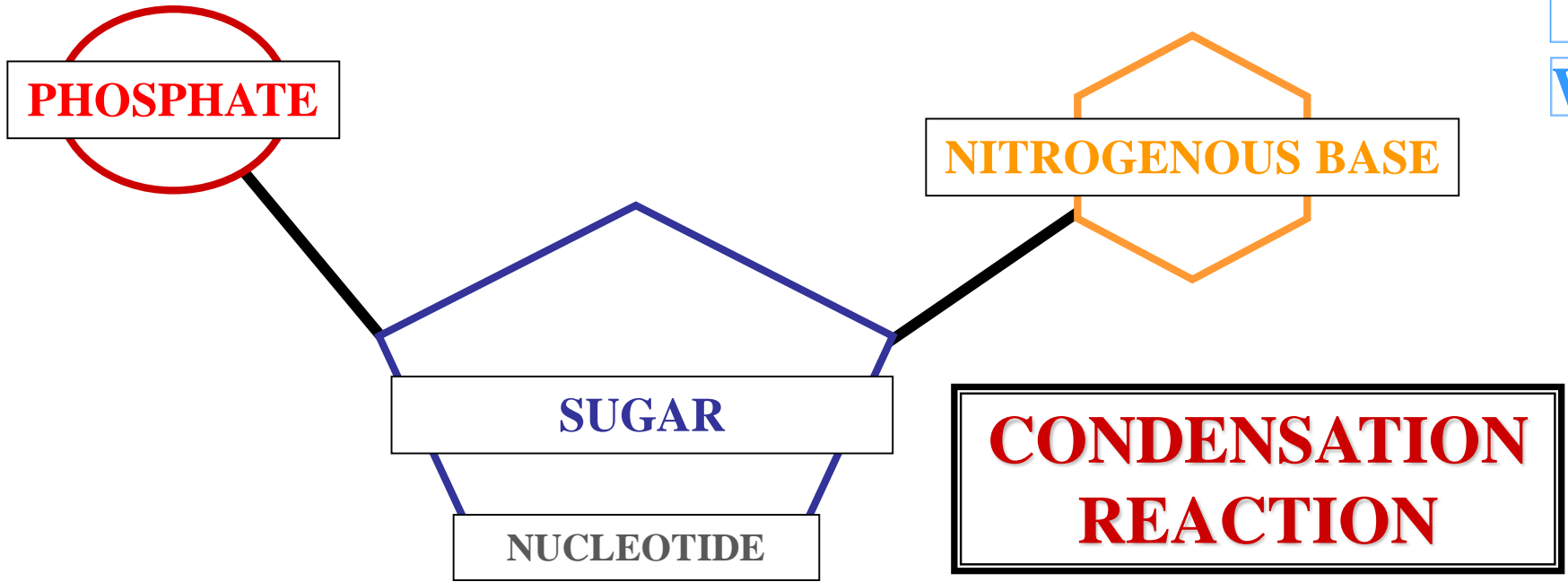

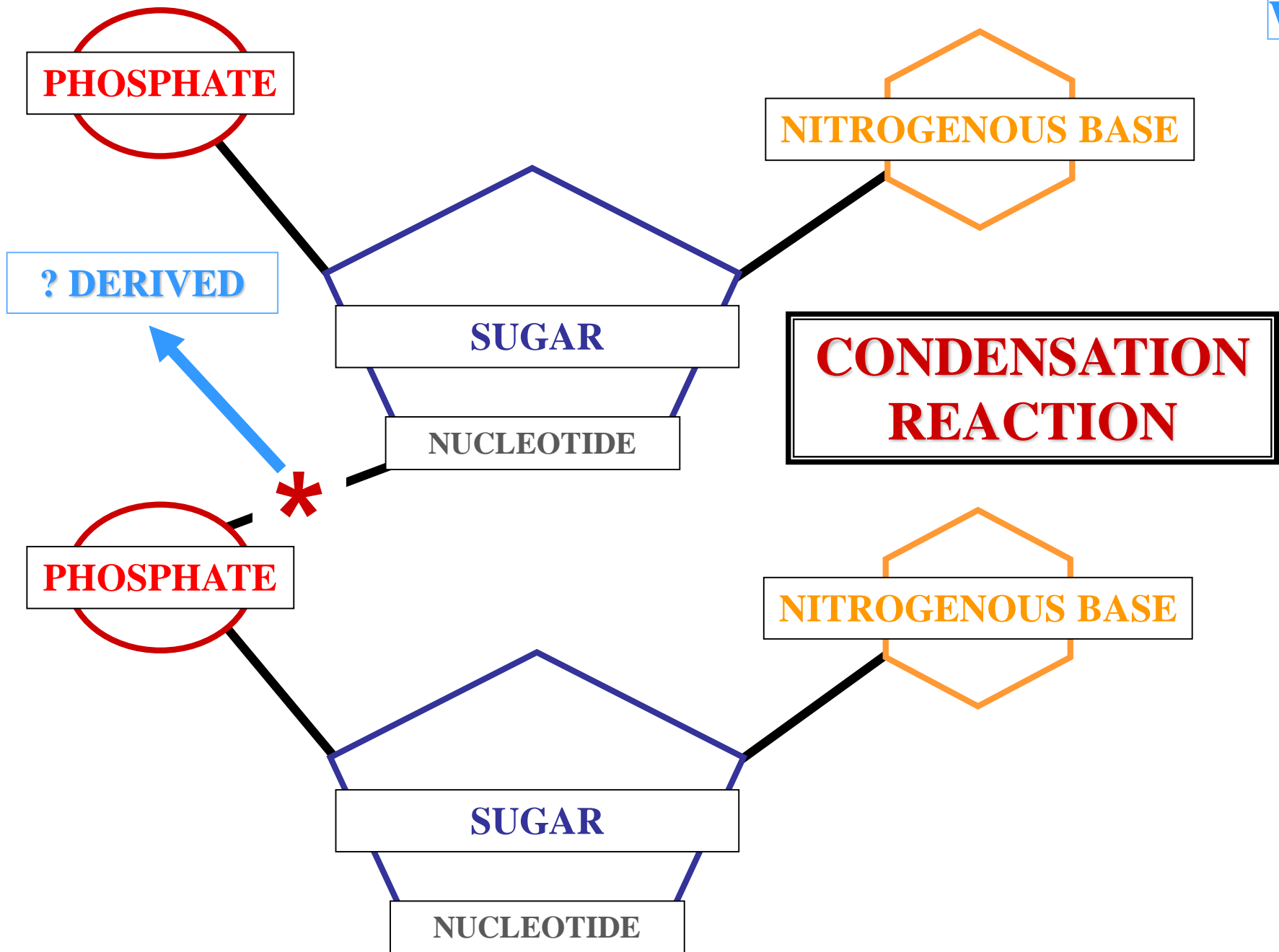

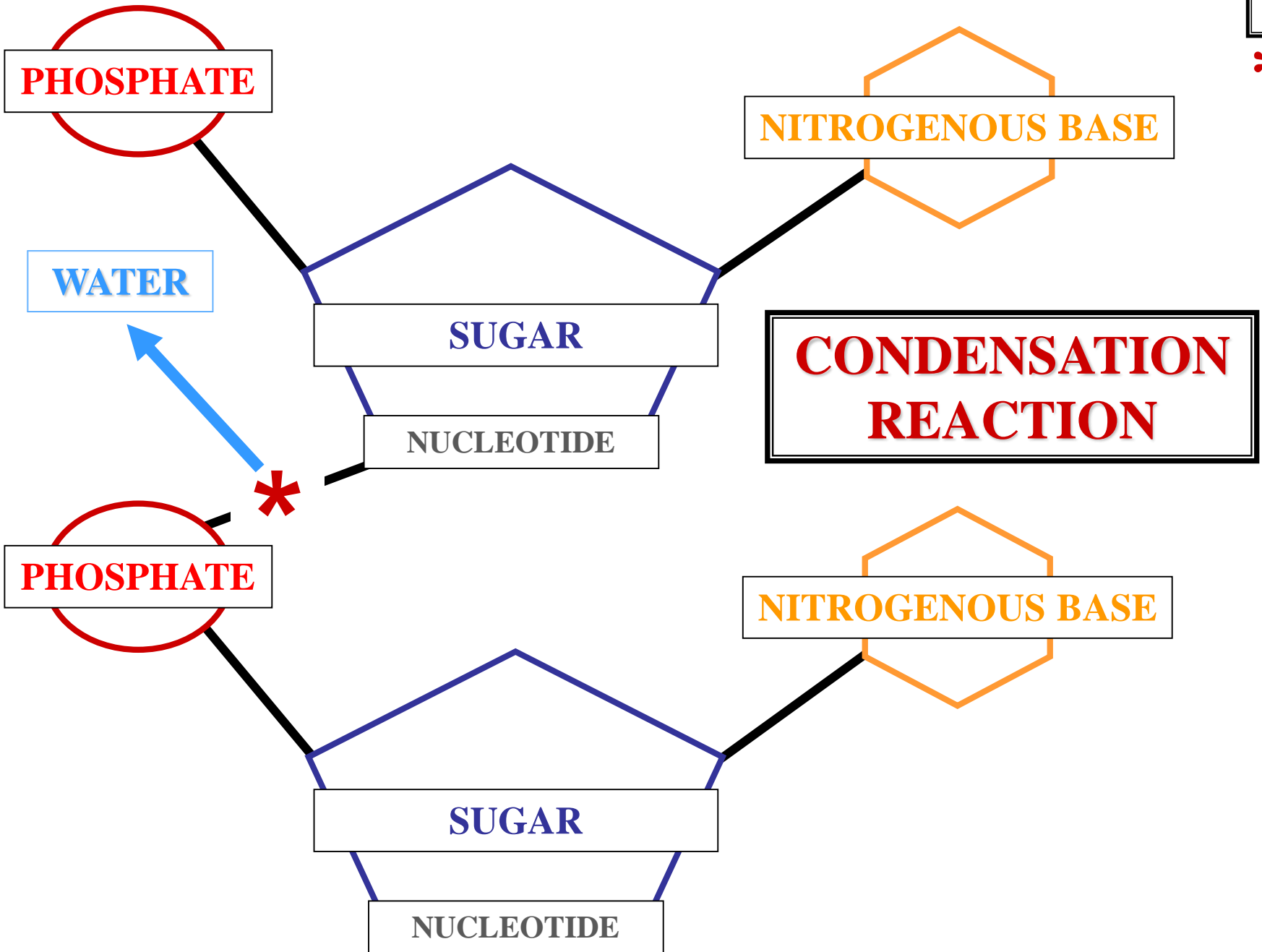

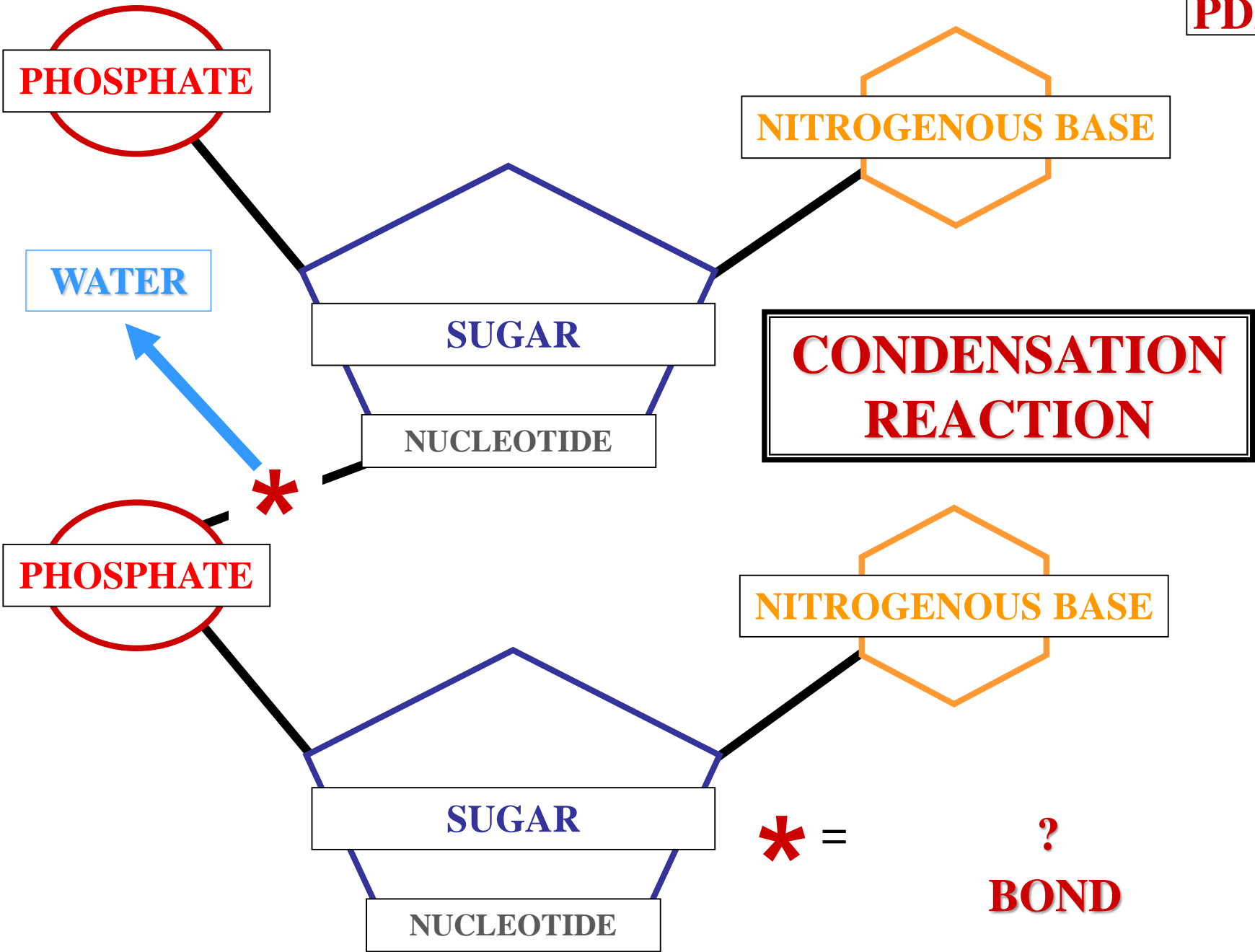

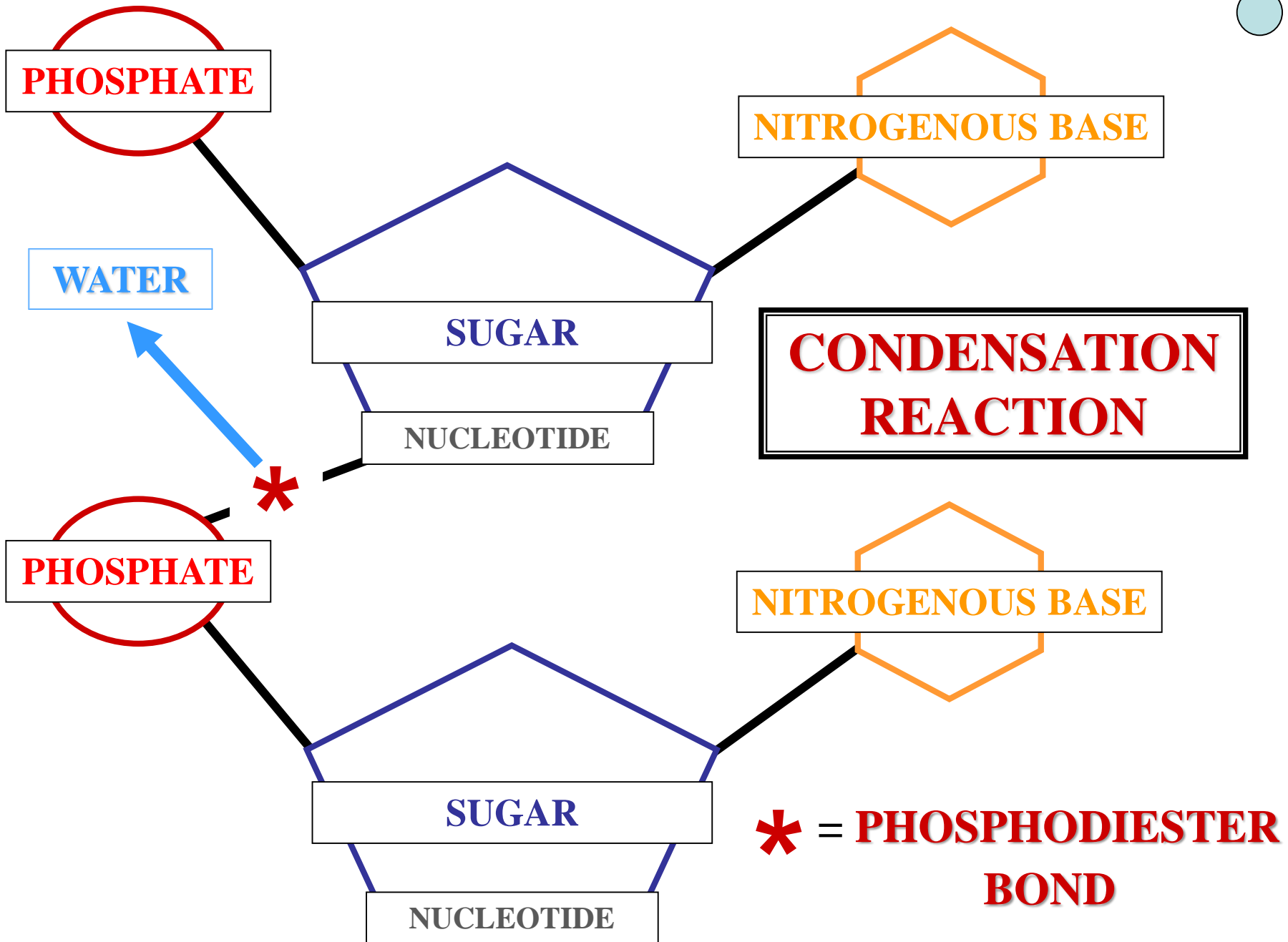



NUCLEIC ACID STRUCTURE



NUCLEOTIDE

NUCLEIC ACID STRUCTURE

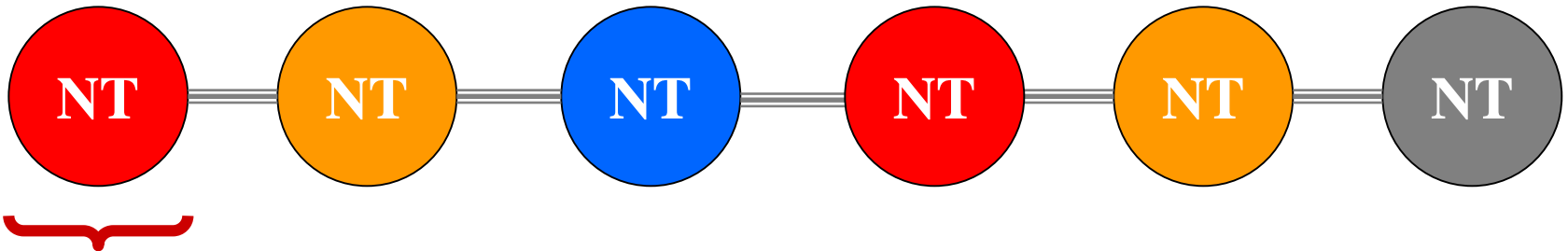

NUCLEOTIDE \equiv = BOND ?



NUCLEIC ACID STRUCTURE

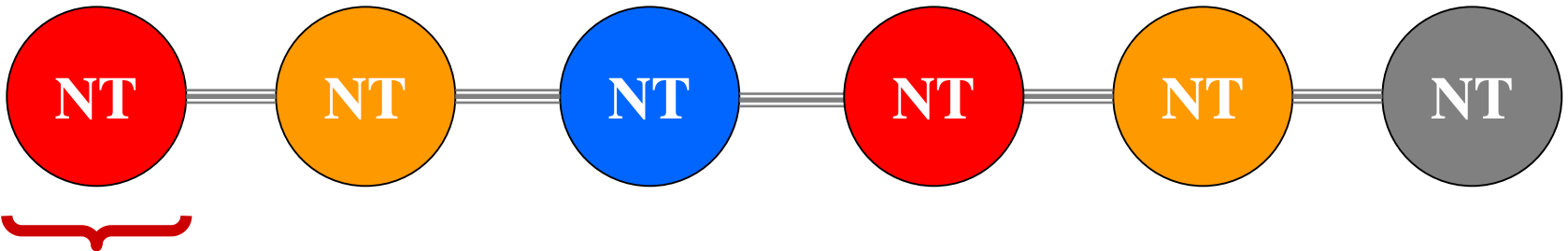

NUCLEOTIDE == = PHOSPHODIESTER BOND

NUCLEIC ACID STRUCTURE

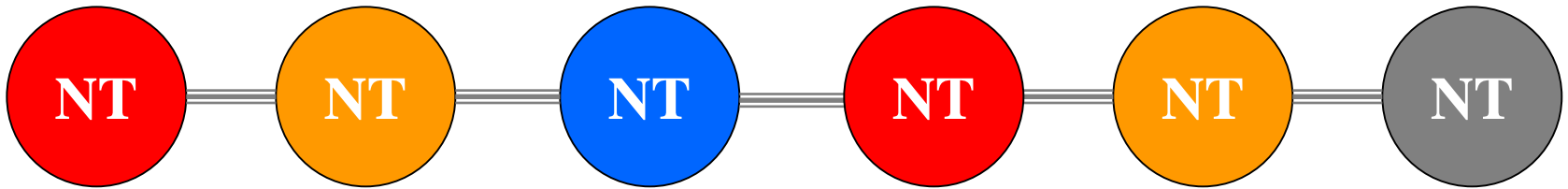

NUCLEOTIDE \equiv = PHOSPHODIESTER BOND

?

NUCLEIC ACID STRUCTURE

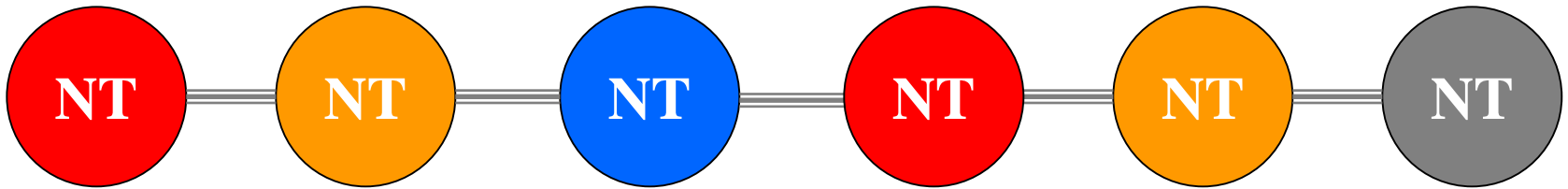

NUCLEOTIDE == = PHOSPHODIESTER BOND

POLYNUCLEOTIDE

POLYNUCLEOTIDE



POLYNUCLEOTIDE

**MANY BONDED
NUCLEOTIDES**

POLYNUCLEOTIDE

NUCLEIC ACID STRUCTURE

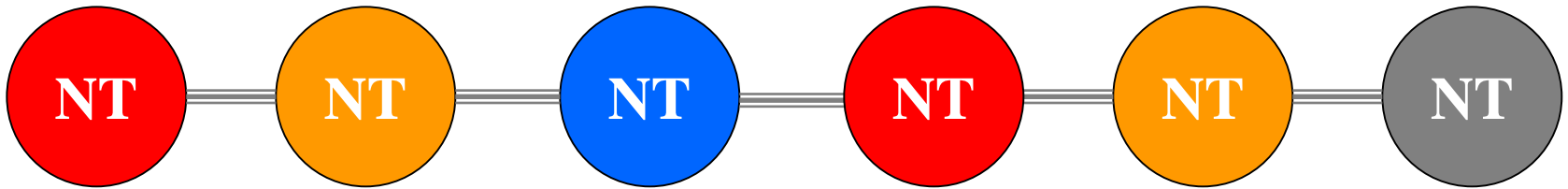

NUCLEOTIDE == = PHOSPHODIESTER BOND

POLYNUCLEOTIDE

NUCLEIC ACID STRUCTURE

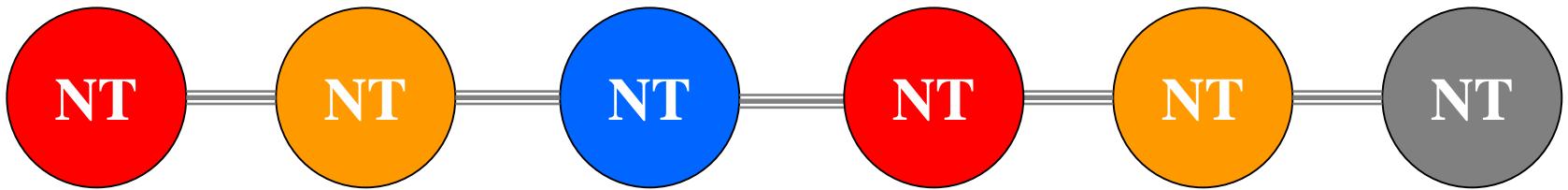

NUCLEOTIDE == = **PHOSPHODIESTER BOND**

POLYNUCLEOTIDE = NUCLEIC ACID

POLYNUCLEOTIDE

SYNONYMOUS

NUCLEIC ACID



NUCLEIC ACID TYPES

NUCLEIC ACIDS

L D

?

?

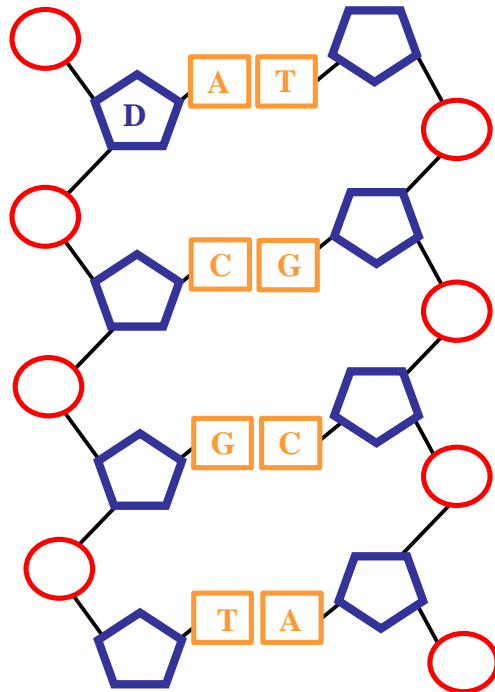

NUCLEIC ACID

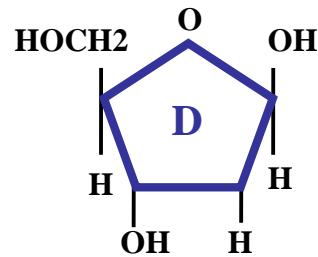

DEOXYRIBOSE

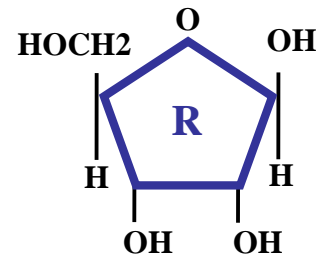

RIBOSE

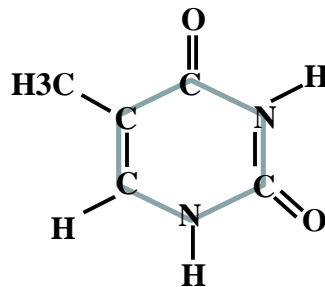

THYMINE

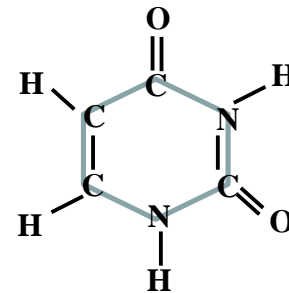

URACIL

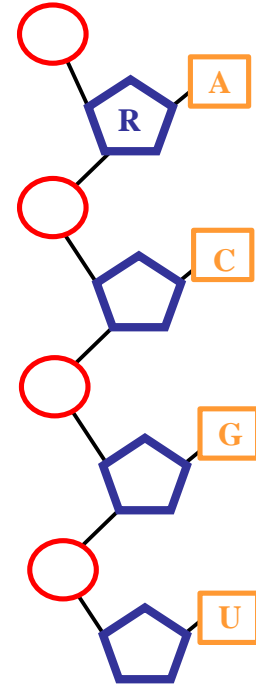

NUCLEIC ACID

NUCLEIC ACIDS

R

DNA

?

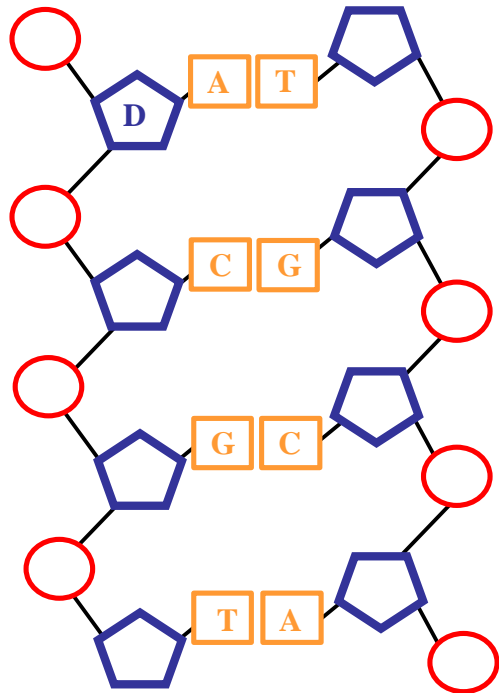

NUCLEIC ACID

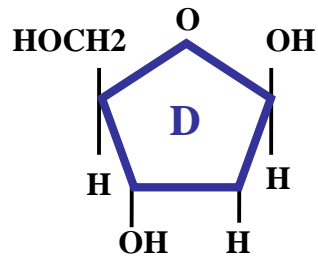

DEOXYRIBOSE

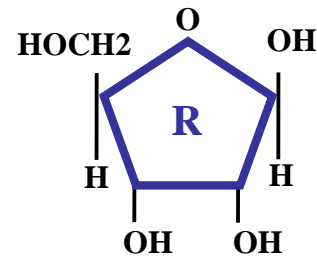

RIBOSE

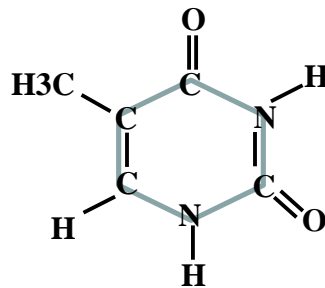

THYMINE

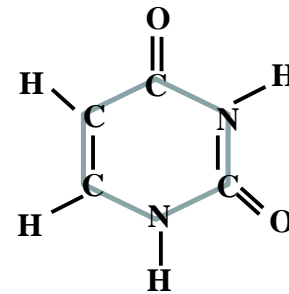

URACIL

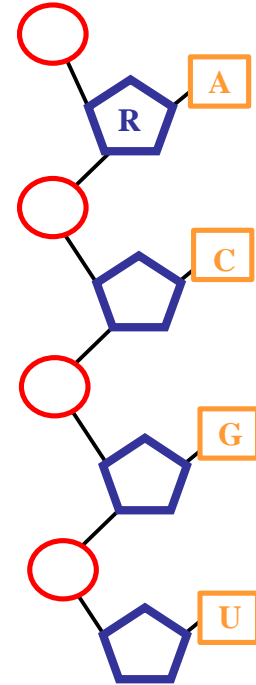

NUCLEIC ACID

NUCLEIC ACIDS

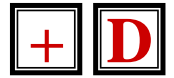

DNA

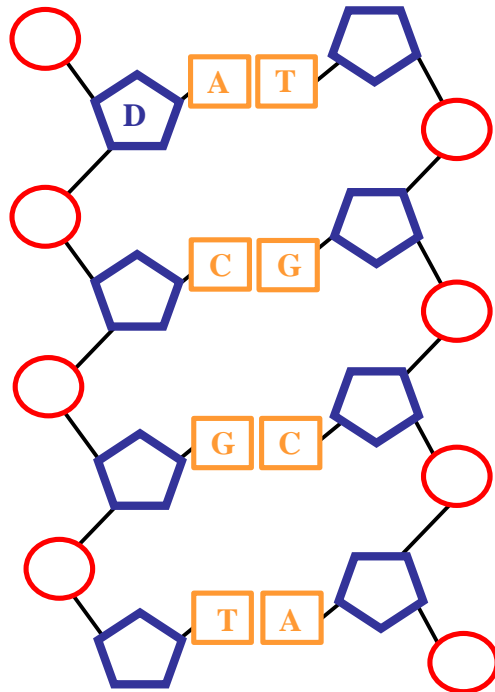

NUCLEIC ACID

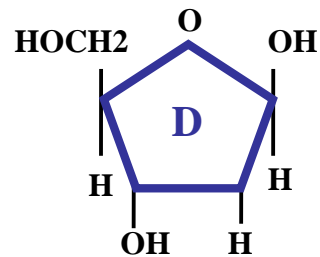

DEOXYRIBOSE

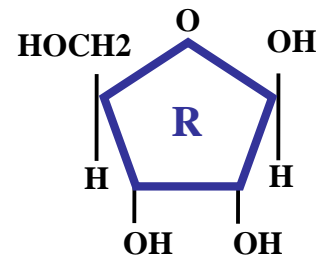

RIBOSE

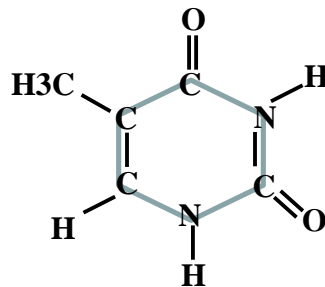

THYMINE

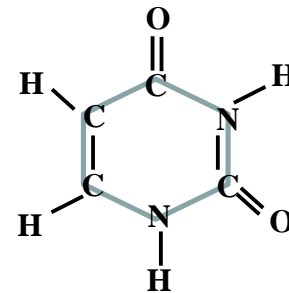

URACIL

RNA

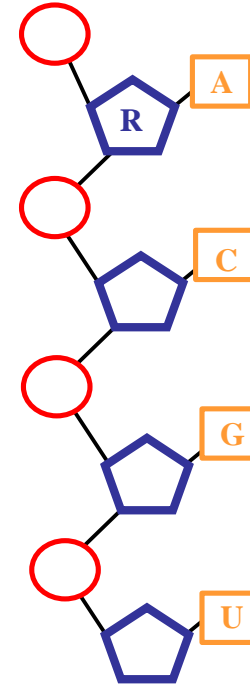

NUCLEIC ACID

NUCLEIC ACIDS

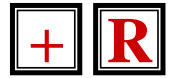

DEOXYRIBONUCLEIC ACID

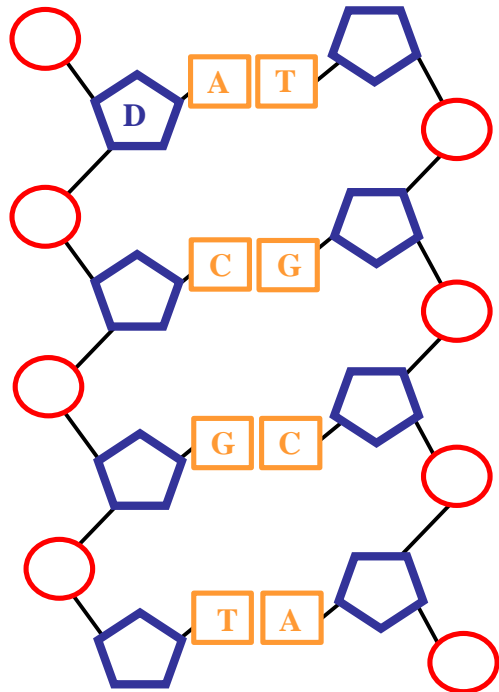

NUCLEIC ACID

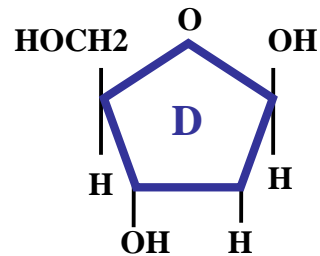

DEOXYRIBOSE

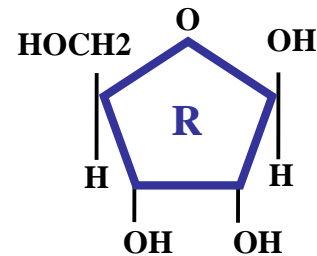

RIBOSE

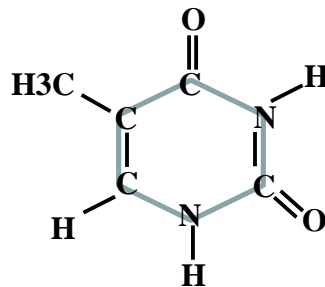

THYMINE

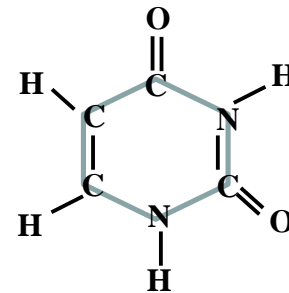

URACIL

RNA

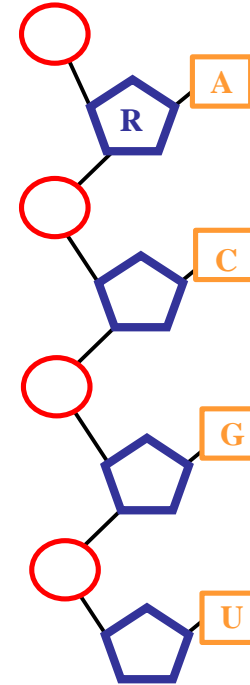

NUCLEIC ACID

NUCLEIC ACIDS



DNA

RIBONUCLEIC ACID

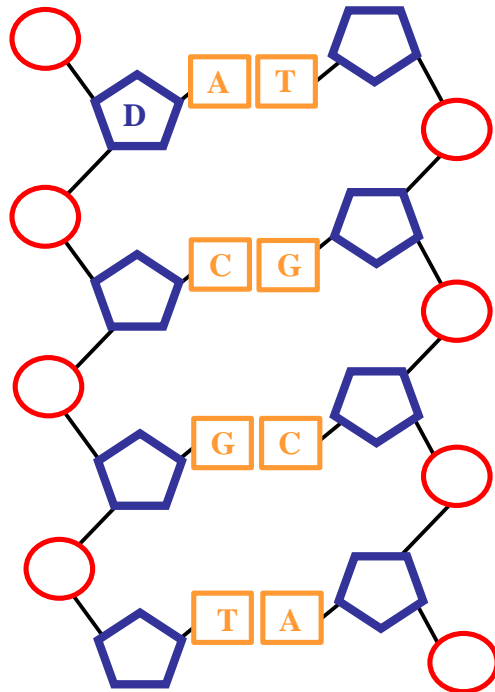

NUCLEIC ACID

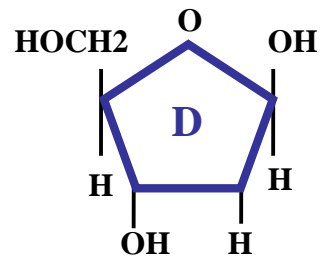

DEOXYRIBOSE

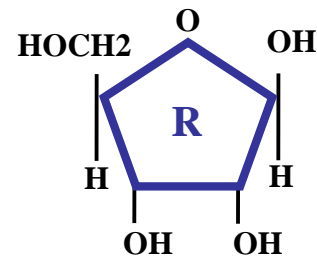

RIBOSE

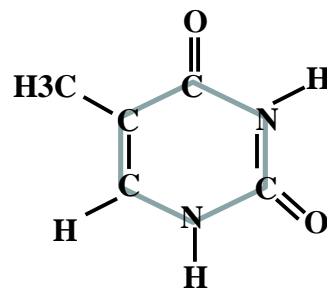

THYMINE

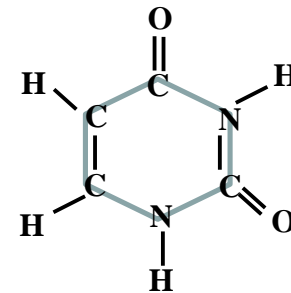

URACIL

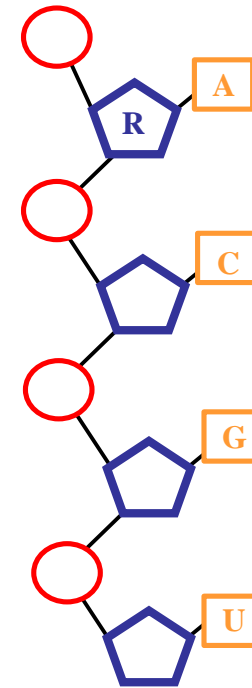

NUCLEIC ACID

NUCLEIC ACIDS

^

DNA

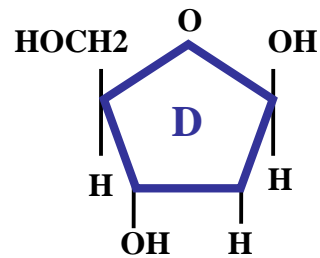
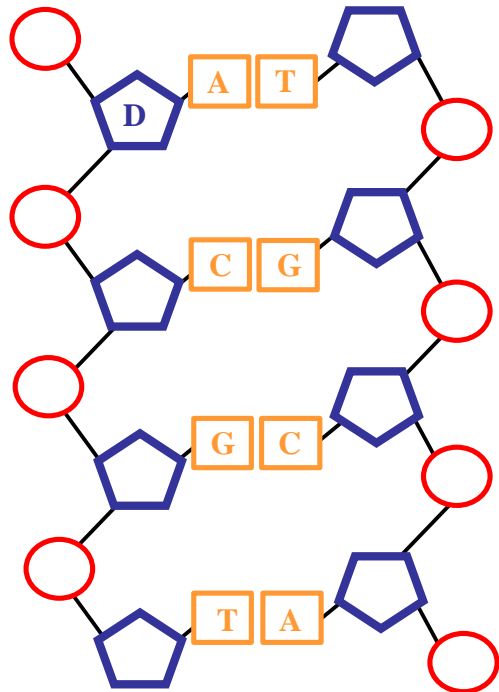

DEOXYRIBOSE

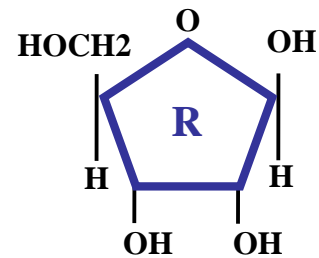

RIBOSE

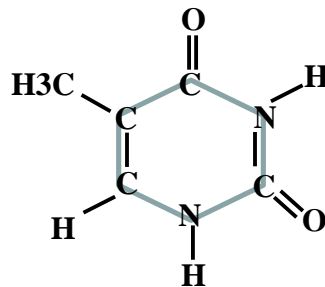

THYMINE

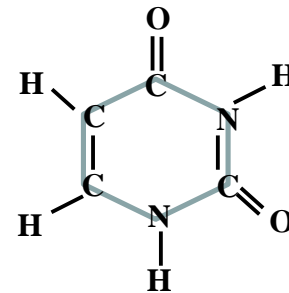

URACIL

RNA

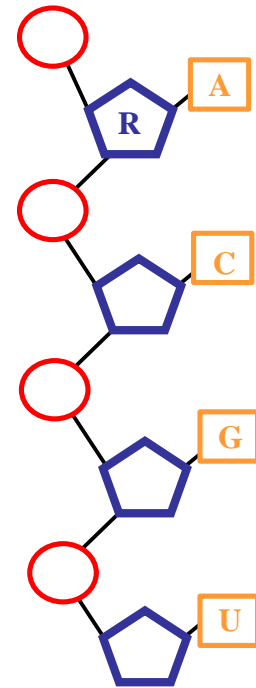

DNA
DEOXYRIBONUCLEIC
ACID

DNA

DEOXYRIBONUCLEIC

ACID

DNA

DEOXYRIBONUCLEIC ACID



**STORES GENETIC
INFORMATION**

DNA

DEOXYRIBONUCLEIC ACID

PROTEIN SYNTHESIS

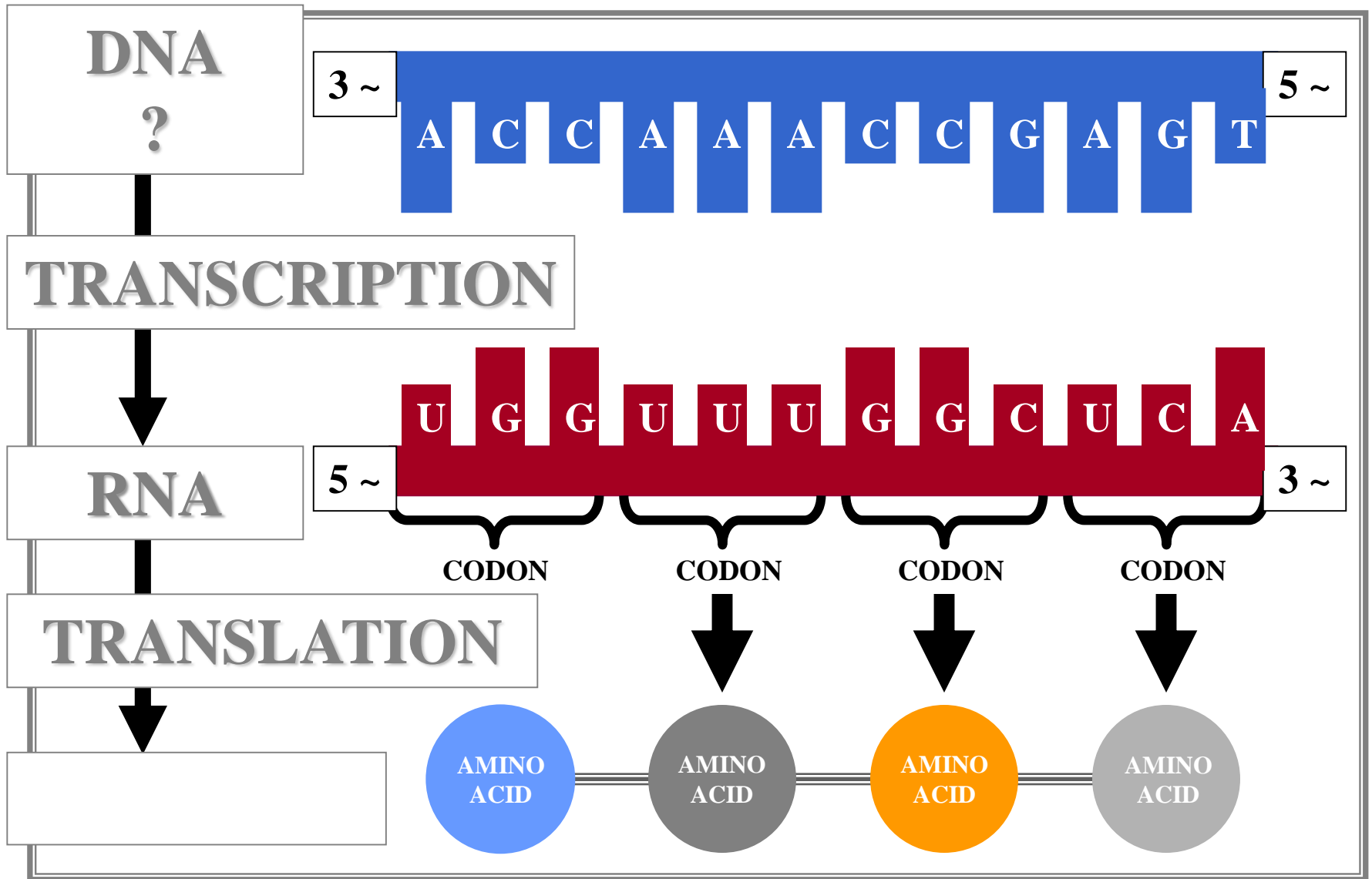

PROTEIN SYNTHESIS

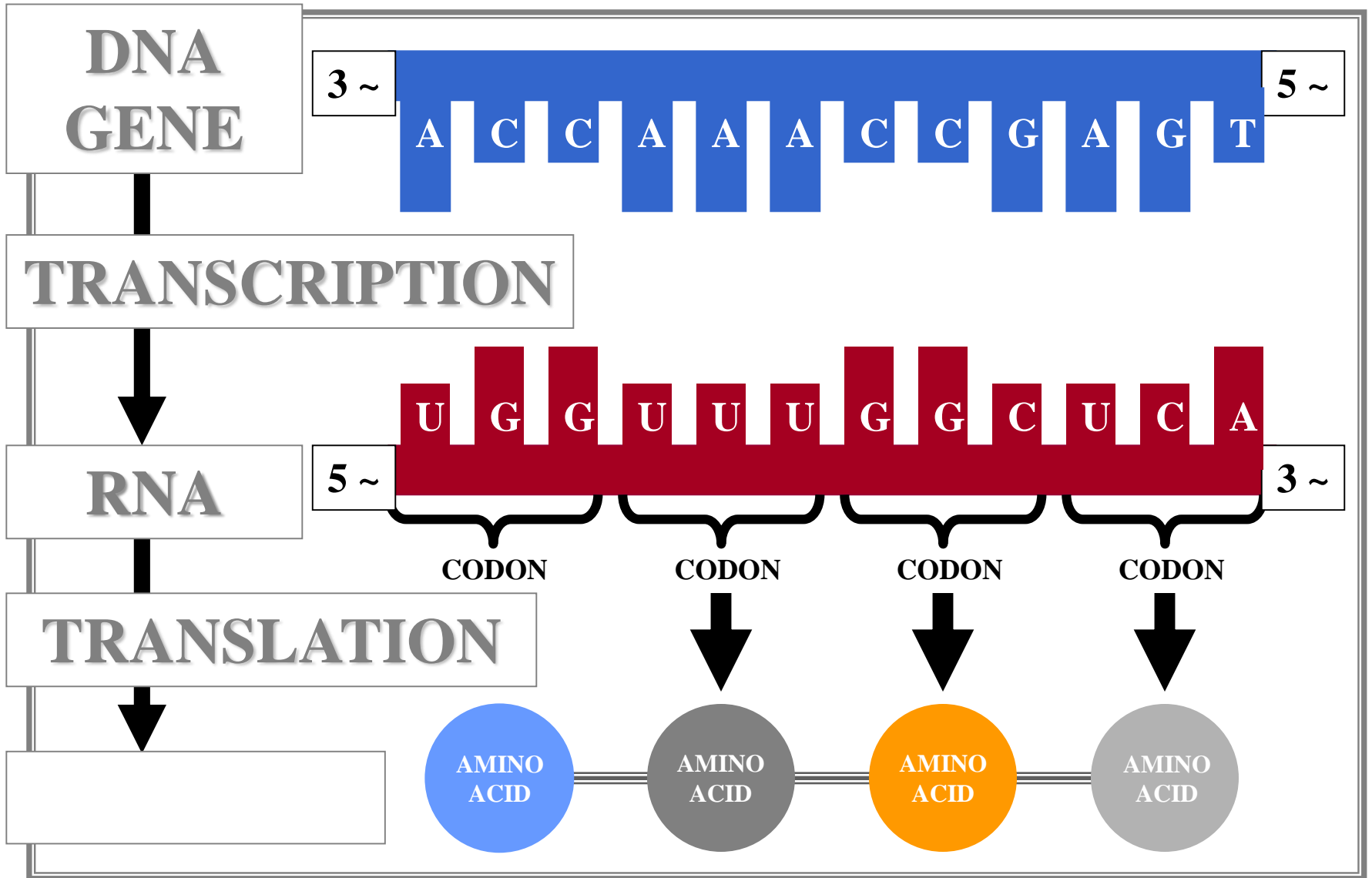
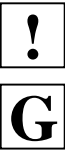

GENE



GENE

**FUNCTIONAL
DNA SEGMENT**

GENE

PROTEIN SYNTHESIS

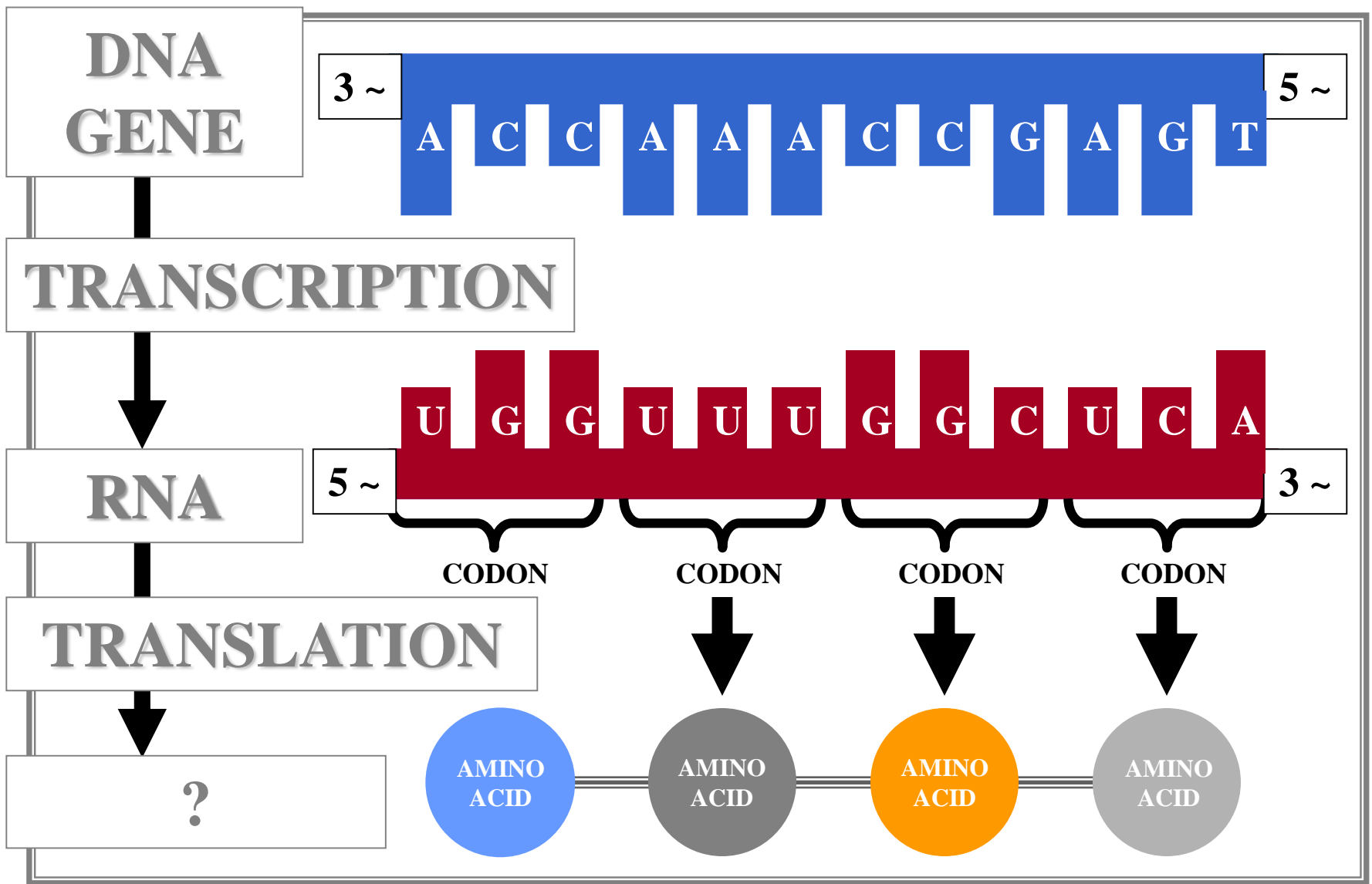

PROTEIN SYNTHESIS

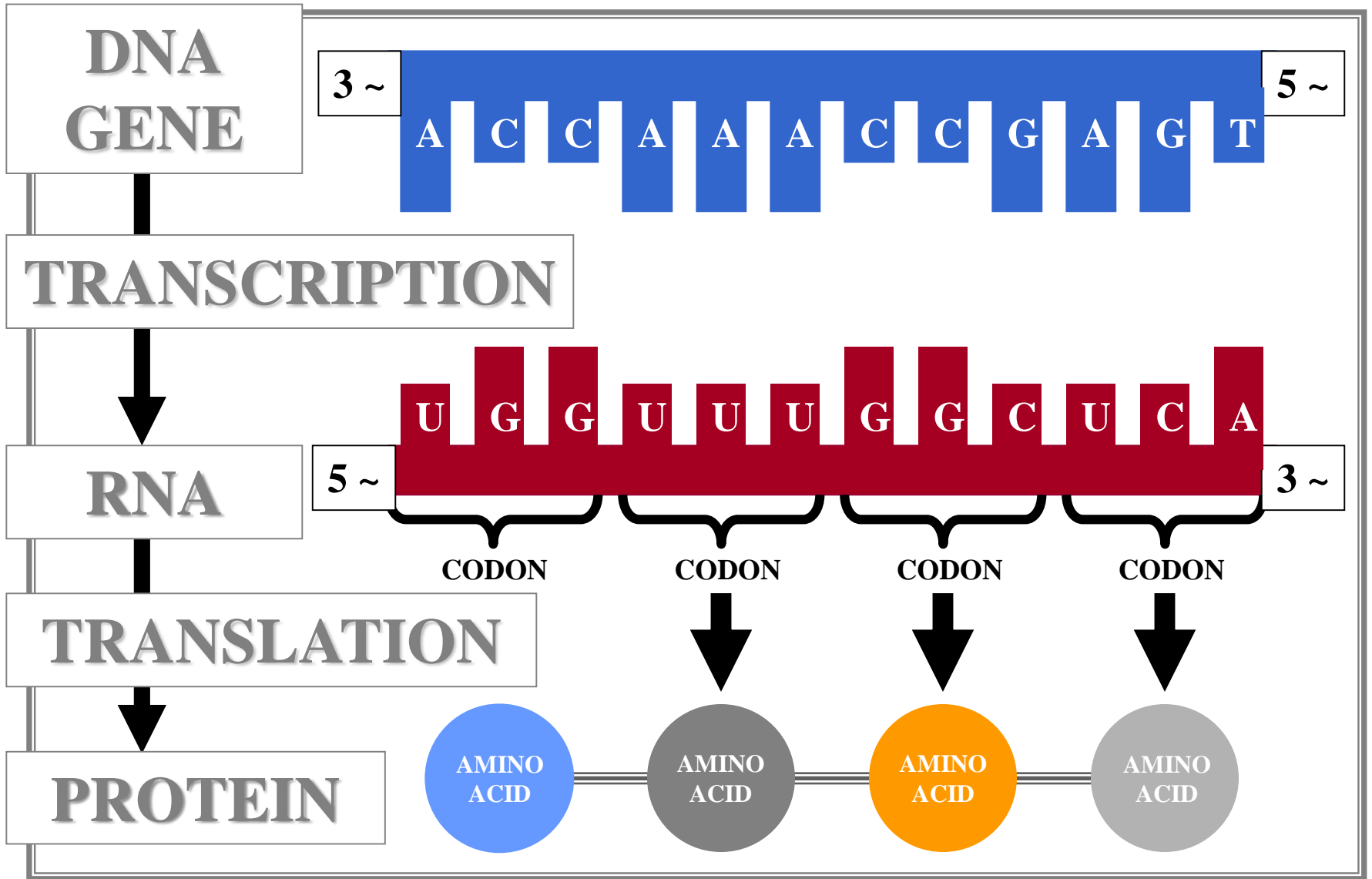

PROTEIN SYNTHESIS

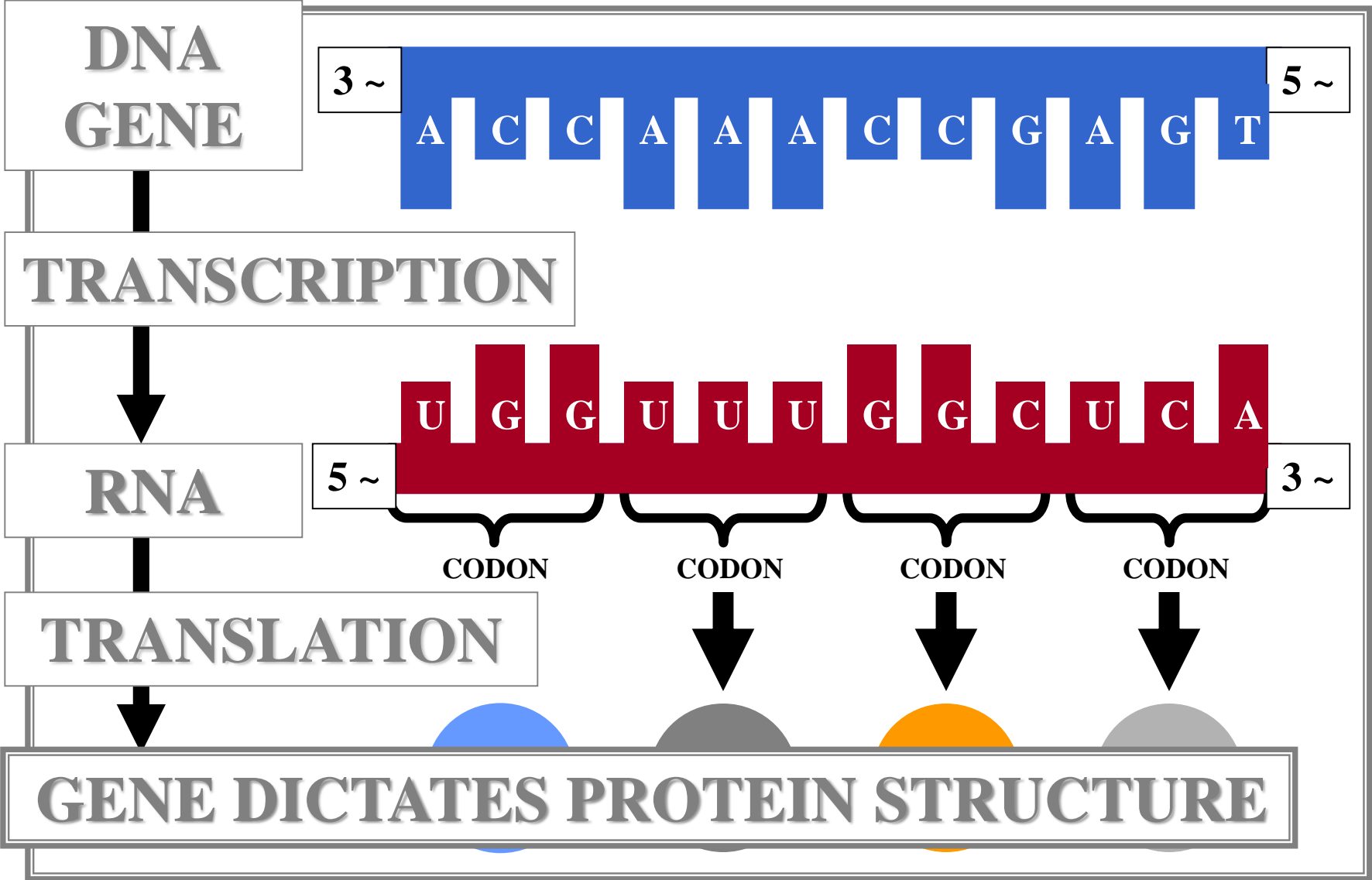

PROTEIN SYNTHESIS

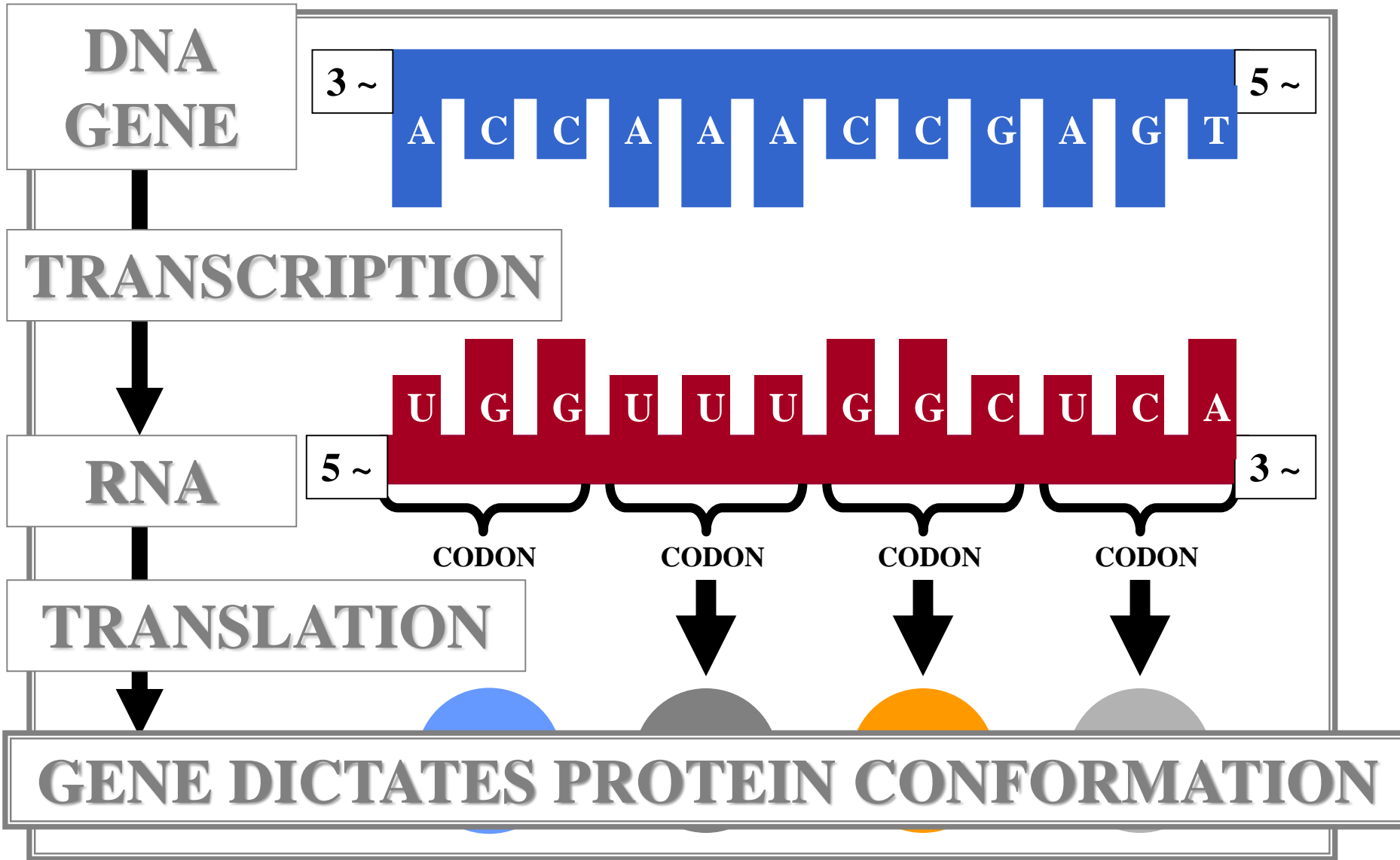

PROTEIN SYNTHESIS

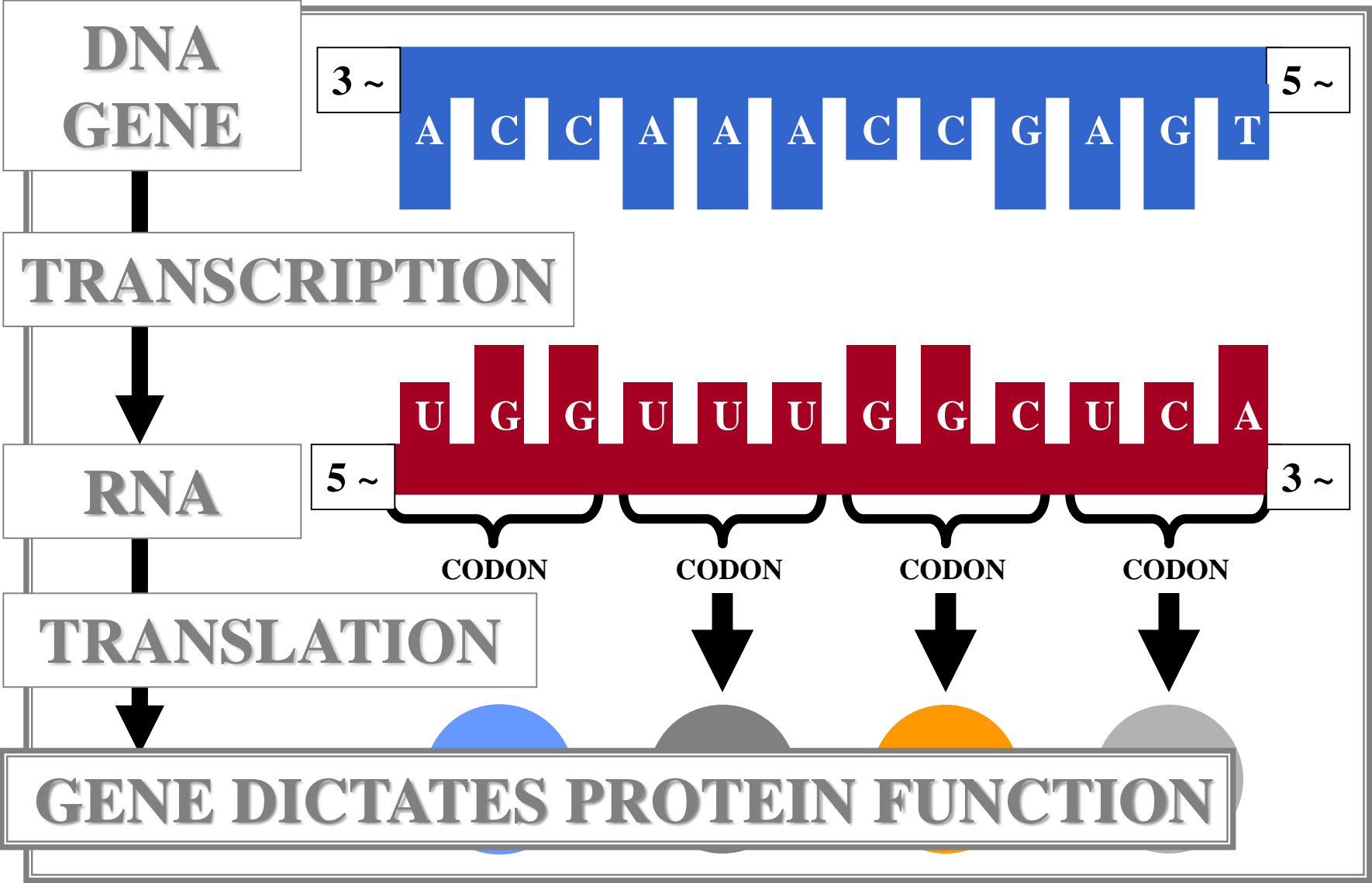

RNA
RIBONUCLEIC
ACID

RNA
RIBONUCLEIC
ACID

RNA **RIBONUCLEIC ACID**

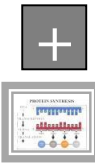

**TRANSLATES GENETIC
INFORMATION**

RNA
RIBONUCLEIC ACID

PROTEIN SYNTHESIS

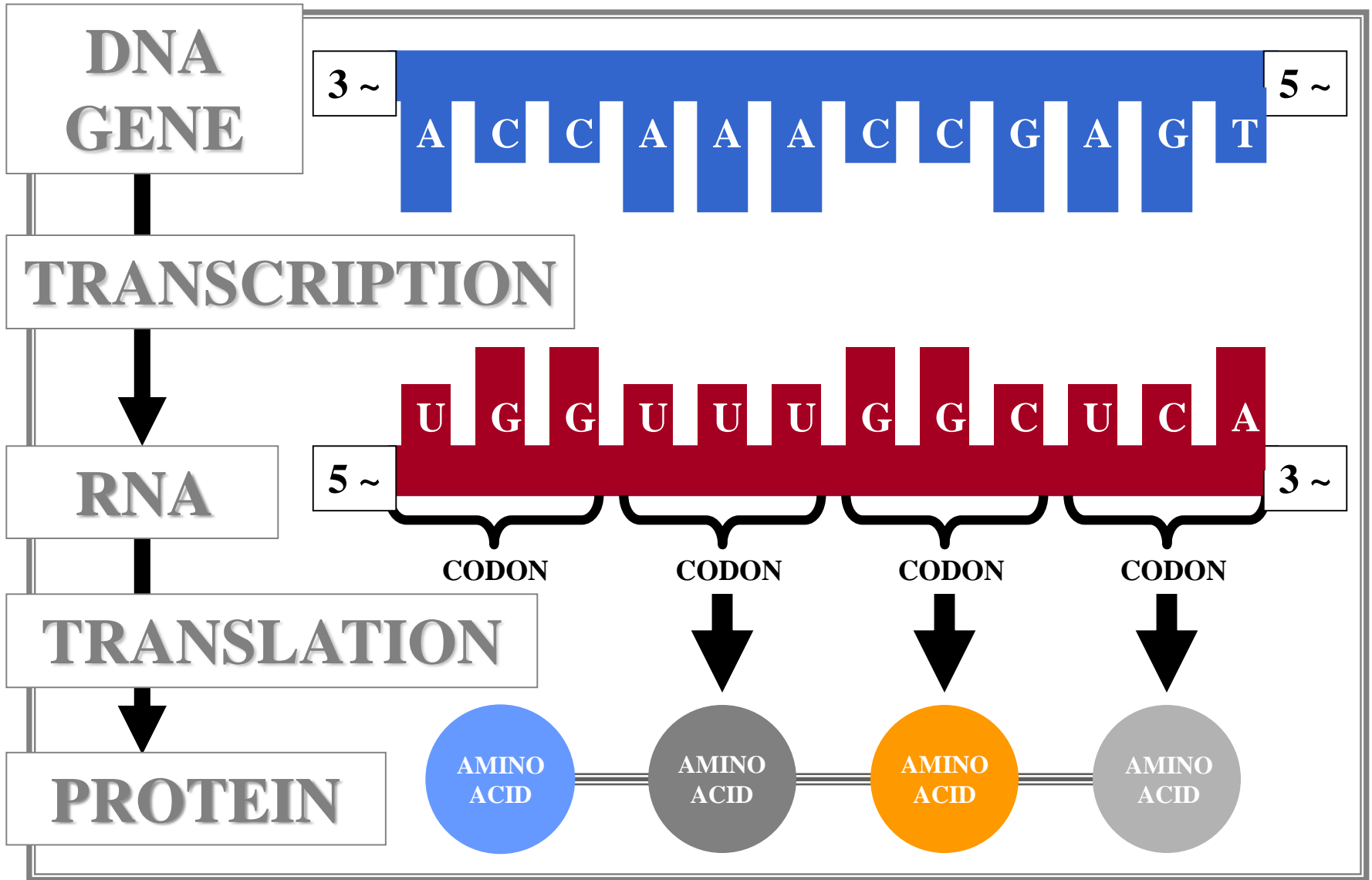

PROTEIN SYNTHESIS

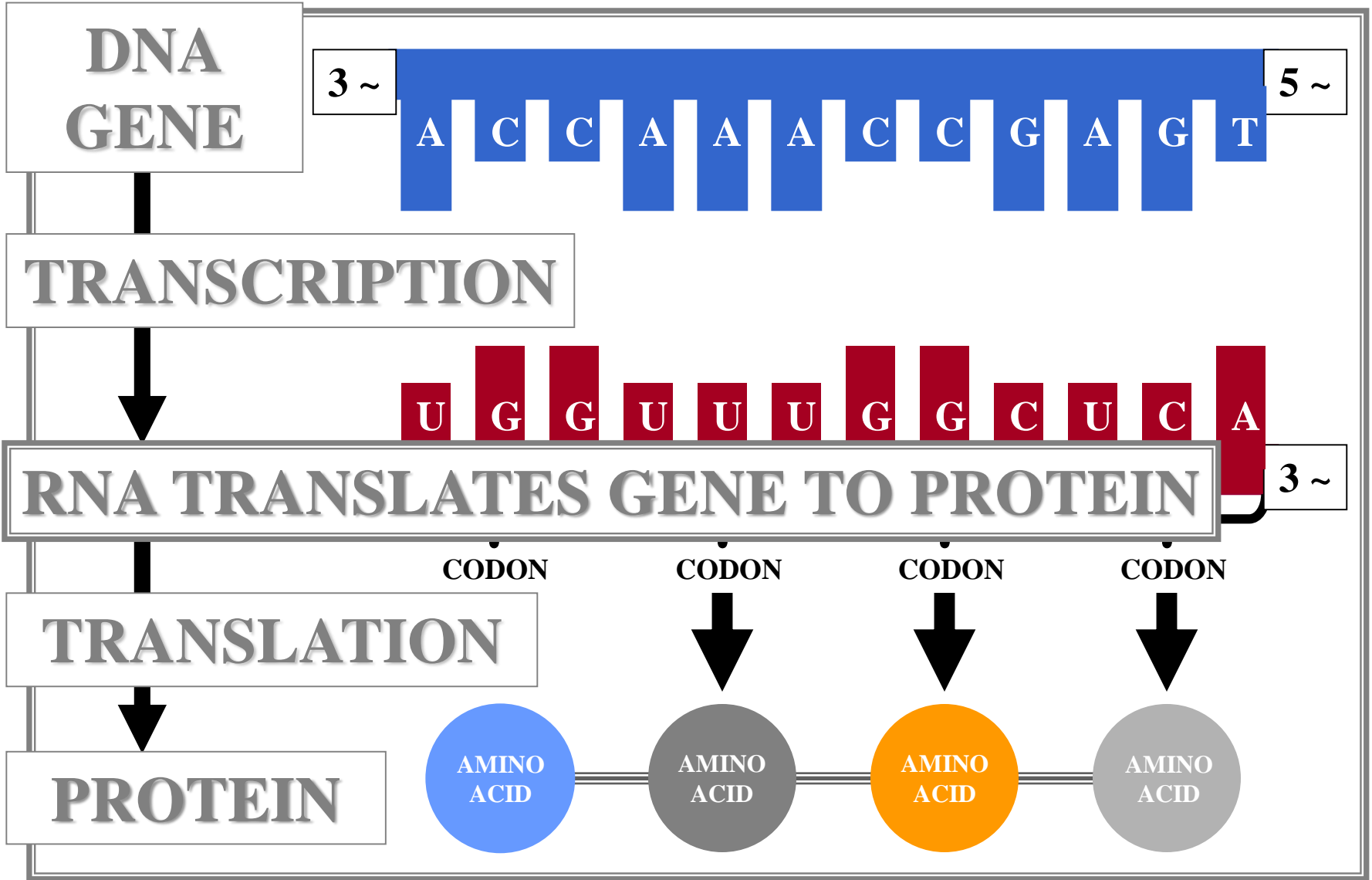



NUCLEIC ACID STRUCTURE



DNA STRUCTURE

QUESTION



**WHAT IS THE ACCEPTED
MODEL FOR THE
STRUCTURE OF DNA?**

QUESTION

DNA DEOXYRIBONUCLEIC ACID STRUCTURE

?

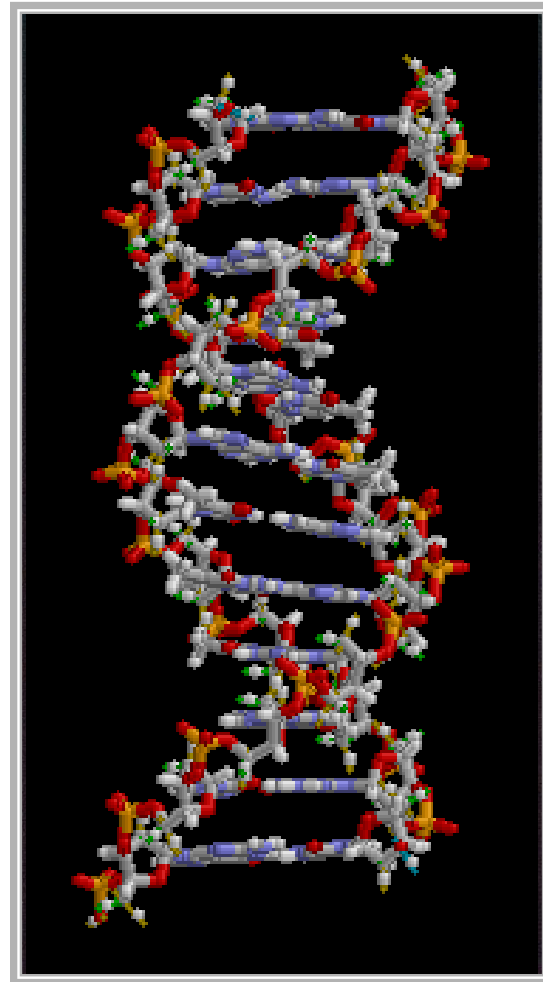

?

DNA DEOXYRIBONUCLEIC ACID STRUCTURE

**DOUBLE
HELIX
MODEL**

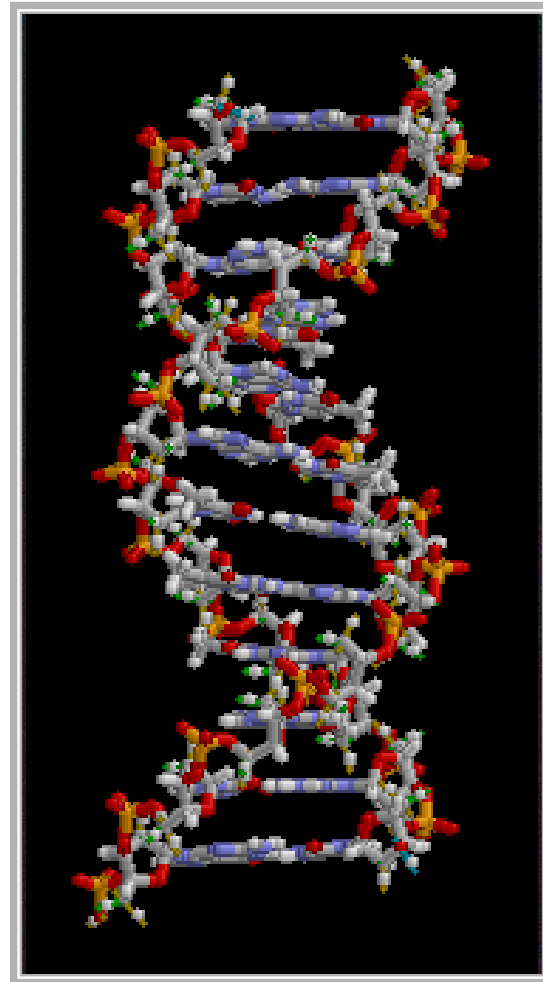

**DOUBLE
HELIX
MODEL**



ANSWER

**DOUBLE HELIX
MODEL**

ANSWER



DOUBLE HELIX MODEL

QUESTION



**WHO WERE THE
SCIENTISTS THAT
PROPOSED THE DNA
DOUBLE HELIX MODEL?**

QUESTION

DOUBLE HELIX MODEL

A



ANSWER



**JAMES WATSON
&
FRANCIS CRICK**

ANSWER

DOUBLE HELIX MODEL



JAMES WATSON

FRANCIS CRICK

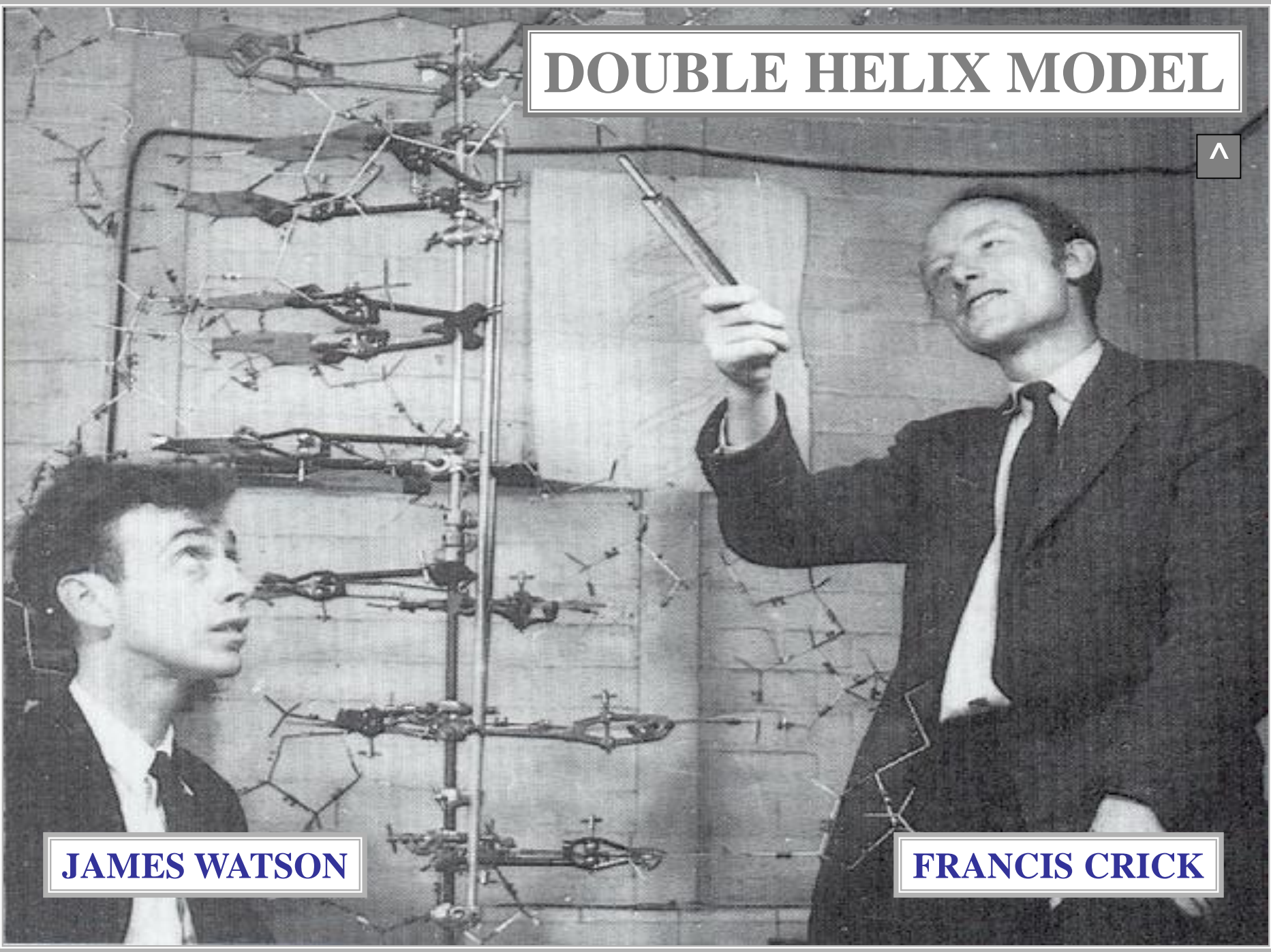



POLYNUCLEOTIDE CHAINS

DNA NUCLEOTIDE

STRUCTURAL COMPONENTS

SUGAR
PHOSPHATE
NITROGENOUS BASE

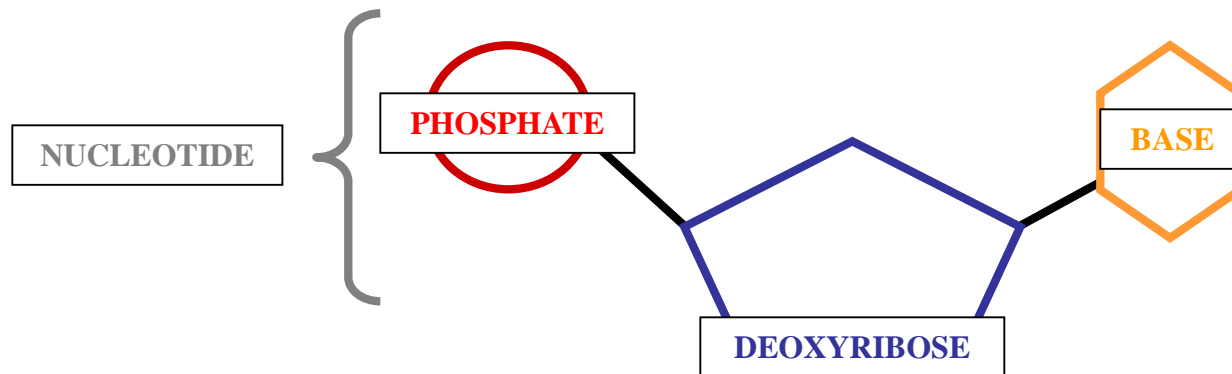
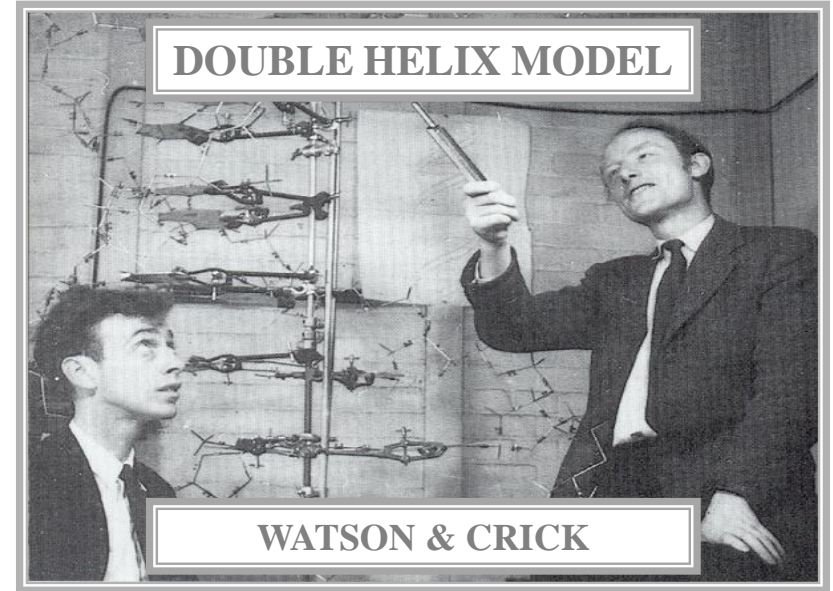

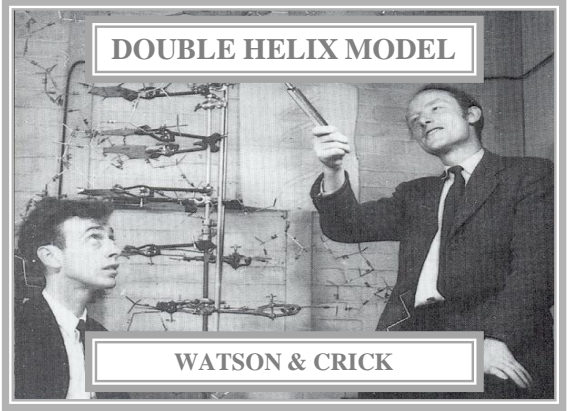
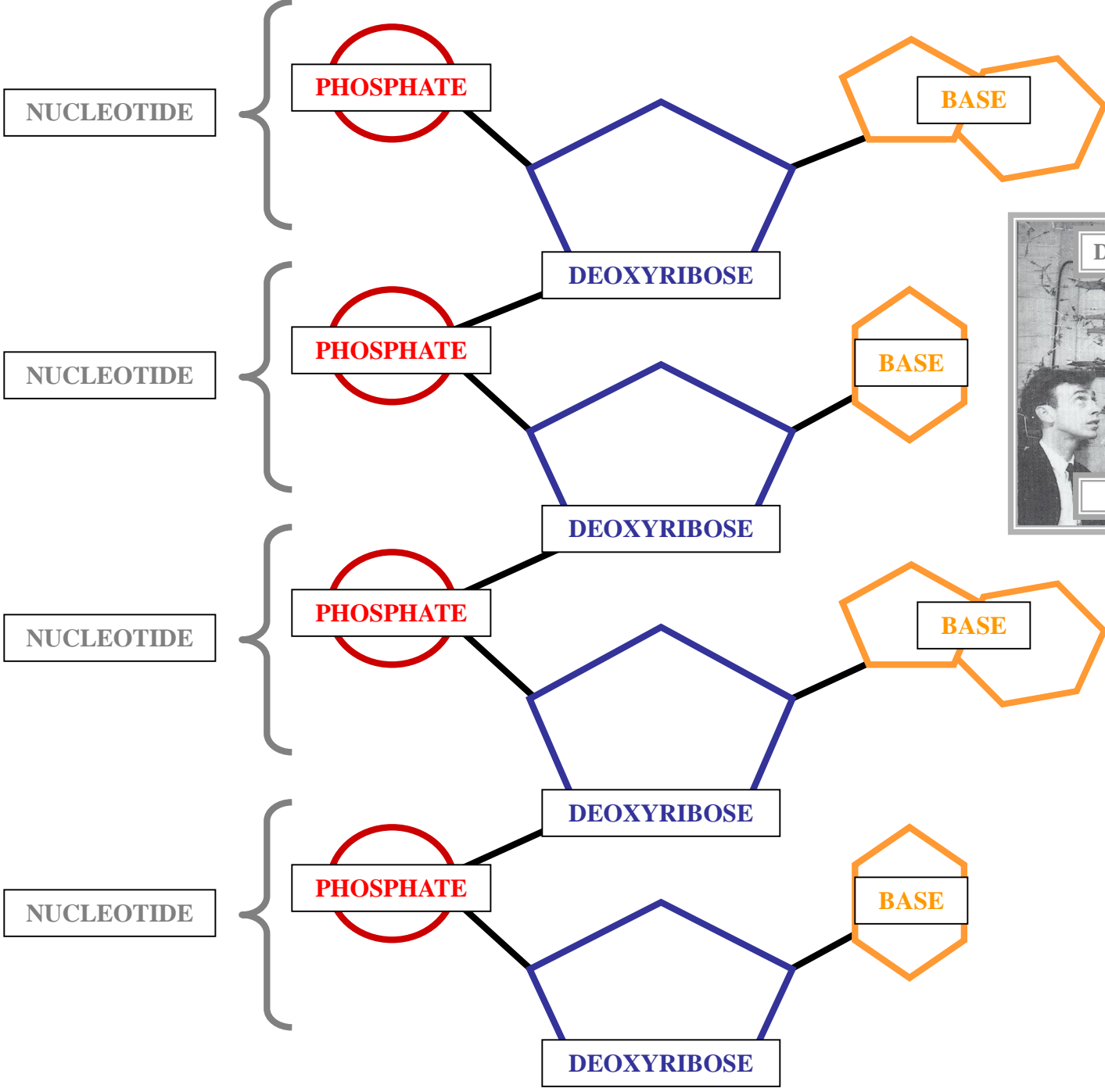

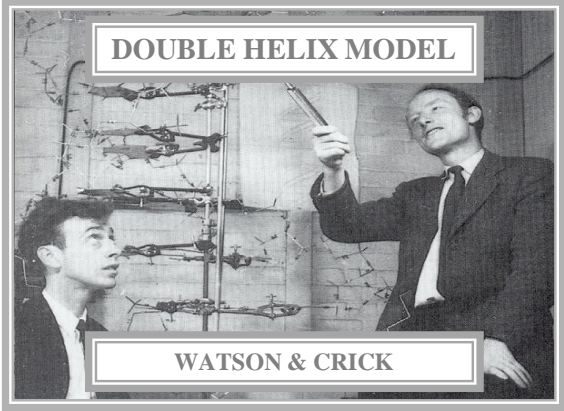
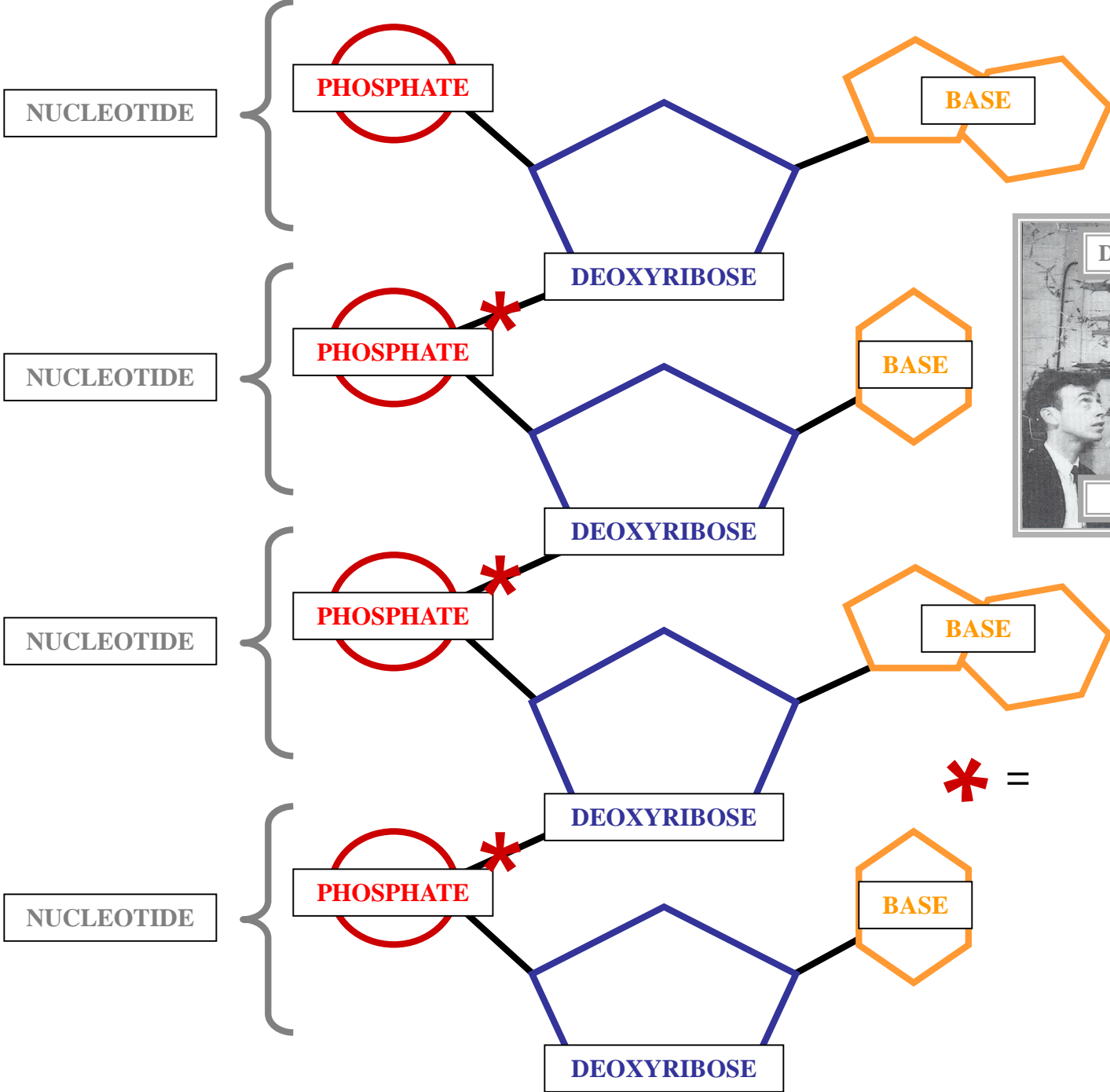

* = ?
BOND

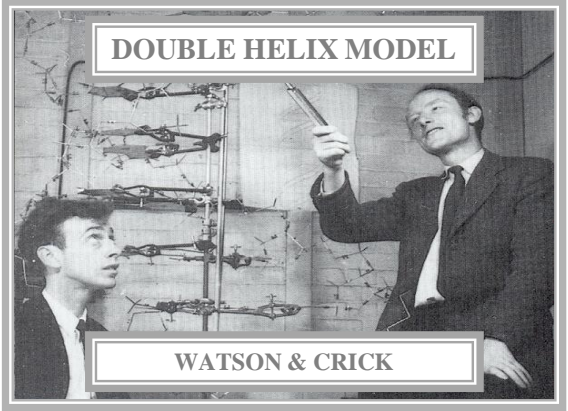
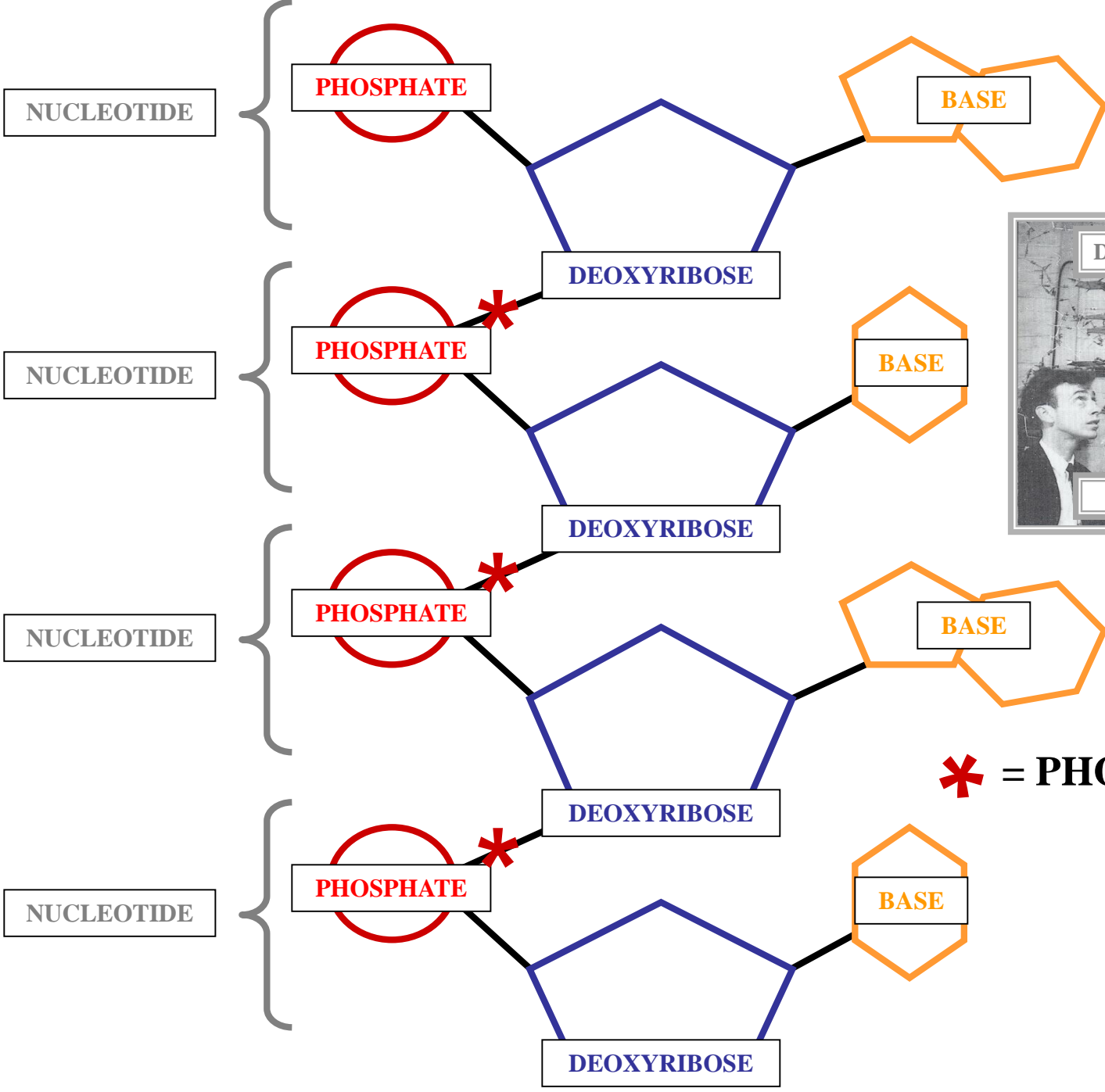

* = PHOSPHODIESTER BOND

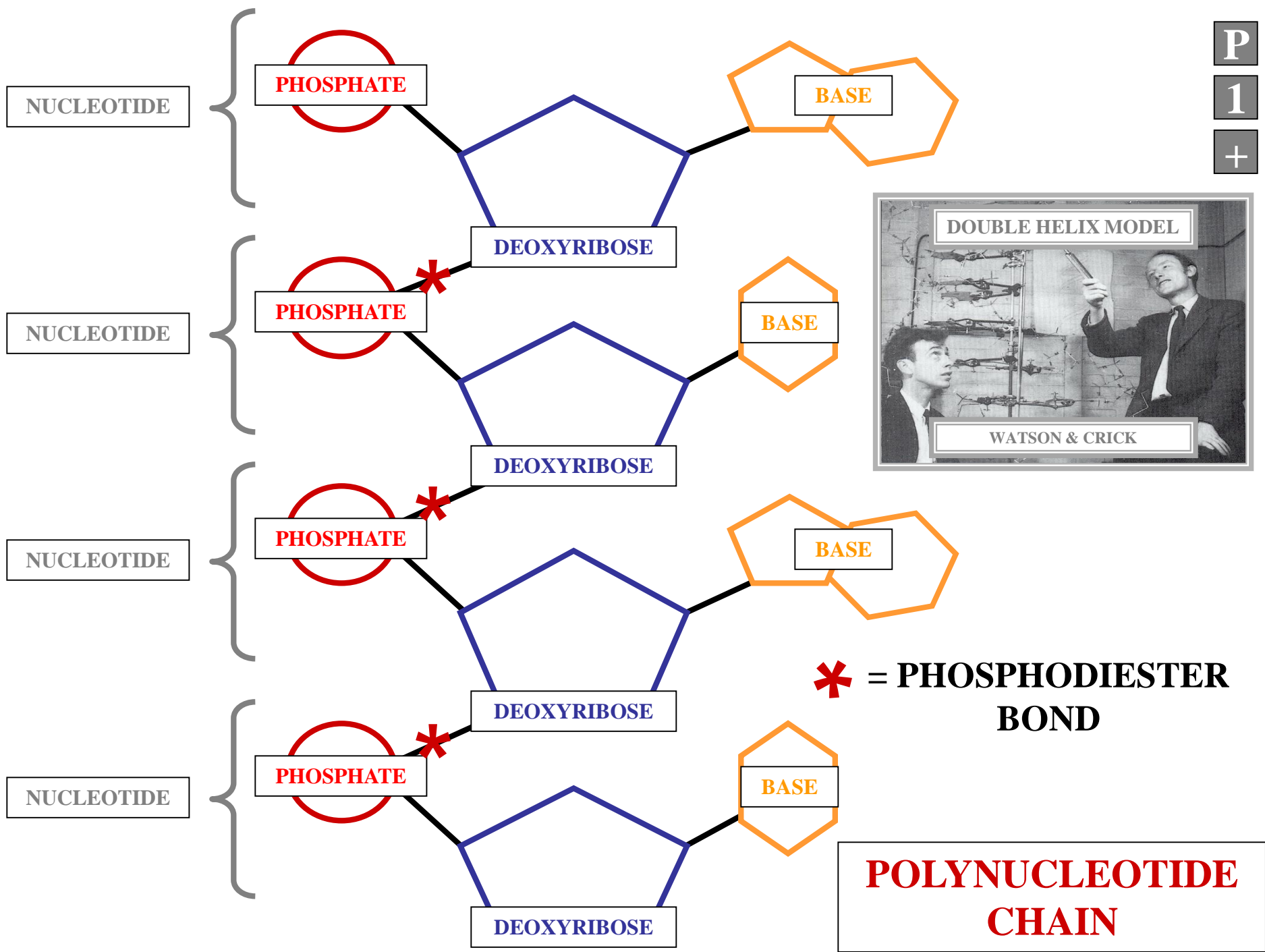

DNA DOUBLE HELIX MODEL

P
2
+

POLYNUCLEOTIDE CHAIN

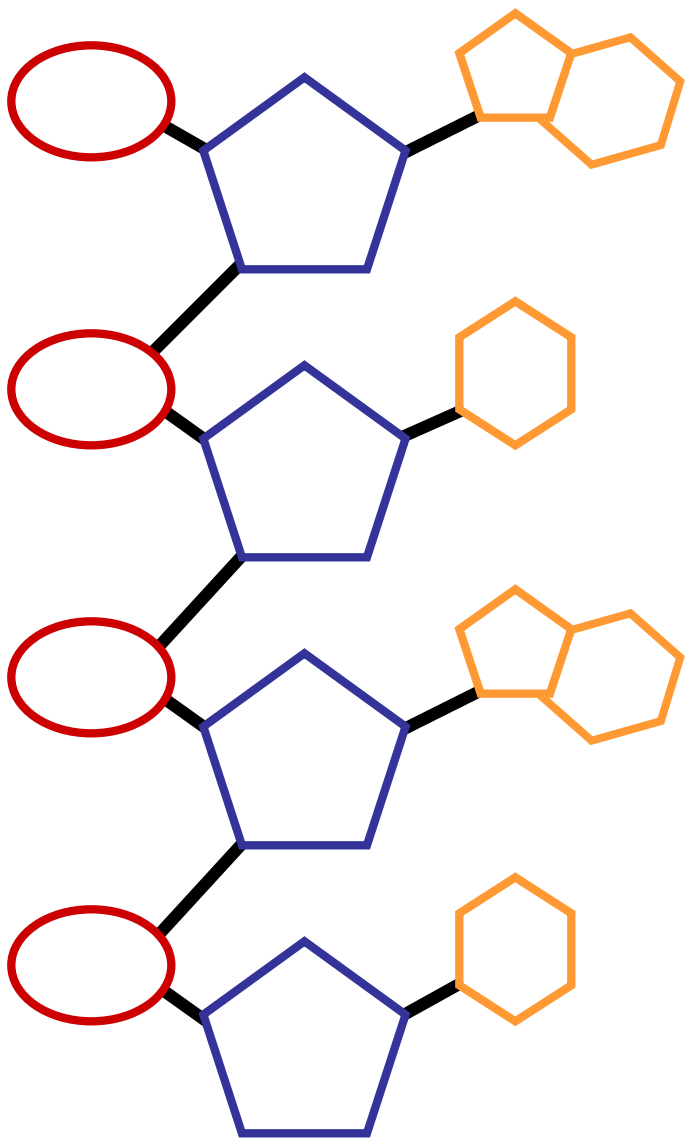

FIRST
POLYNUCLEOTIDE
CHAIN

DNA DOUBLE HELIX MODEL

POLYNUCLEOTIDE CHAIN

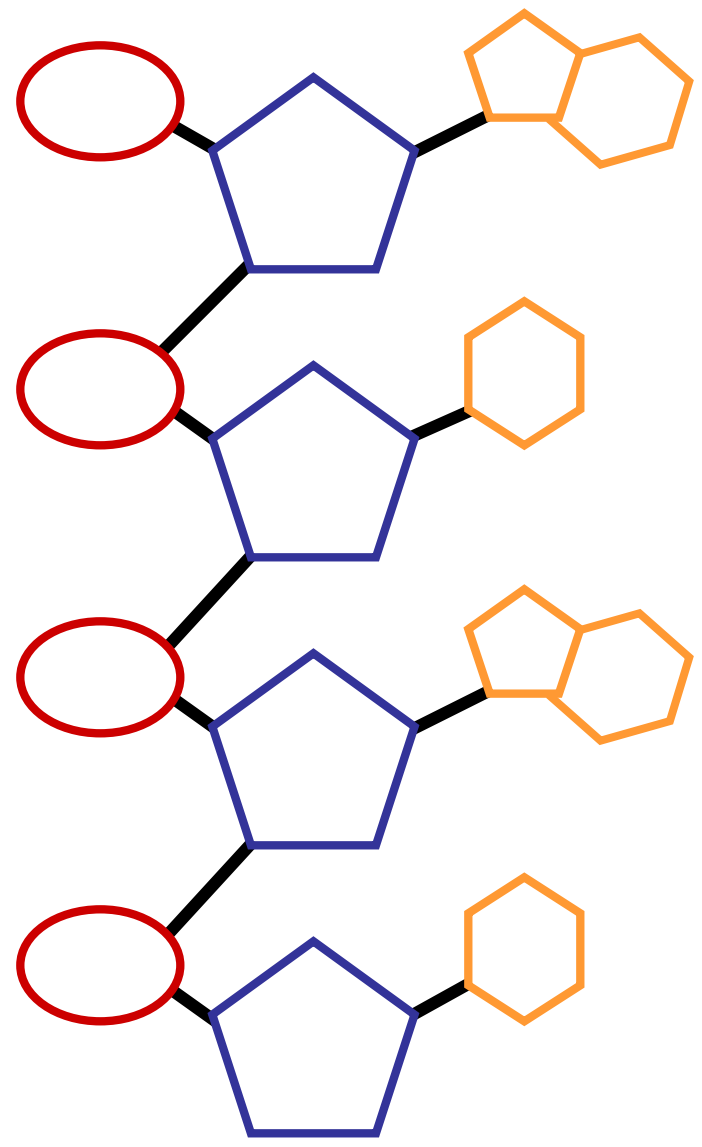

FIRST
POLYNUCLEOTIDE
CHAIN

POLYNUCLEOTIDE CHAIN

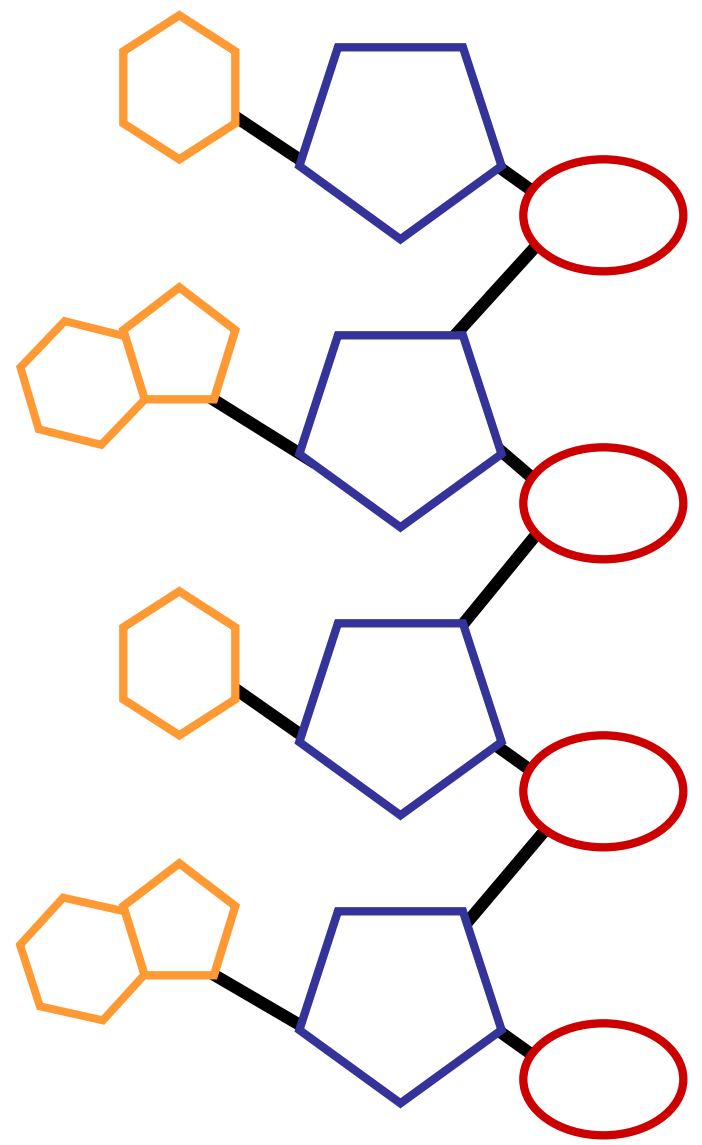

SECOND
POLYNUCLEOTIDE
CHAIN

DNA DOUBLE HELIX MODEL

PARALLEL POLYNUCLEOTIDE CHAIN

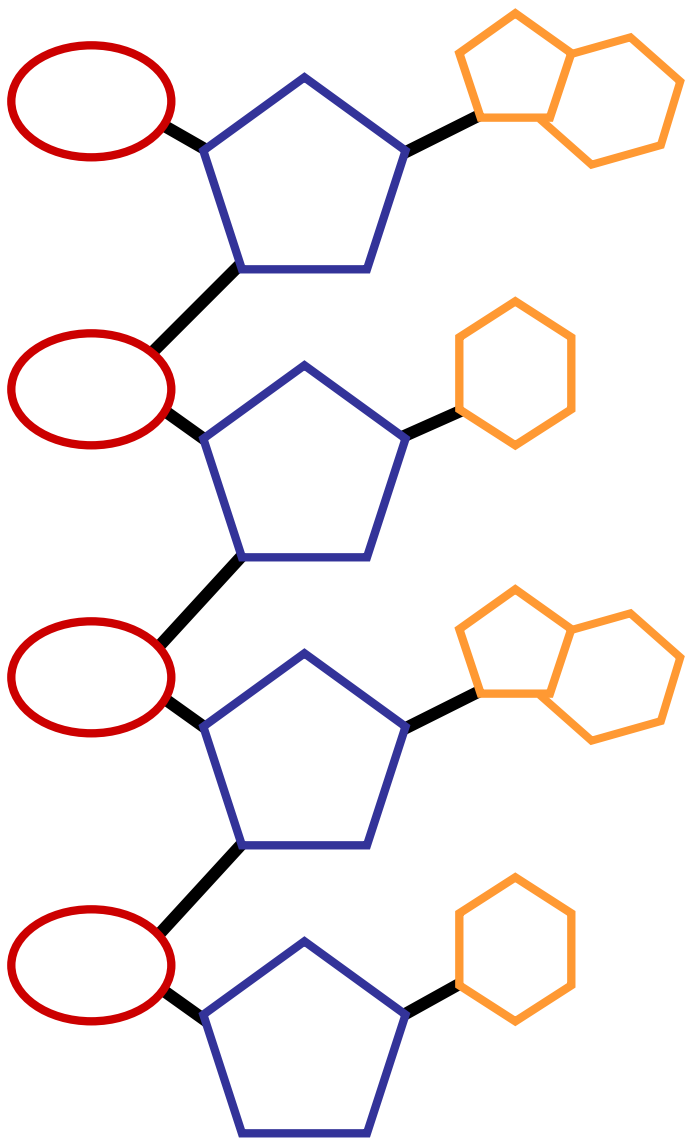

FIRST
POLYNUCLEOTIDE
CHAIN

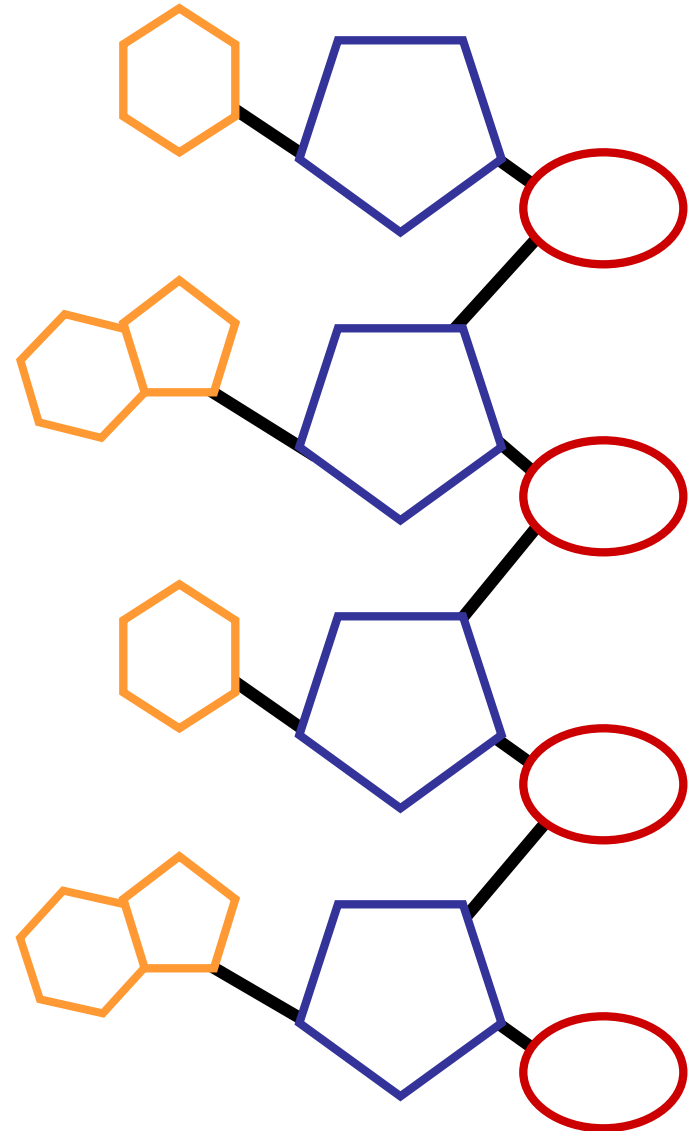

SECOND
POLYNUCLEOTIDE
CHAIN

PARALLEL POLYNUCLEOTIDE CHAIN

P
B

**POLYNUCLEOTIDE
CHAIN
BACKBONE**

POLYNUCLEOTIDE CHAIN BACKBONE



BACKBONE

CONSISTS NUCLEOTIDE

DEOXYRIBOSE

PHOSPHATE

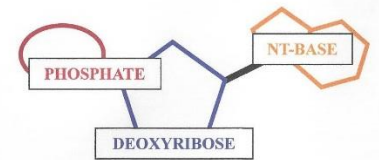
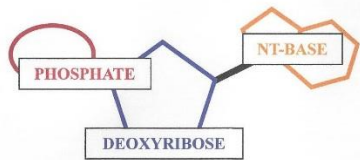

POLYNUCLEOTIDE CHAIN BACKBONE

DNA DOUBLE HELIX MODEL

PARALLEL POLYNUCLEOTIDE CHAIN

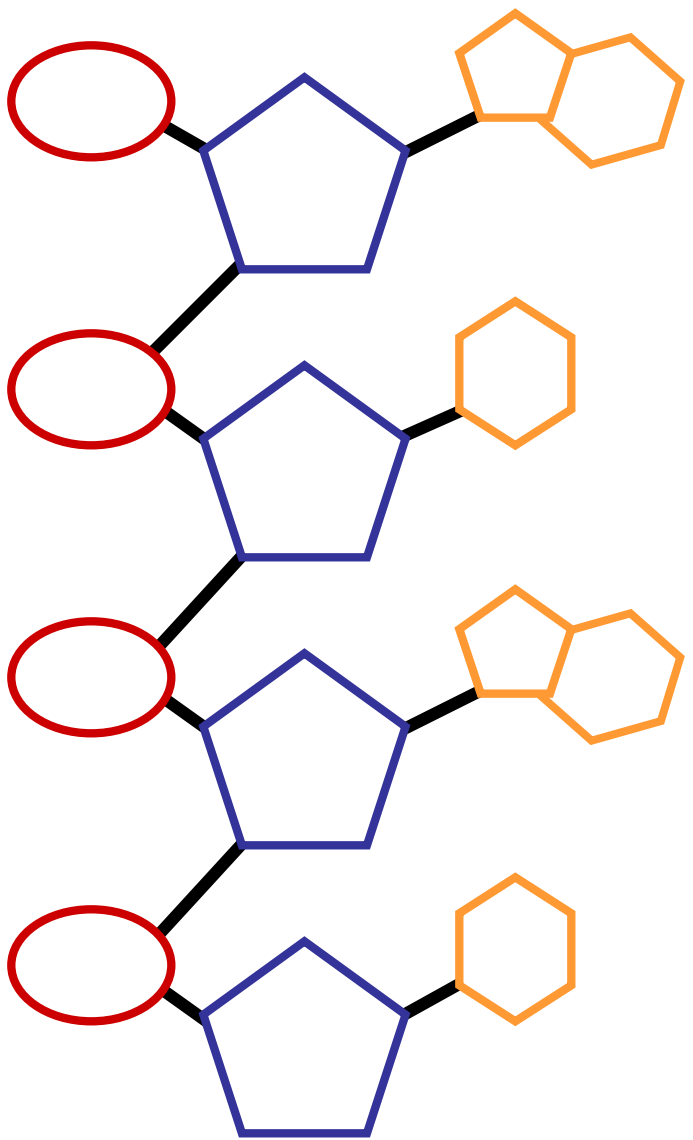

FIRST
POLYNUCLEOTIDE
CHAIN

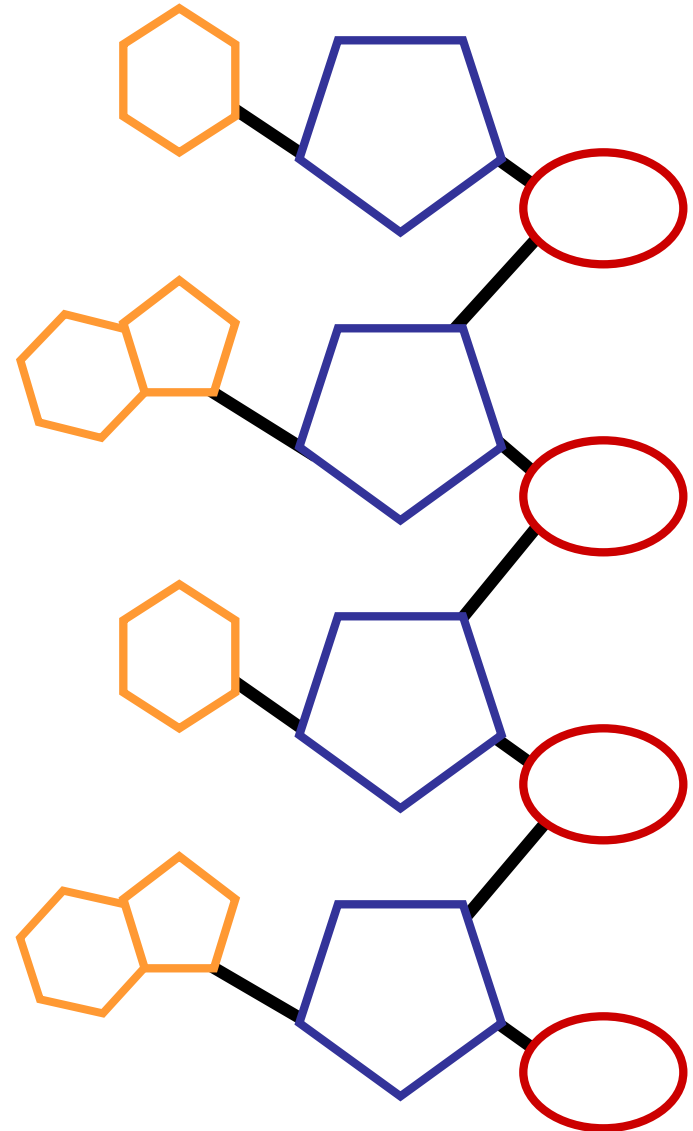

SECOND
POLYNUCLEOTIDE
CHAIN

PARALLEL POLYNUCLEOTIDE CHAIN

DNA DOUBLE HELIX MODEL

2
B

PARALLEL POLYNUCLEOTIDE CHAIN

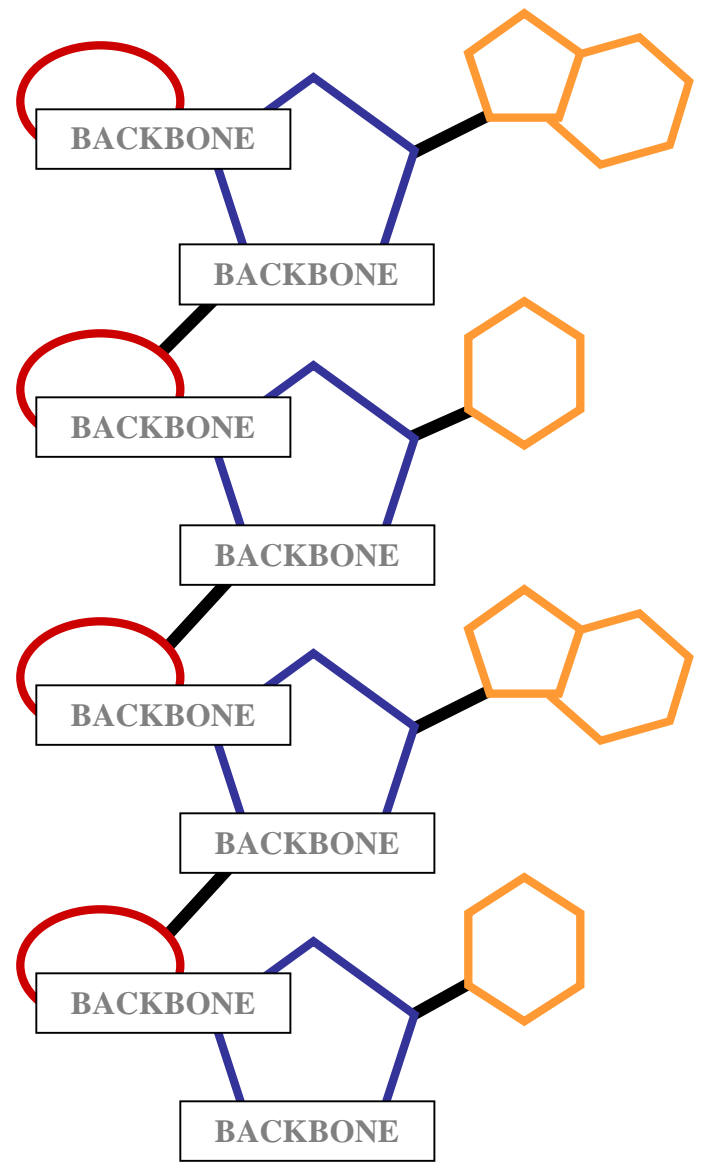

FIRST
POLYNUCLEOTIDE
CHAIN

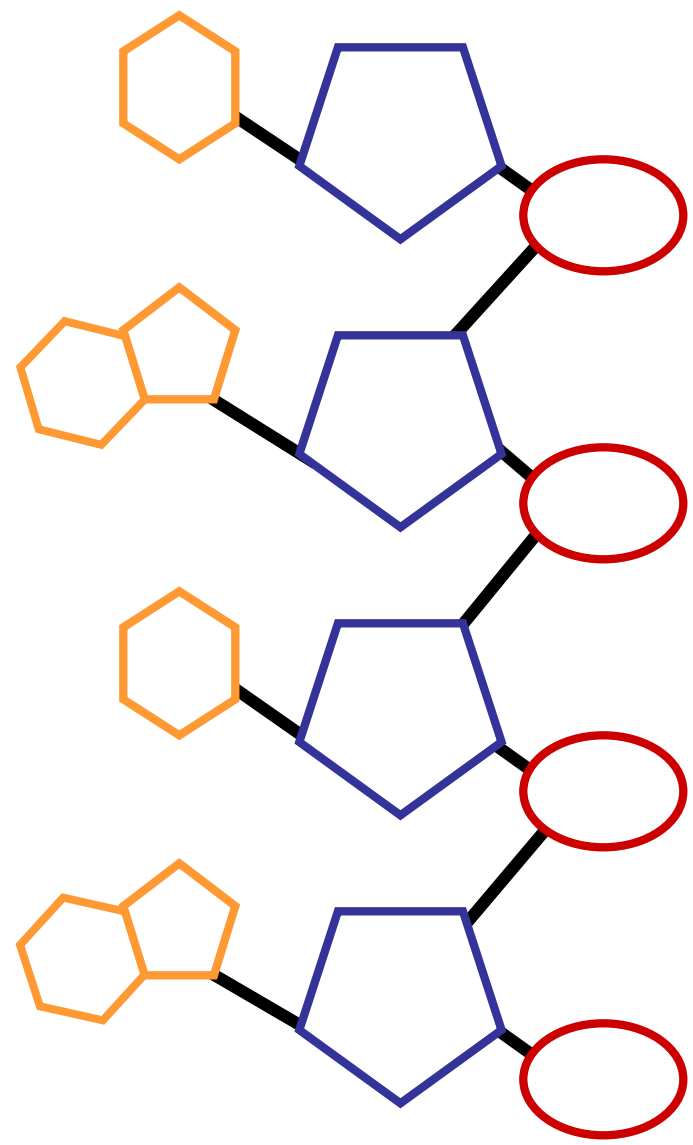

SECOND
POLYNUCLEOTIDE
CHAIN

PARALLEL POLYNUCLEOTIDE CHAIN

DNA DOUBLE HELIX MODEL

PARALLEL POLYNUCLEOTIDE CHAIN

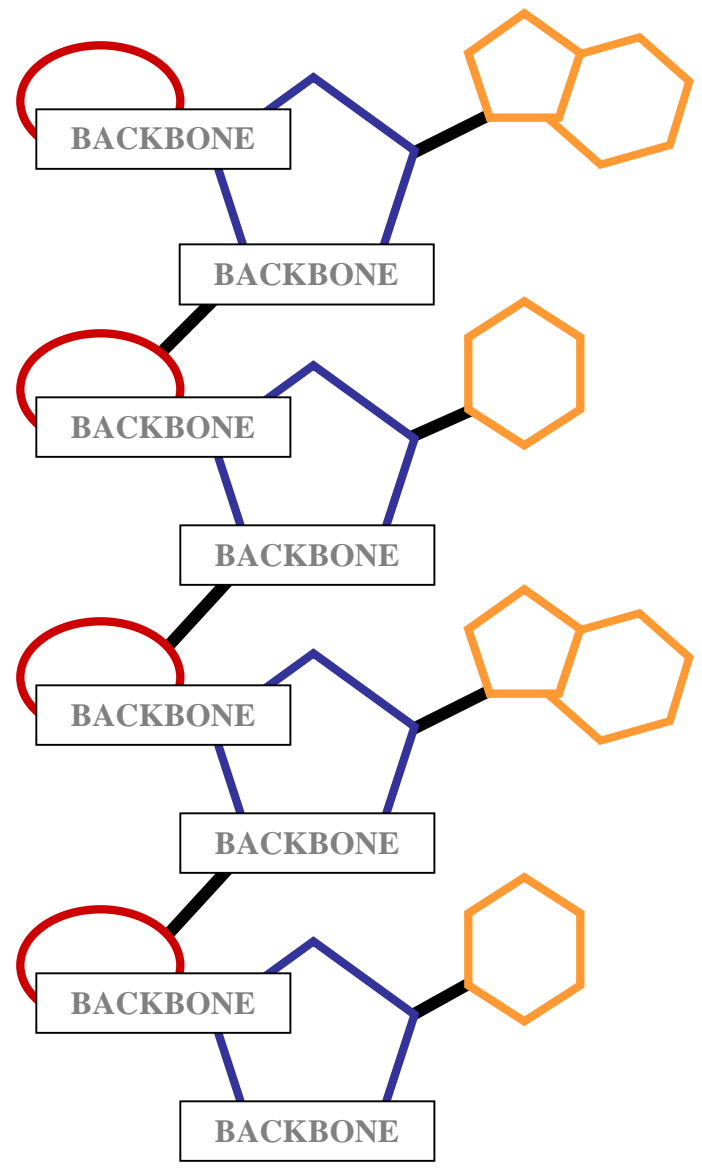

FIRST
POLYNUCLEOTIDE
CHAIN

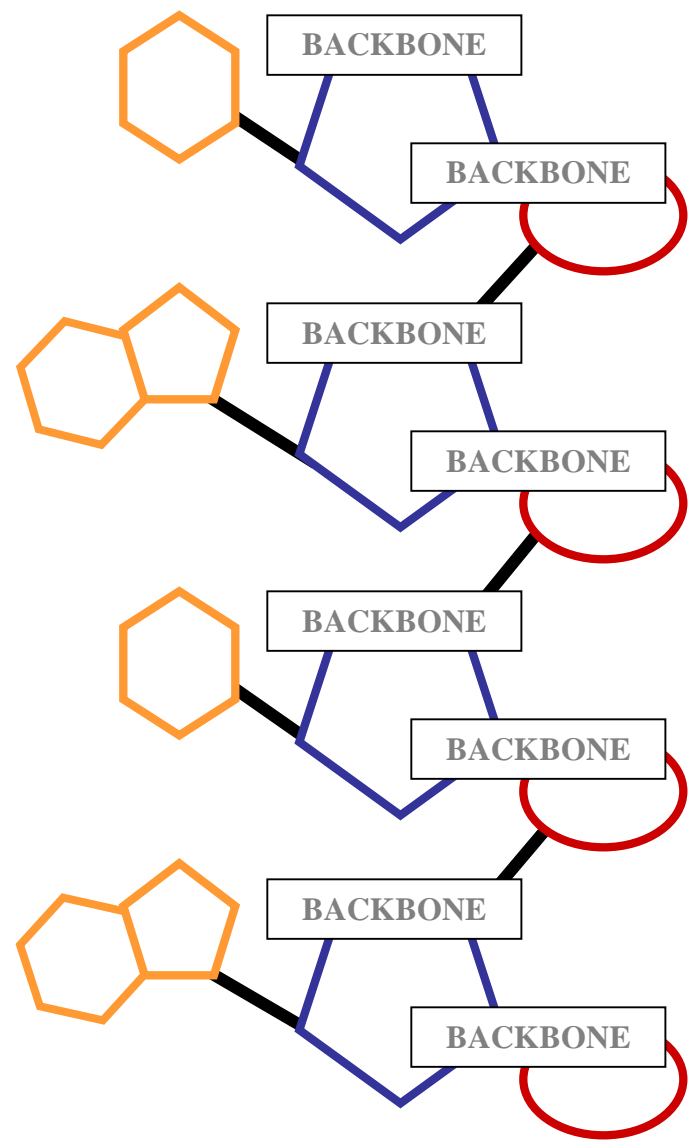

SECOND
POLYNUCLEOTIDE
CHAIN

PARALLEL POLYNUCLEOTIDE CHAIN

DNA DOUBLE HELIX MODEL

PARALLEL POLYNUCLEOTIDE CHAIN

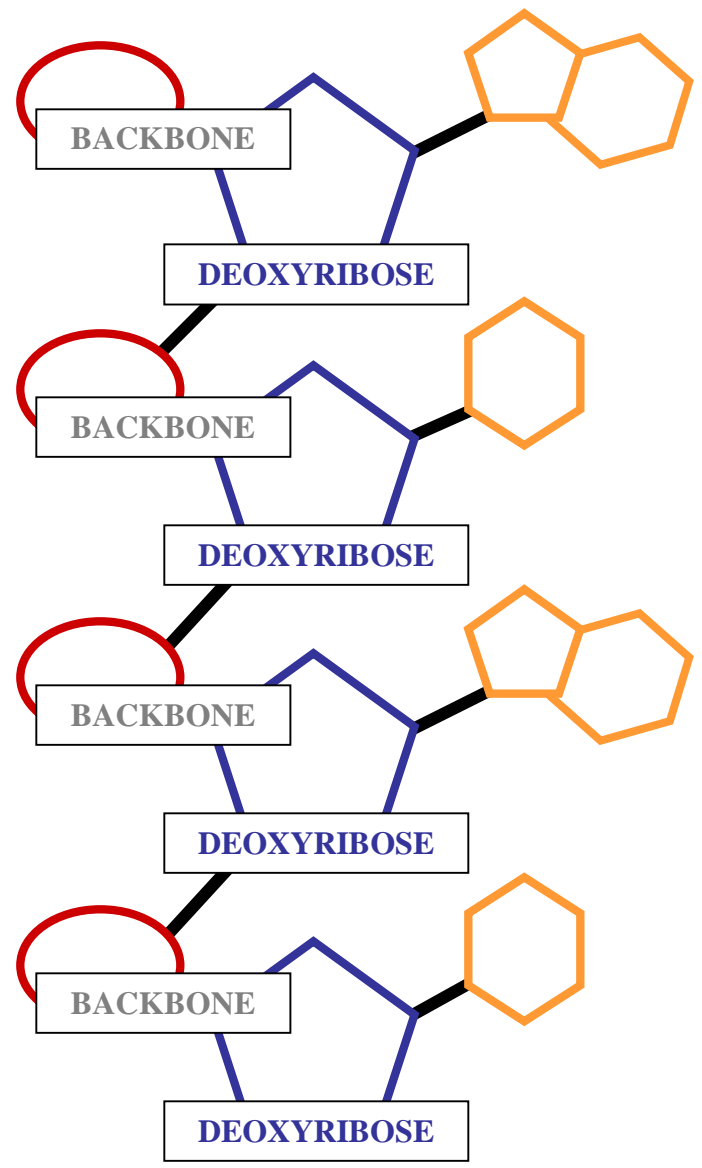

FIRST
POLYNUCLEOTIDE
CHAIN

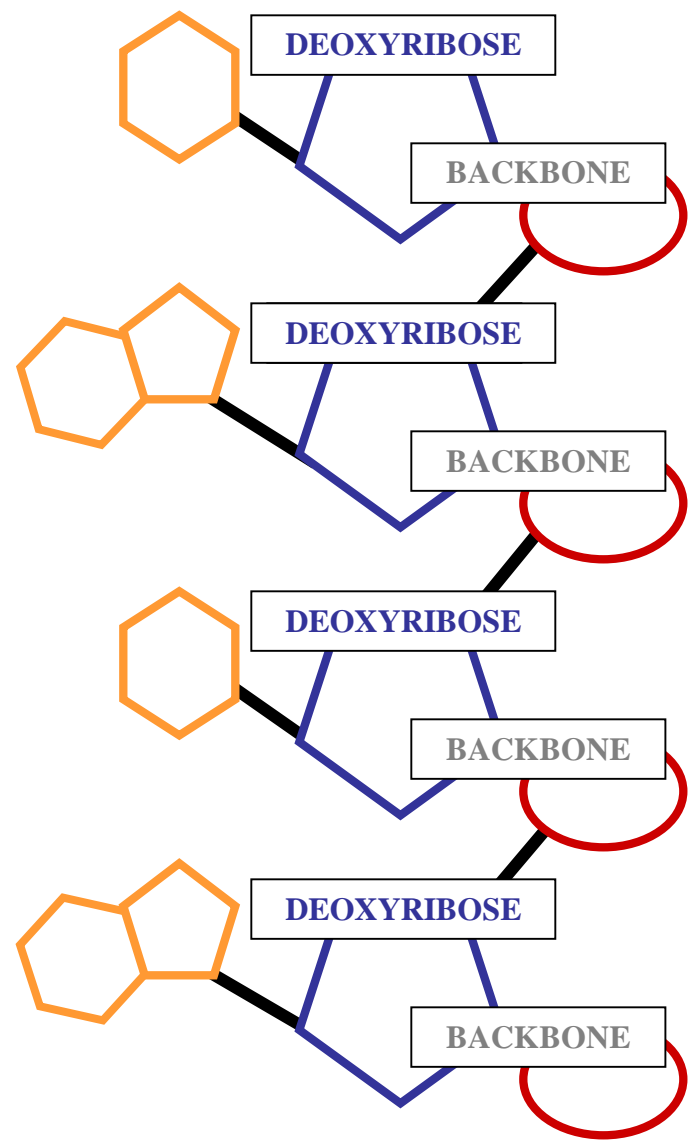

SECOND
POLYNUCLEOTIDE
CHAIN

PARALLEL POLYNUCLEOTIDE CHAIN

DNA DOUBLE HELIX MODEL

PARALLEL POLYNUCLEOTIDE CHAIN

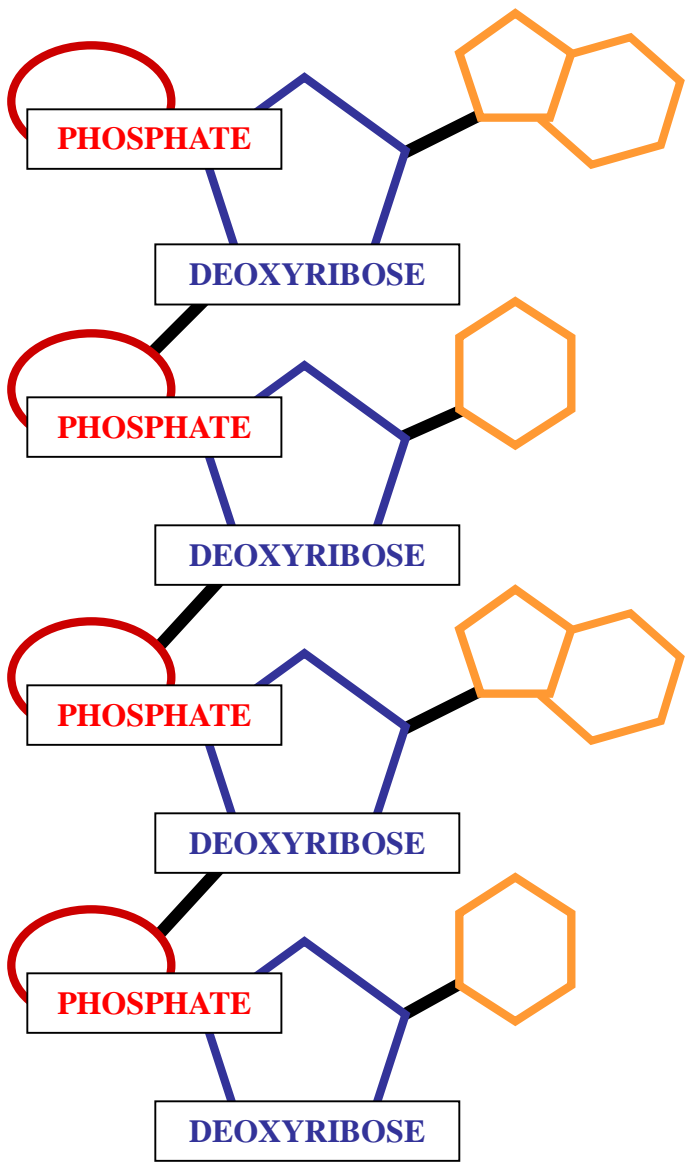

FIRST
POLYNUCLEOTIDE
CHAIN

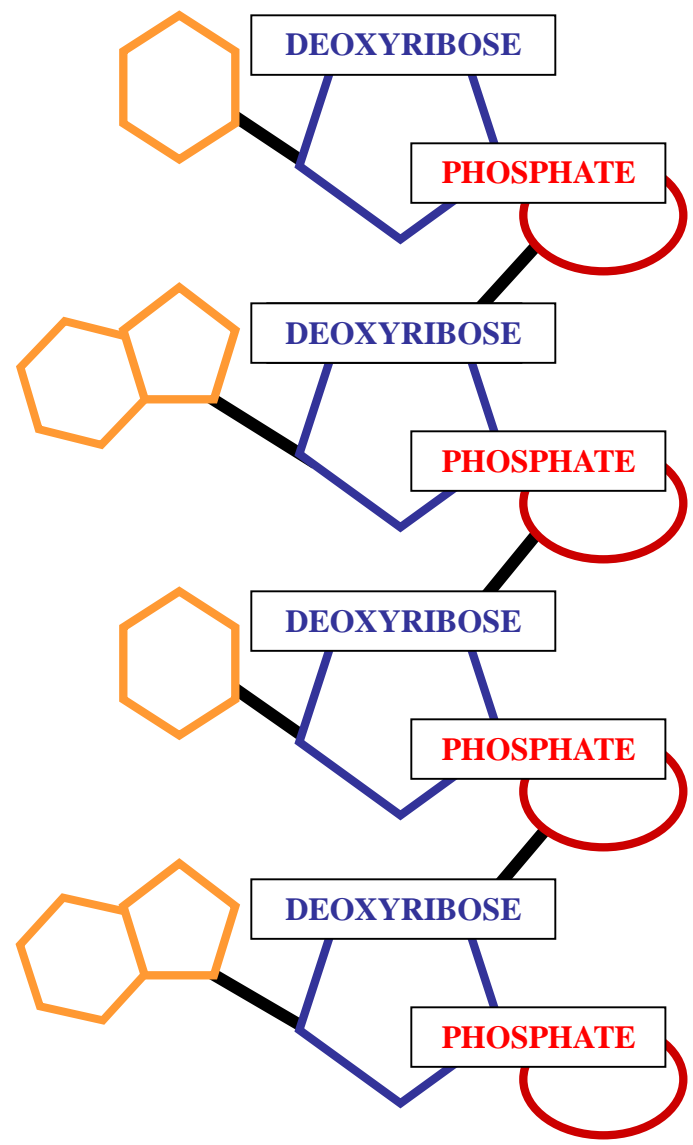

SECOND
POLYNUCLEOTIDE
CHAIN

PARALLEL POLYNUCLEOTIDE CHAIN

P
R

POLYNUCLEOTIDE
CHAIN
RUNGS

POLYNUCLEOTIDE CHAIN RUNGS



RUNGS
CONSIST NUCLEOTIDE

BASES

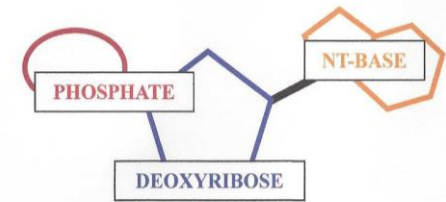
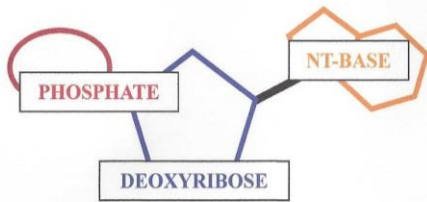

POLYNUCLEOTIDE CHAIN
RUNGS

DNA DOUBLE HELIX MODEL

1
R

PARALLEL POLYNUCLEOTIDE CHAIN

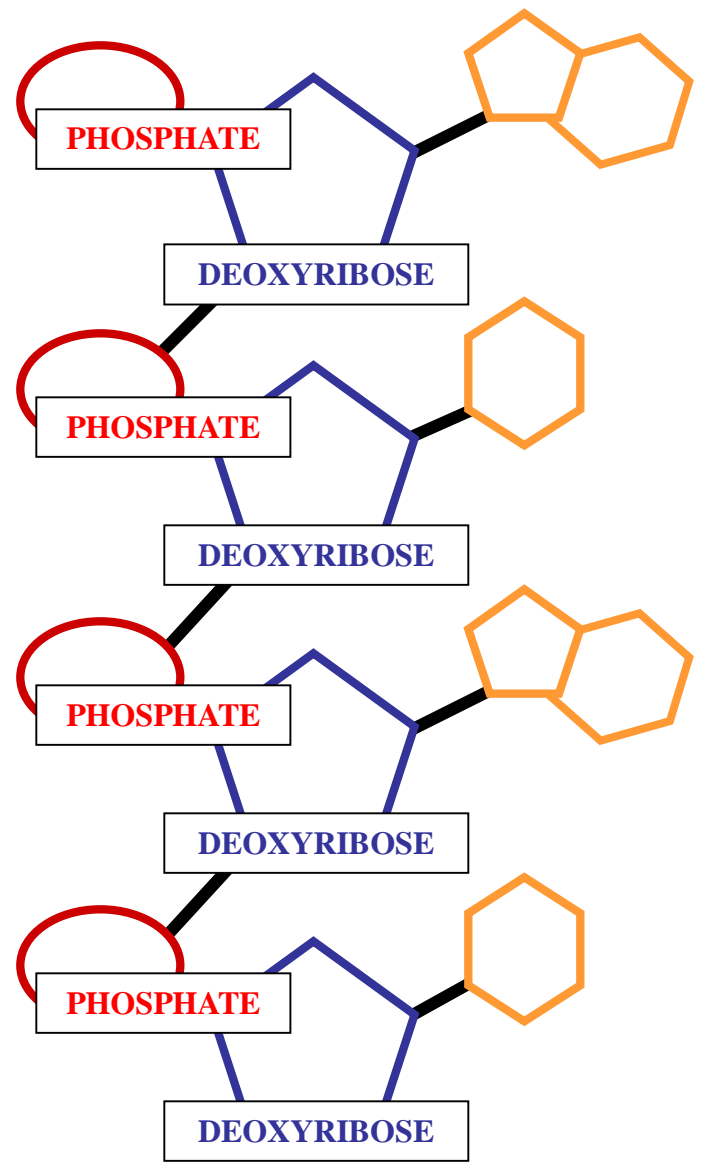

FIRST
POLYNUCLEOTIDE
CHAIN

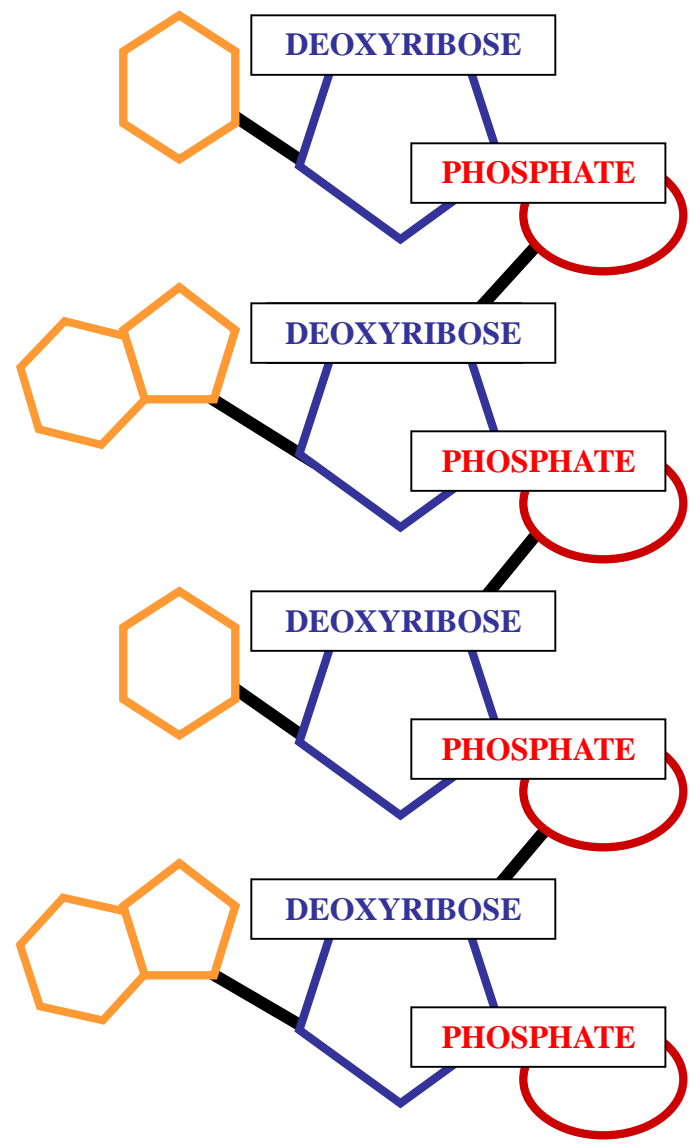

SECOND
POLYNUCLEOTIDE
CHAIN

PARALLEL POLYNUCLEOTIDE CHAIN

DNA DOUBLE HELIX MODEL

PARALLEL POLYNUCLEOTIDE CHAIN

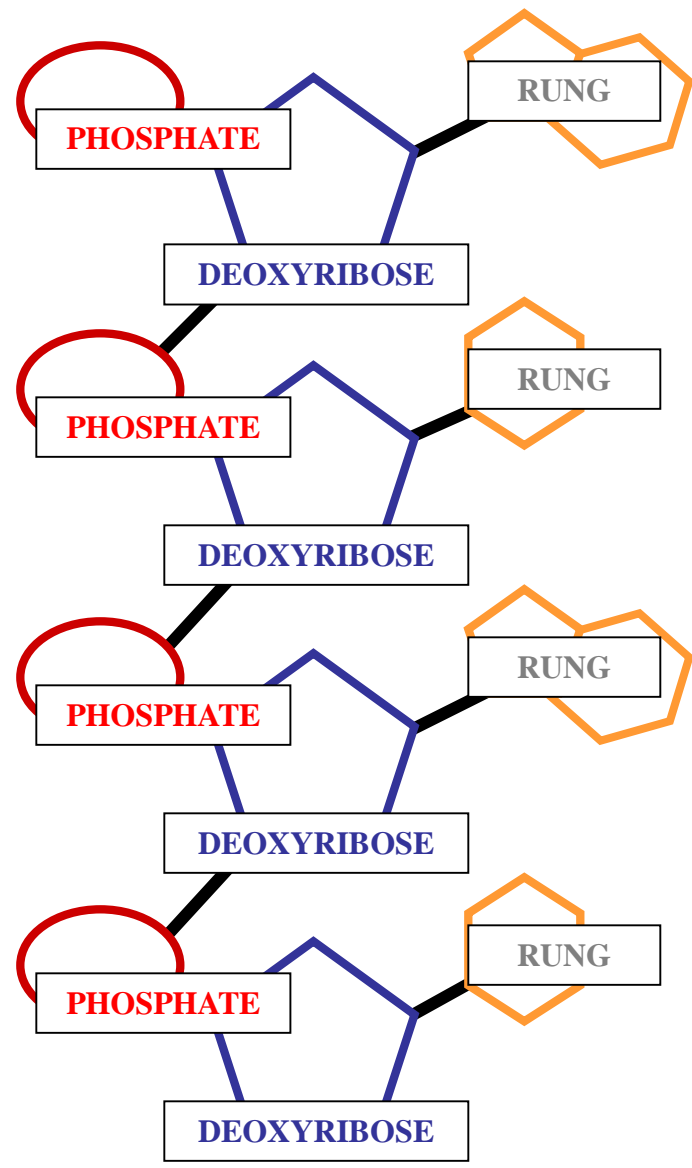

FIRST
POLYNUCLEOTIDE
CHAIN

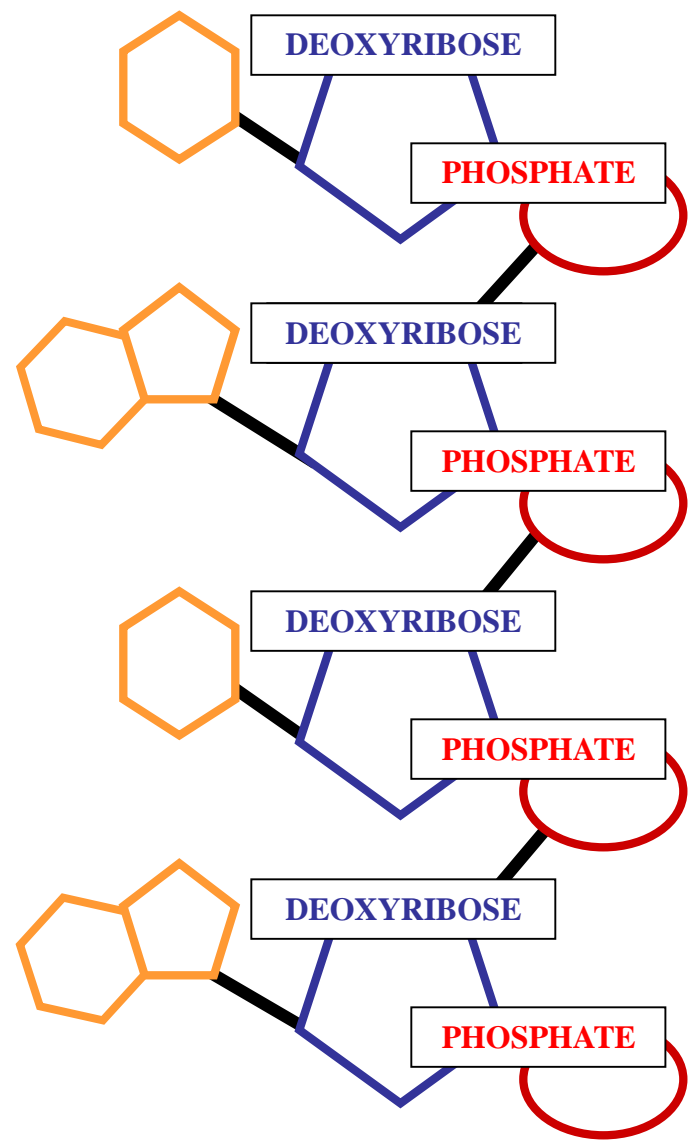

SECOND
POLYNUCLEOTIDE
CHAIN

PARALLEL POLYNUCLEOTIDE CHAIN

DNA DOUBLE HELIX MODEL

NB

PARALLEL POLYNUCLEOTIDE CHAIN

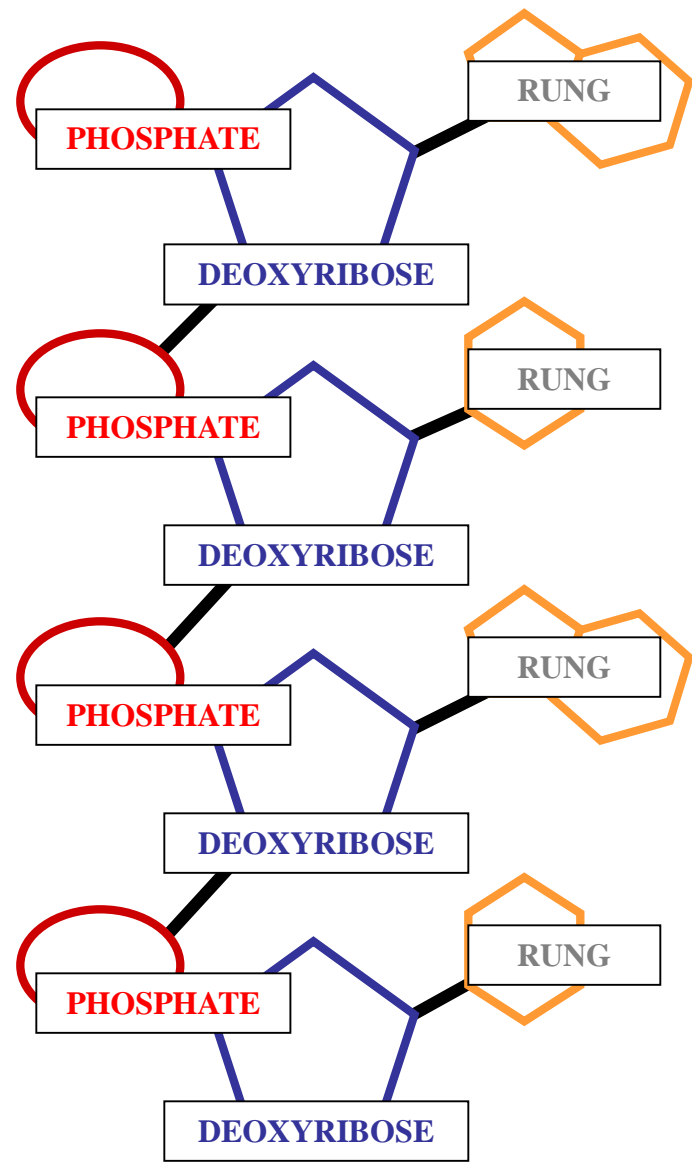

FIRST
POLYNUCLEOTIDE
CHAIN

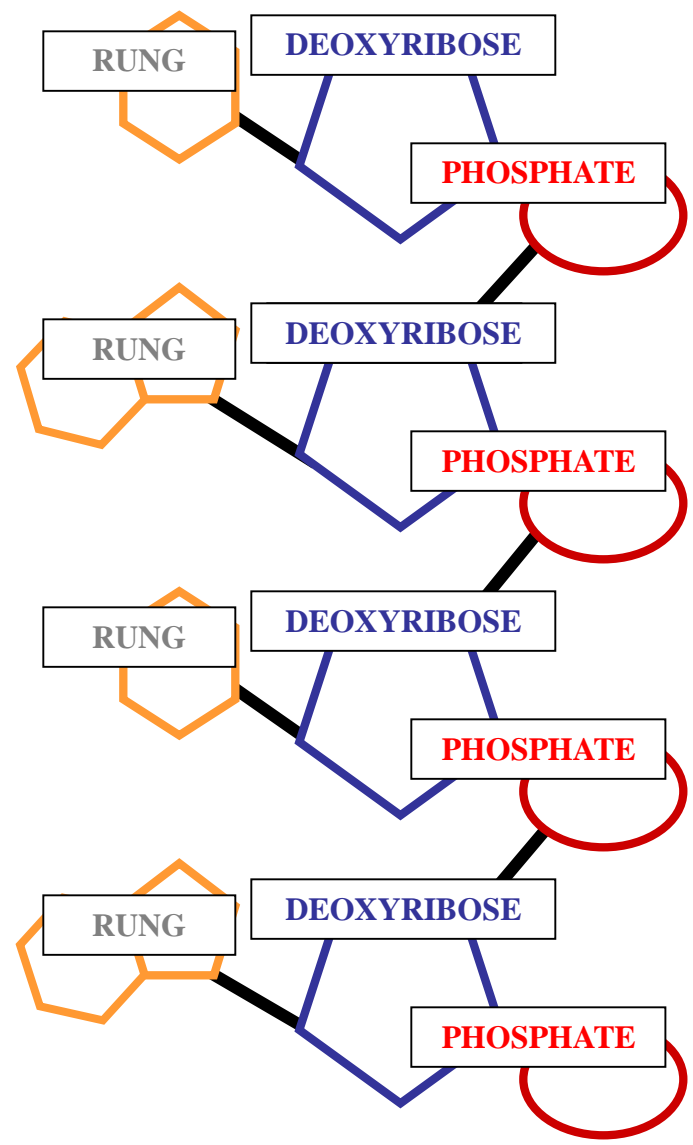

SECOND
POLYNUCLEOTIDE
CHAIN

PARALLEL POLYNUCLEOTIDE CHAIN

DNA DOUBLE HELIX MODEL

PARALLEL POLYNUCLEOTIDE CHAIN

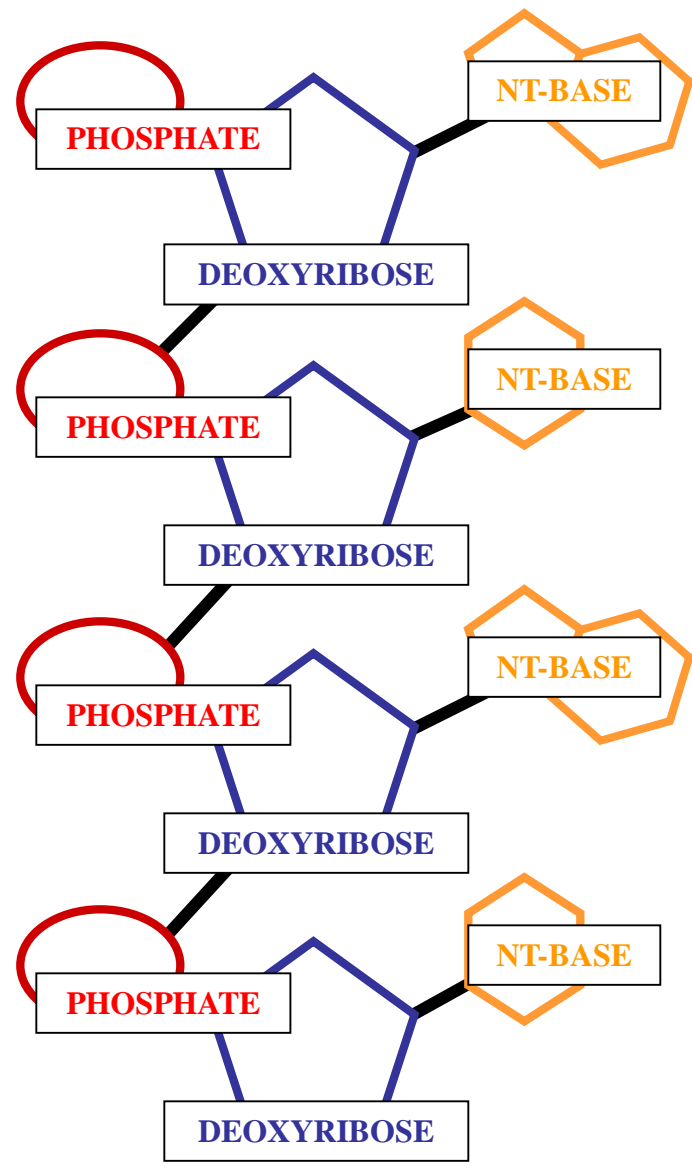

FIRST
POLYNUCLEOTIDE
CHAIN

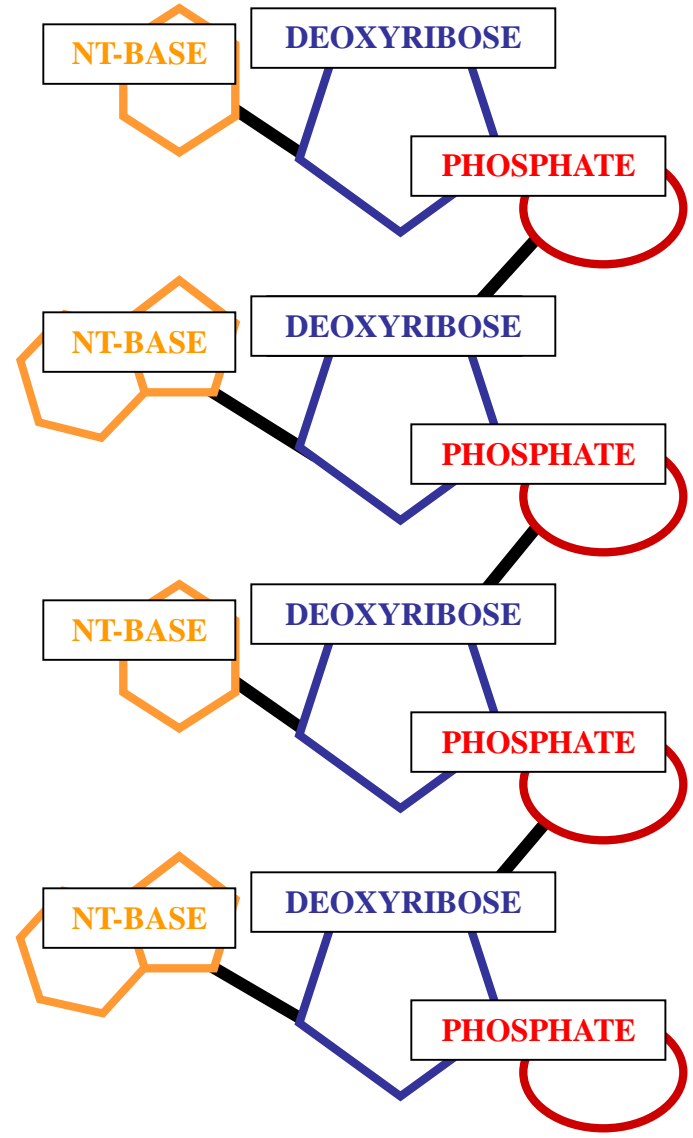

SECOND
POLYNUCLEOTIDE
CHAIN

PARALLEL POLYNUCLEOTIDE CHAIN



DNA DOUBLE HELIX MODEL

H-BONDS FORM BETWEEN NT-BASES
PARALLEL POLYNUCLEOTIDE CHAIN

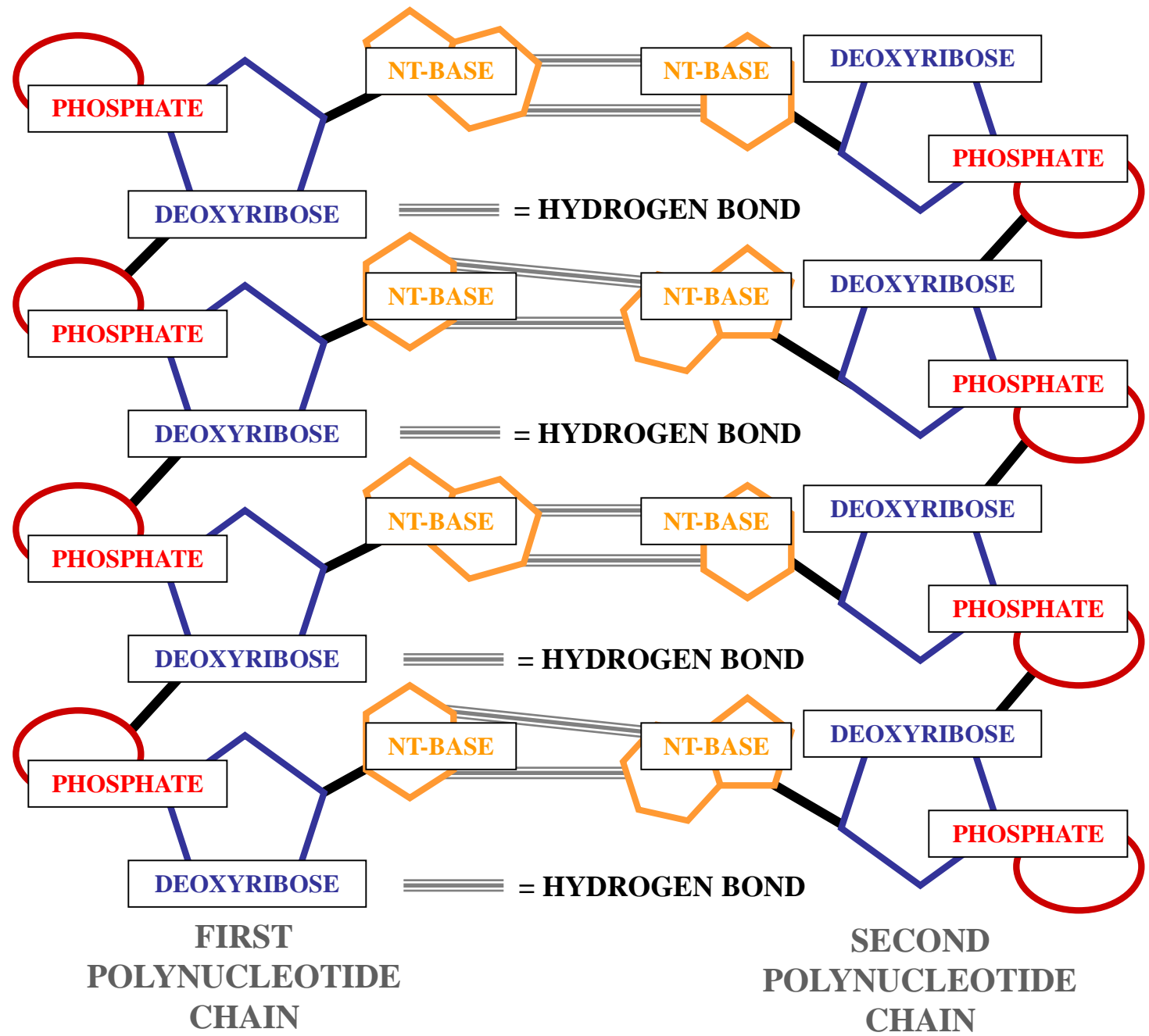

H-BONDS FORM BETWEEN NT-BASES
PARALLEL POLYNUCLEOTIDE CHAIN

DNA DOUBLE HELIX MODEL

H-BONDS LINK POLY-NT CHAINS
PARALLEL POLYNUCLEOTIDE CHAIN

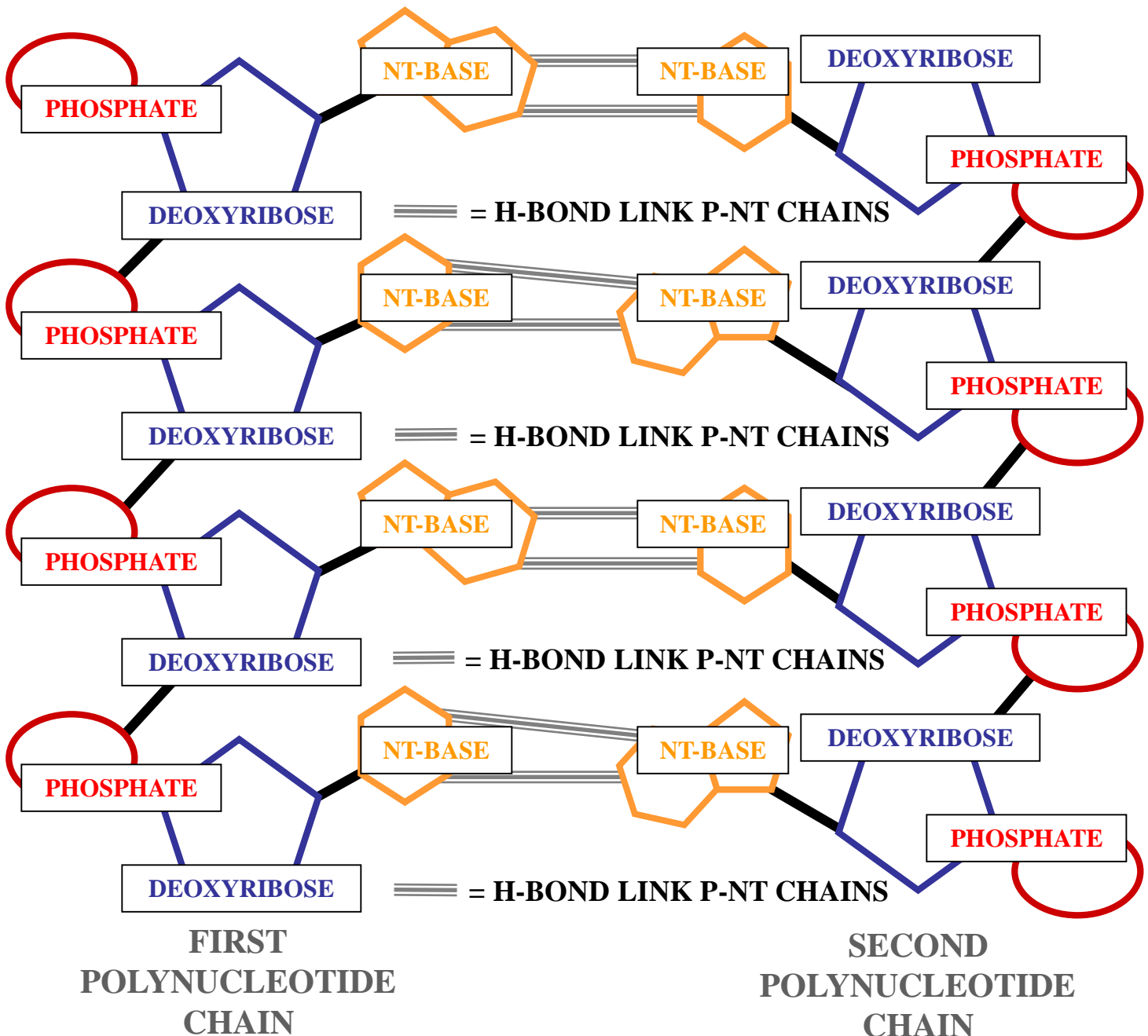

H-BONDS LINK POLY-NT CHAINS
PARALLEL POLYNUCLEOTIDE CHAIN



DNA DOUBLE HELIX MODEL

H-BONDS IMPART HELICAL STRUCTURE
PARALLEL POLYNUCLEOTIDE CHAIN

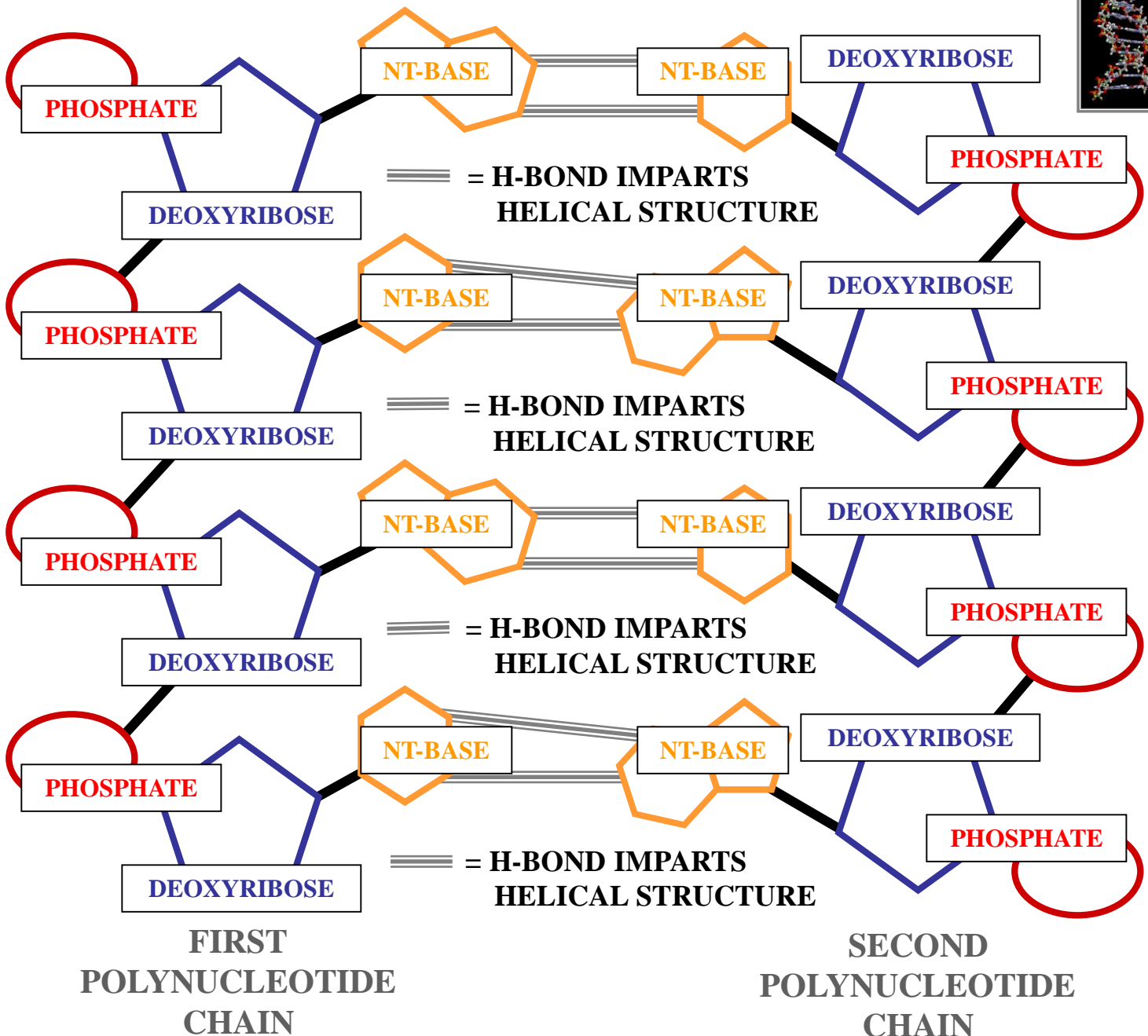

H-BONDS IMPART HELICAL STRUCTURE
PARALLEL POLYNUCLEOTIDE CHAIN +

**DOUBLE
HELIX
MODEL**

H-BONDS
IMPART
HELICAL
STRUCTURE

**DOUBLE
HELIX
MODEL**

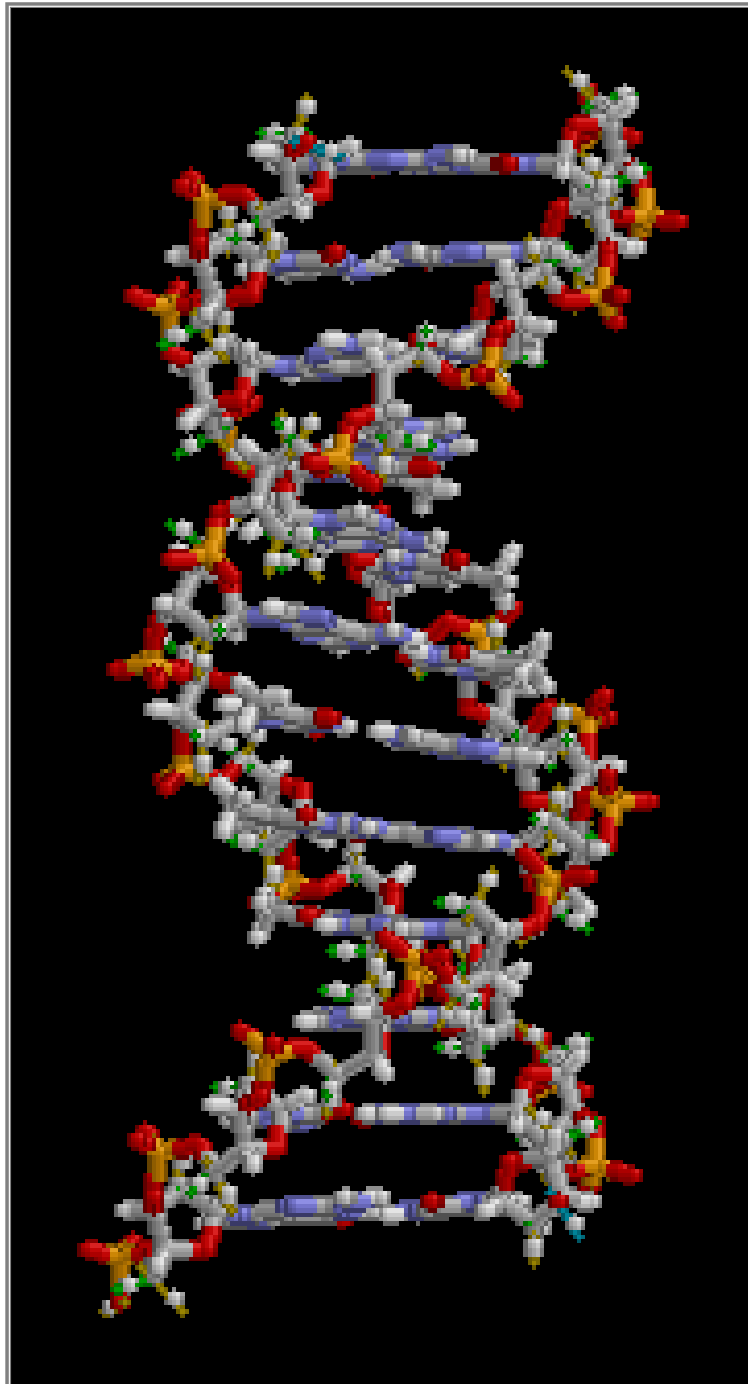

**DOUBLE
HELIX
MODEL**

H-BONDS
IMPART
HELICAL
STRUCTURE

**DOUBLE
HELIX
MODEL**





DNA NUCLEOTIDES



DNA NUCLEOTIDE BASE PAIRS

DNA DOUBLE HELIX MODEL

A

NUCLEOTIDE BASE PAIRS
PARALLEL POLYNUCLEOTIDE CHAIN

NUCLEOTIDE BASE PAIRS
PARALLEL POLYNUCLEOTIDE CHAIN

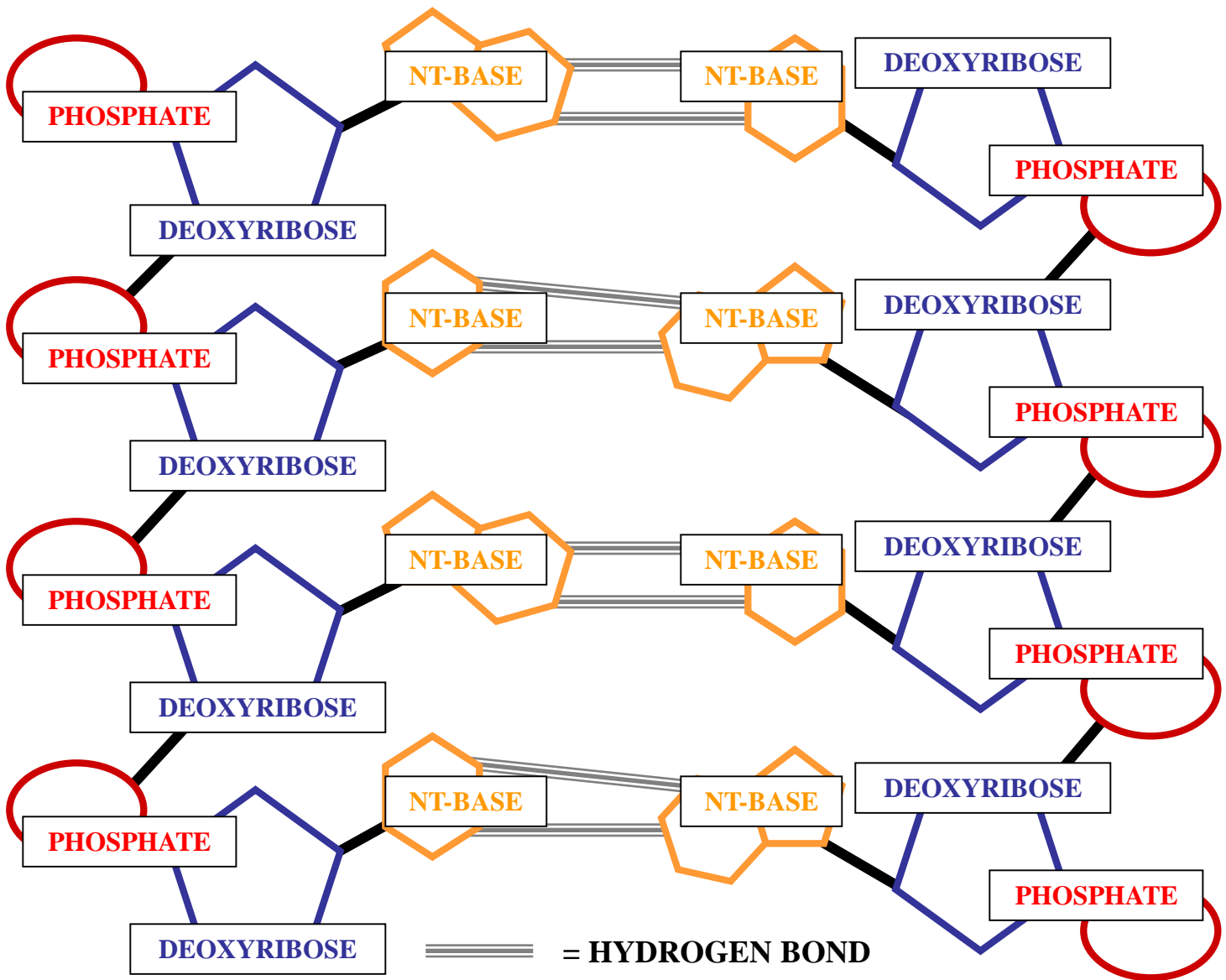

FIRST
POLYNUCLEOTIDE
CHAIN

SECOND
POLYNUCLEOTIDE
CHAIN

== = HYDROGEN BOND

DNA DOUBLE HELIX MODEL

NUCLEOTIDE BASE PAIRS
PARALLEL POLYNUCLEOTIDE CHAIN

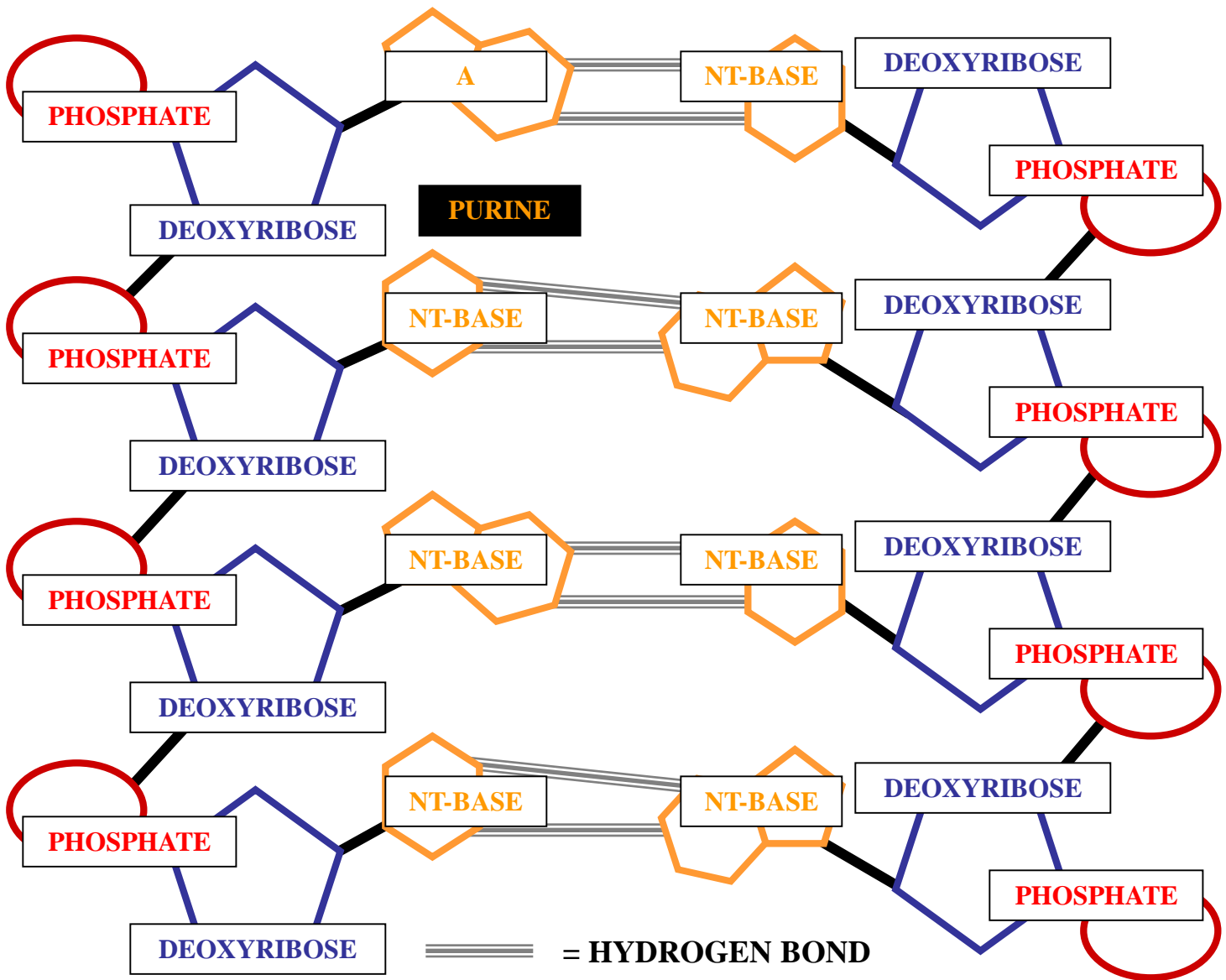

FIRST
POLYNUCLEOTIDE
CHAIN

SECOND
POLYNUCLEOTIDE
CHAIN

== = HYDROGEN BOND

NUCLEOTIDE BASE PAIRS
PARALLEL POLYNUCLEOTIDE CHAIN

T

DNA DOUBLE HELIX MODEL

G

NUCLEOTIDE BASE PAIRS
PARALLEL POLYNUCLEOTIDE CHAIN

NUCLEOTIDE BASE PAIRS
PARALLEL POLYNUCLEOTIDE CHAIN

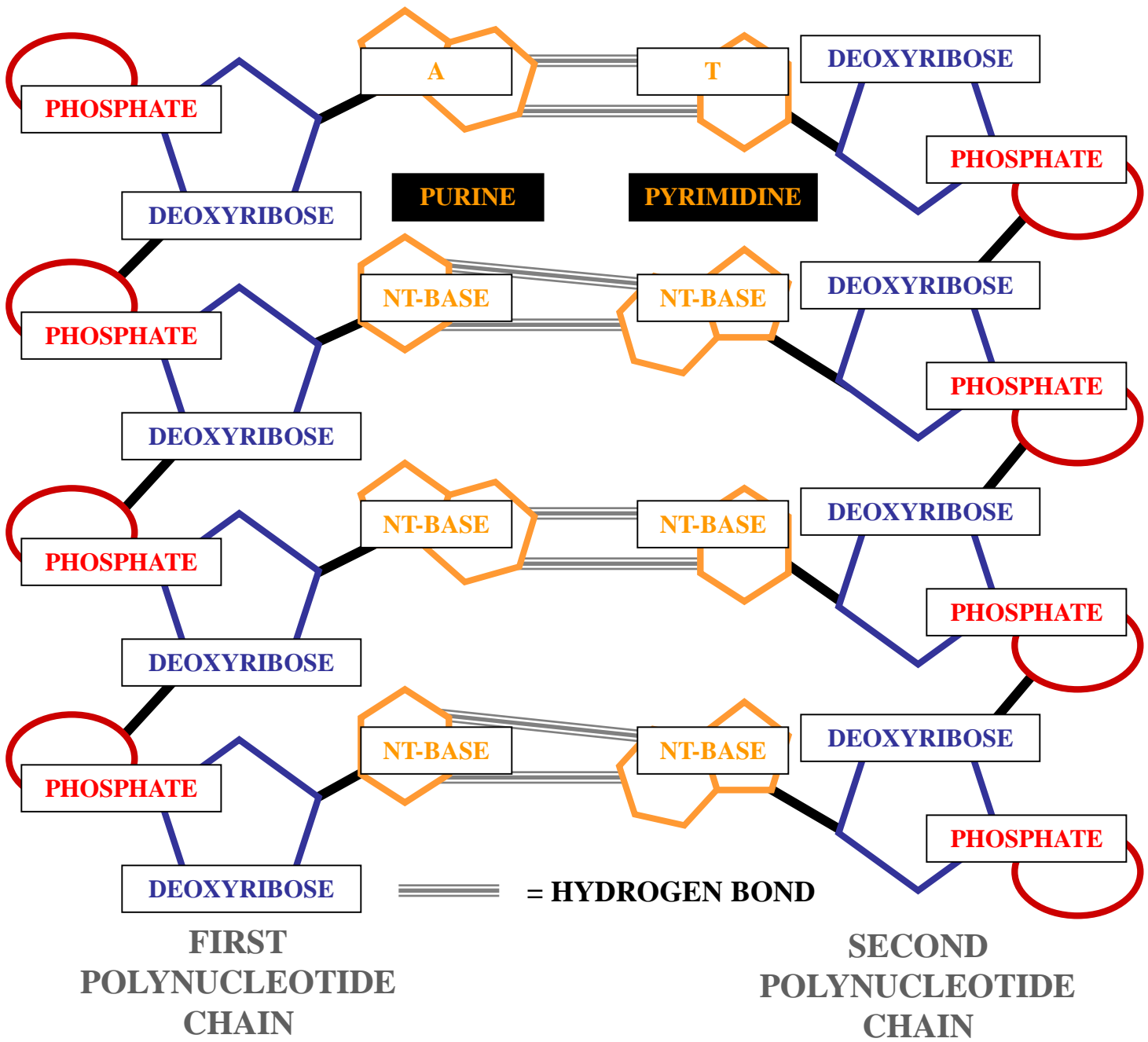

FIRST
POLYNUCLEOTIDE
CHAIN

SECOND
POLYNUCLEOTIDE
CHAIN

DNA DOUBLE HELIX MODEL

NUCLEOTIDE BASE PAIRS
PARALLEL POLYNUCLEOTIDE CHAIN

NUCLEOTIDE BASE PAIRS
PARALLEL POLYNUCLEOTIDE CHAIN

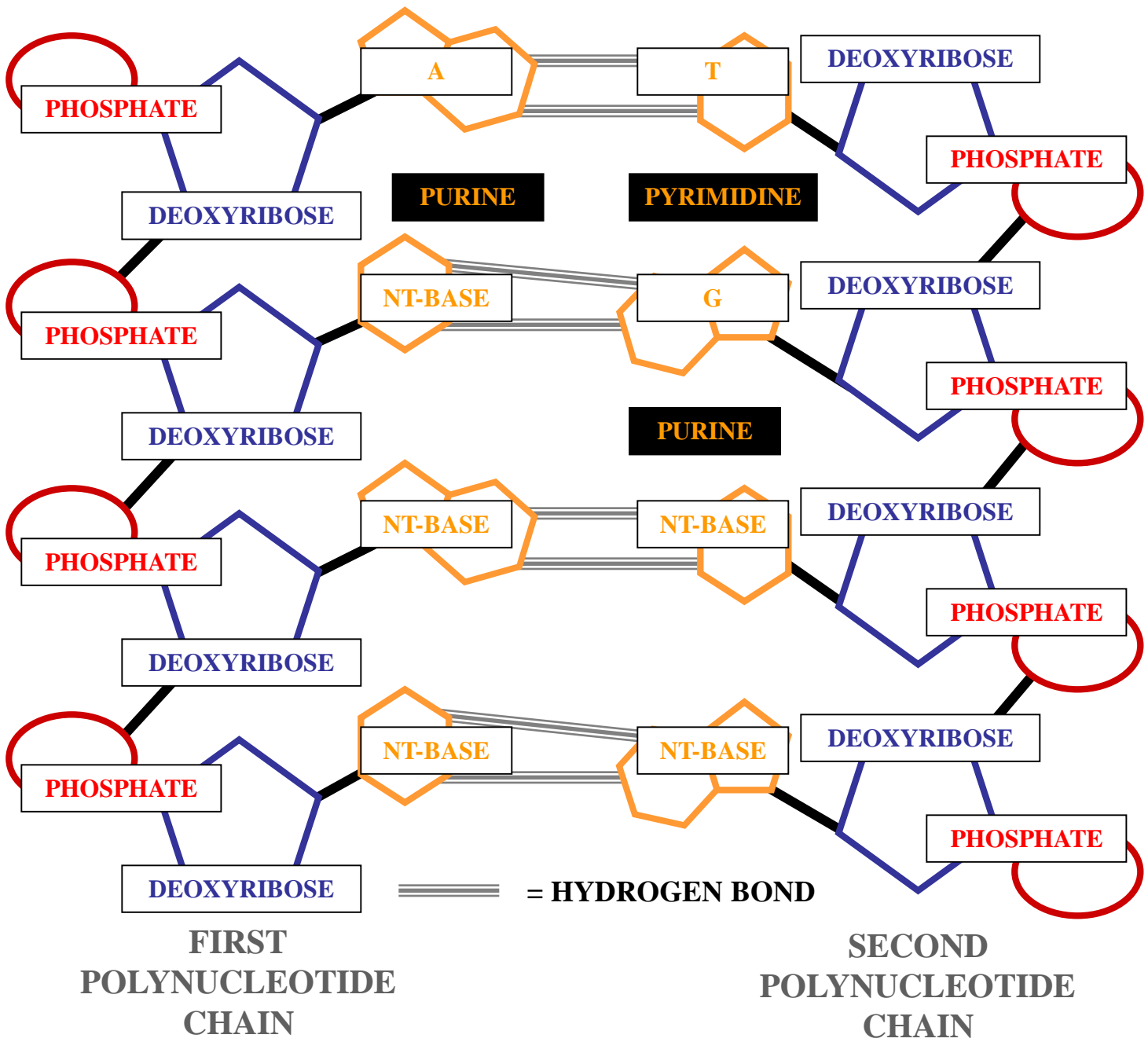

DNA DOUBLE HELIX MODEL

NUCLEOTIDE BASE PAIRS
PARALLEL POLYNUCLEOTIDE CHAIN

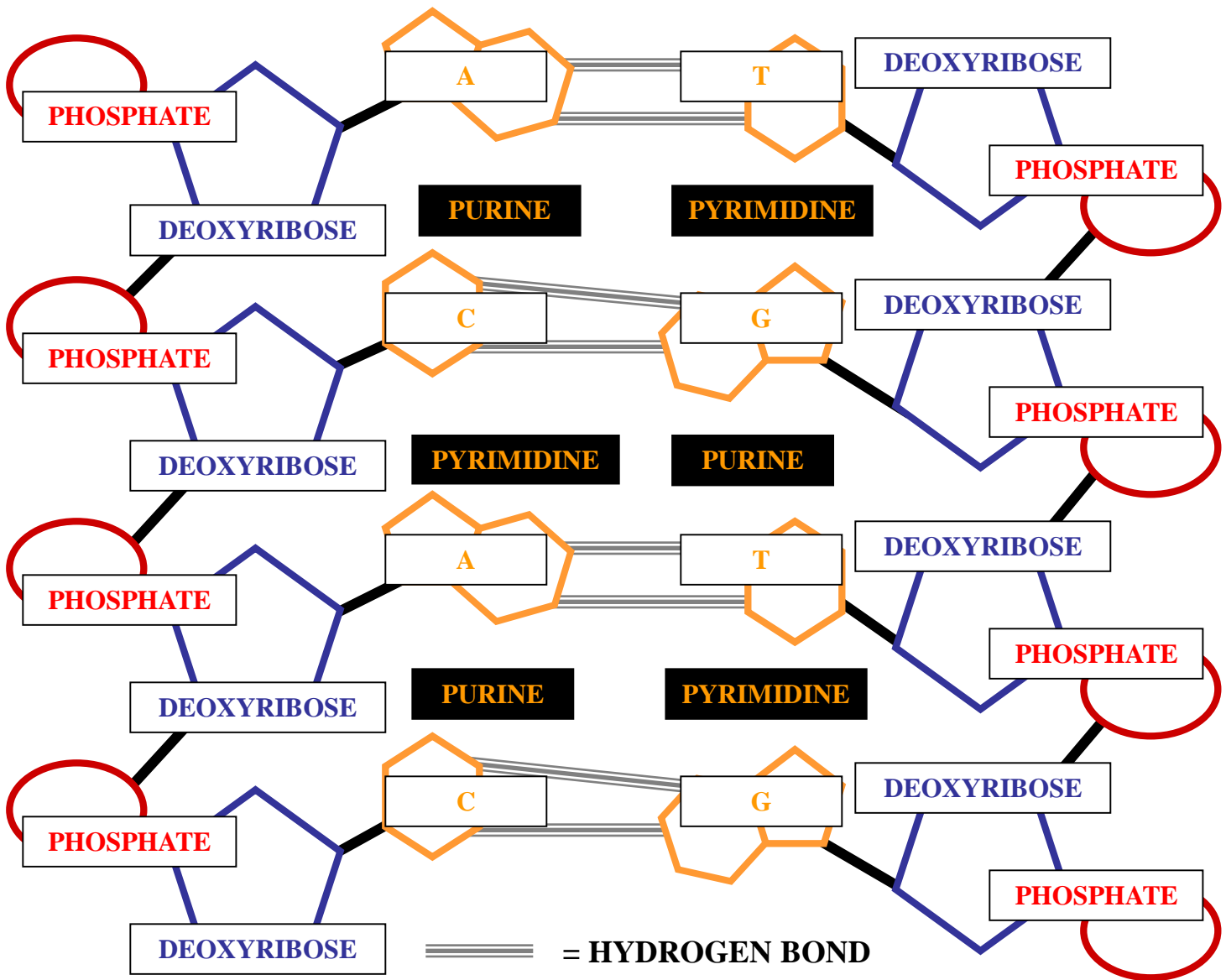

FIRST
POLYNUCLEOTIDE
CHAIN

SECOND
POLYNUCLEOTIDE
CHAIN

== = HYDROGEN BOND

NUCLEOTIDE BASE PAIRS
PARALLEL POLYNUCLEOTIDE CHAIN



NUCLEOTIDE BASE PAIRS
PARALLEL POLYNUCLEOTIDE CHAIN

DNA DEOXYRIBONUCLEIC ACID STRUCTURE

**PURINES
PAIR WITH
PYRIMIDINES**



DNA DEOXYRIBONUCLEIC ACID STRUCTURE

**DOUBLE
HELIX
MODEL**

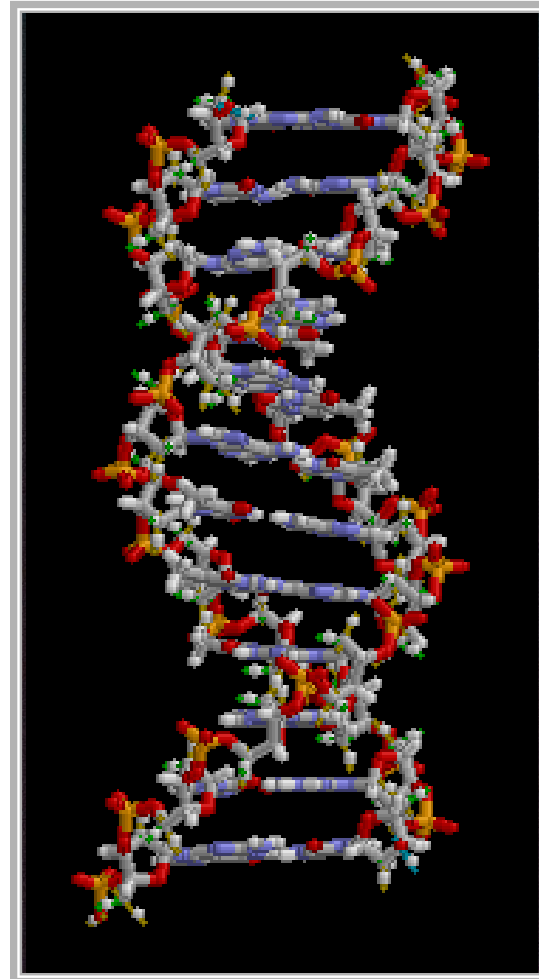

**DOUBLE
HELIX
MODEL**



RNA STRUCTURE

RNA NUCLEOTIDES



RNA
NUCLEOTIDE
SUGAR

DNA NUCLEOTIDE

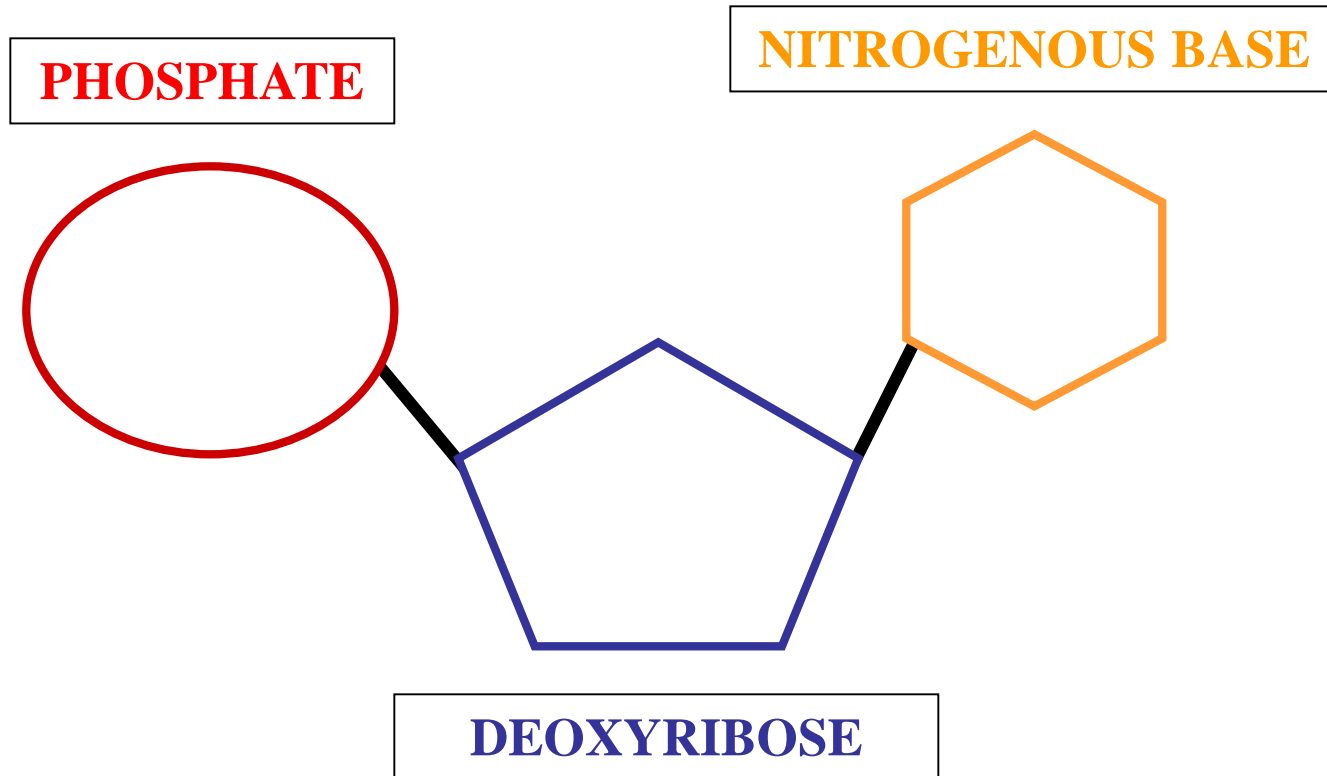
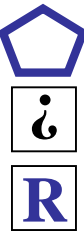

RNA NUCLEOTIDE

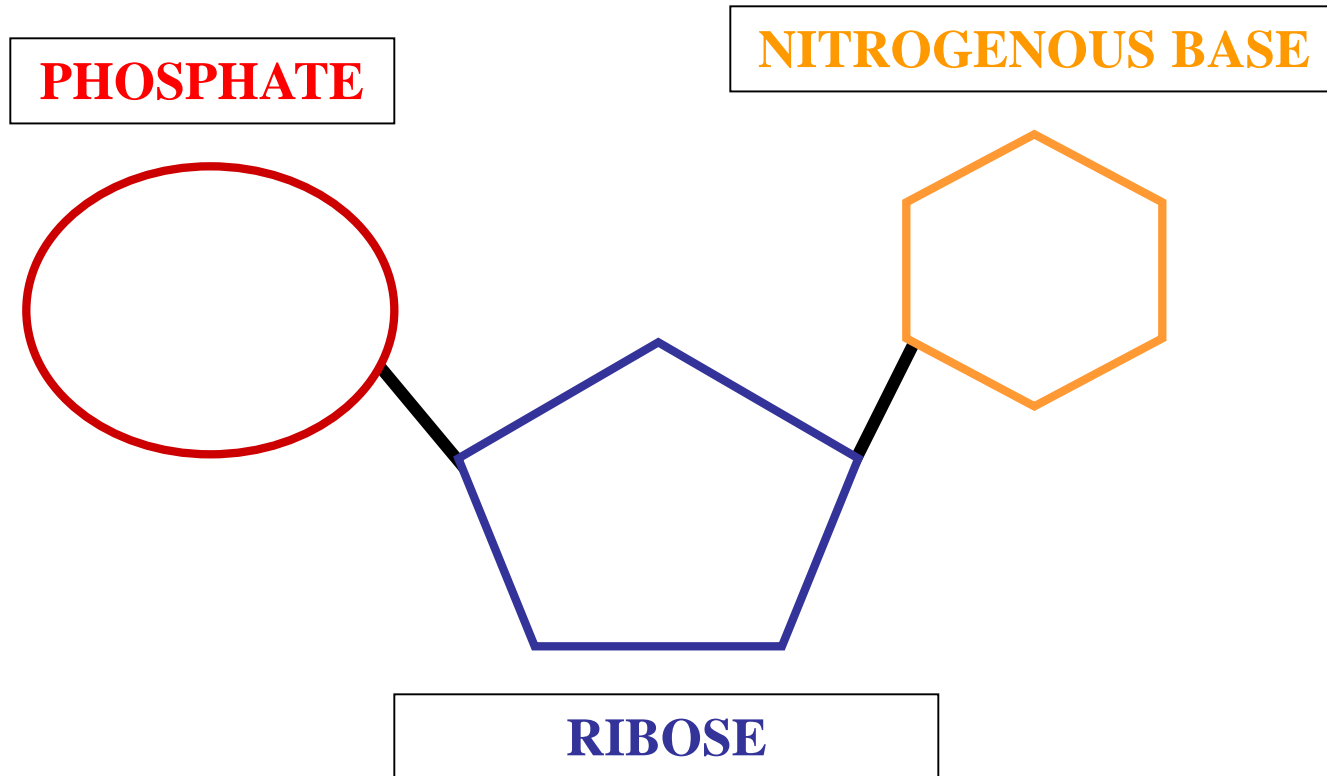



RNA NUCLEOTIDE BASES