

VO

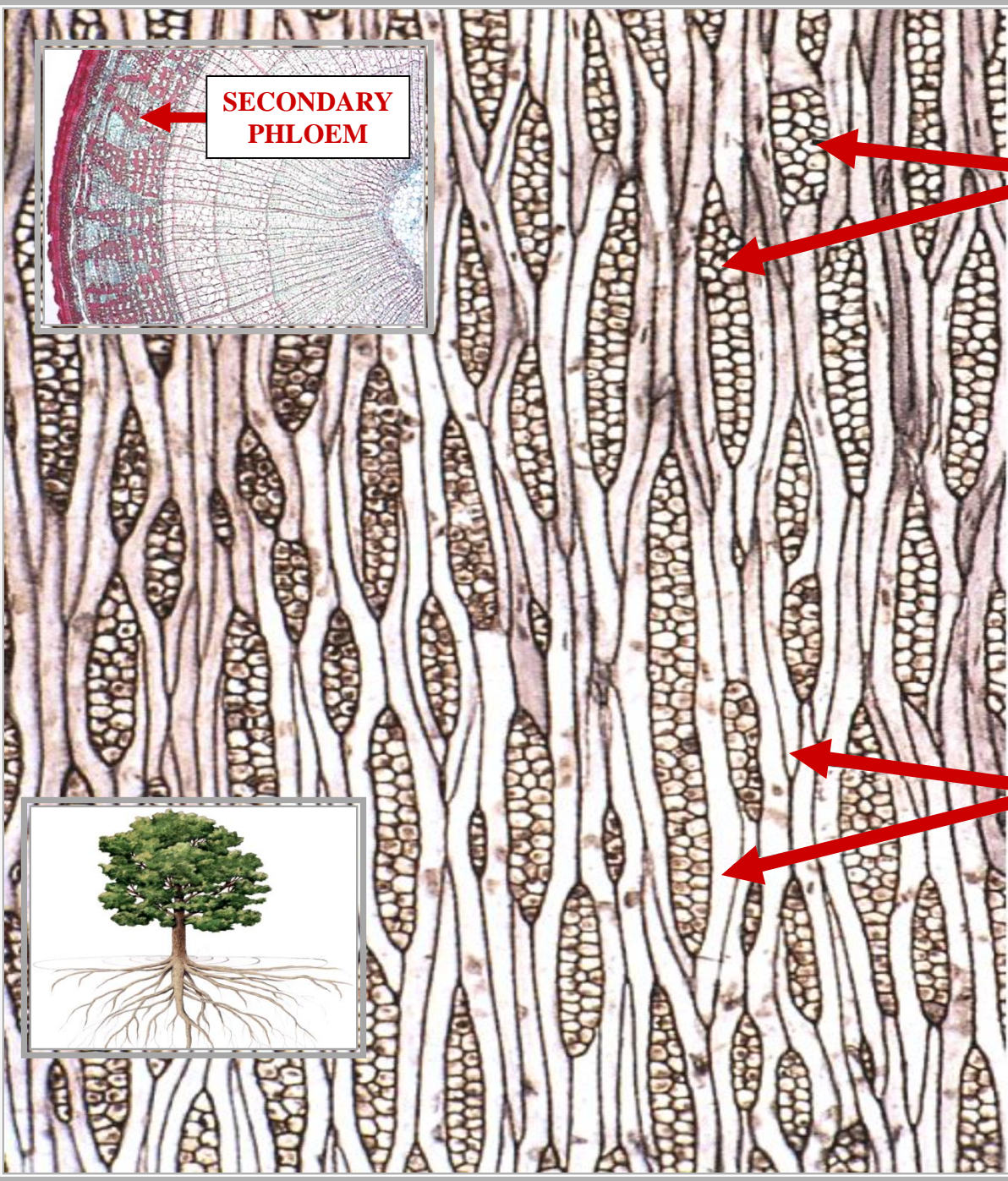
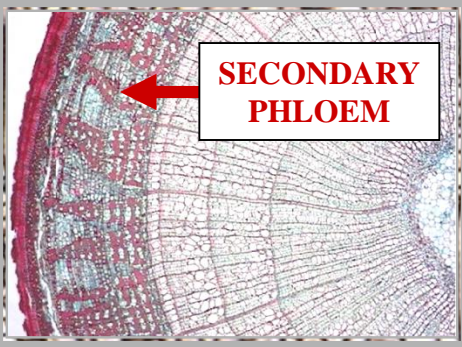

**AXIAL
PARENCHYMA**

~2 PHLOEM TISSUE

DICOT ~2 STEM

L.S.

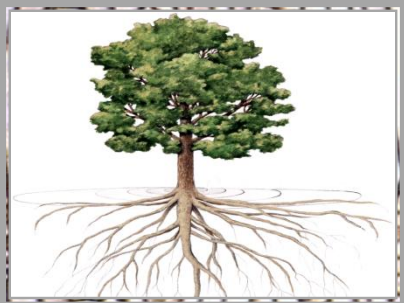

VT

**SECONDARY
PHLOEM**



**VERTICAL
ORIENTATION**

~2 PHLOEM TISSUE

DICOT ~2 STEM

L.S.

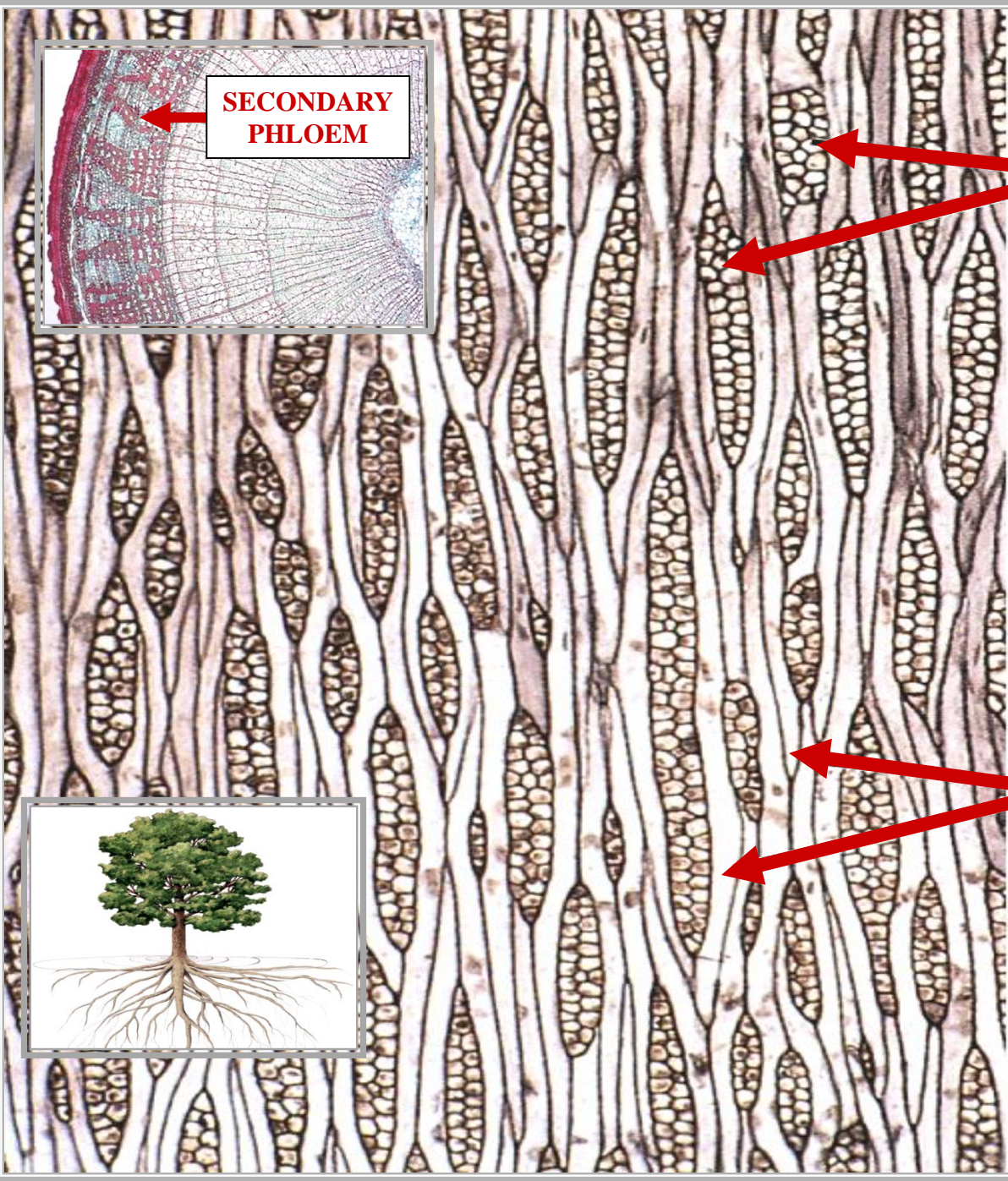
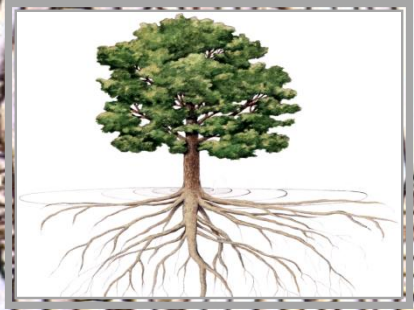
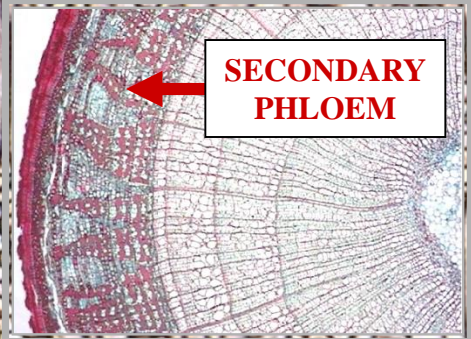

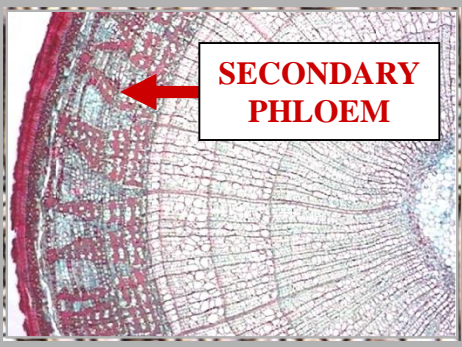
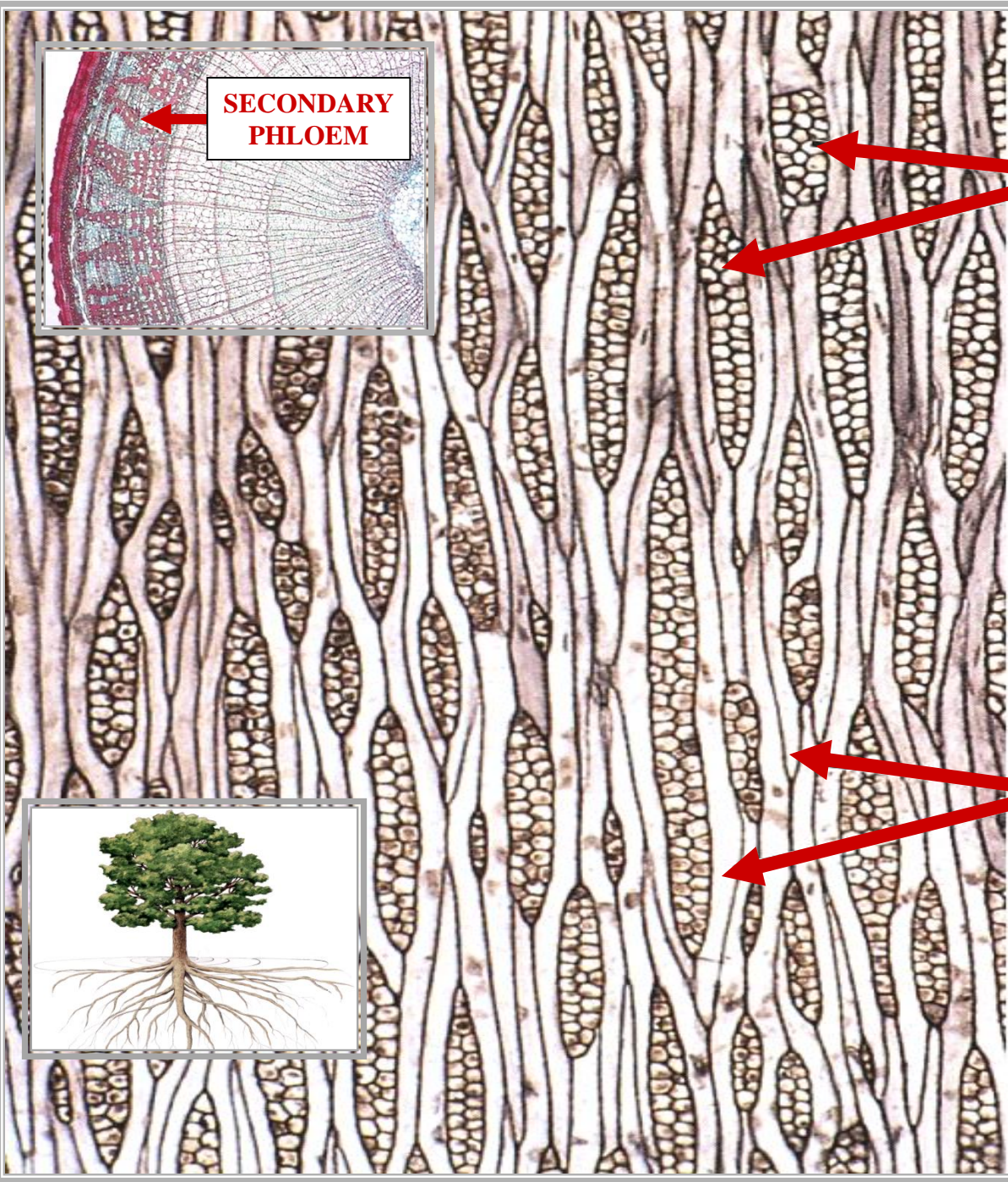

**SECONDARY
PHLOEM**

VC **FI**



**VERTICAL
TRANSPORT**

~2 PHLOEM TISSUE

DICOT ~2 STEM

L.S.

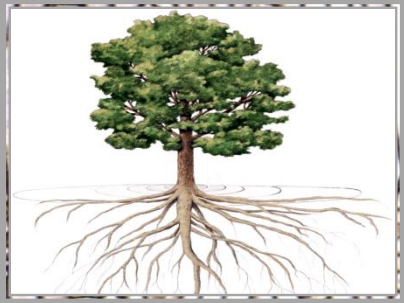

+

AP

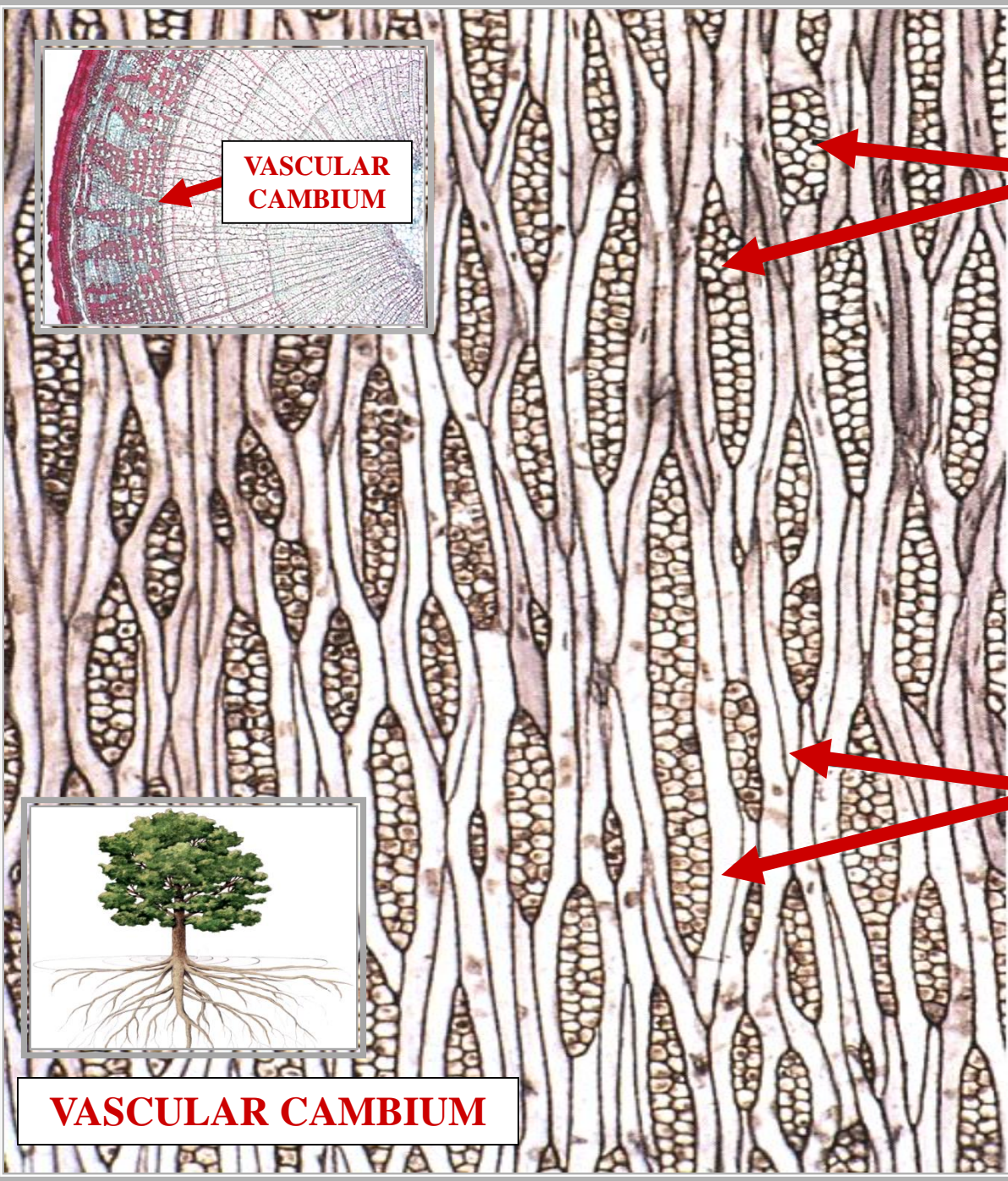
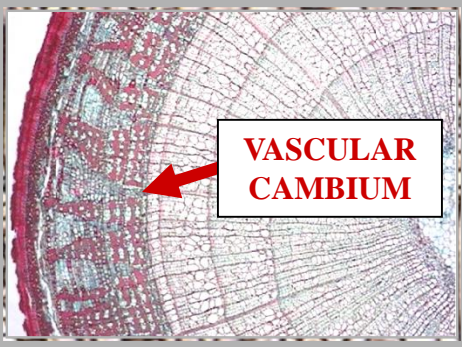

**FUSIFORM
INITIAL
DERIVED**

~2 PHLOEM TISSUE

DICOT ~2 STEM

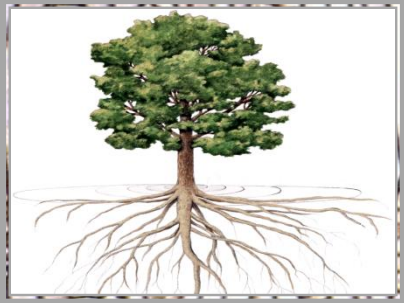

VASCULAR CAMBIUM

L.S.

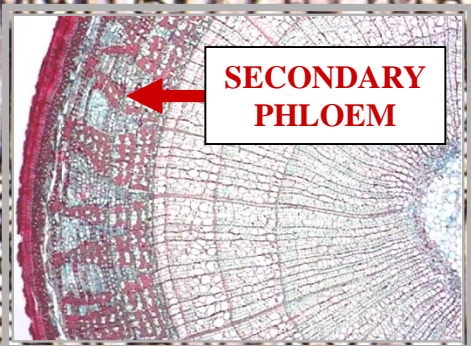

**SECONDARY
PHLOEM**

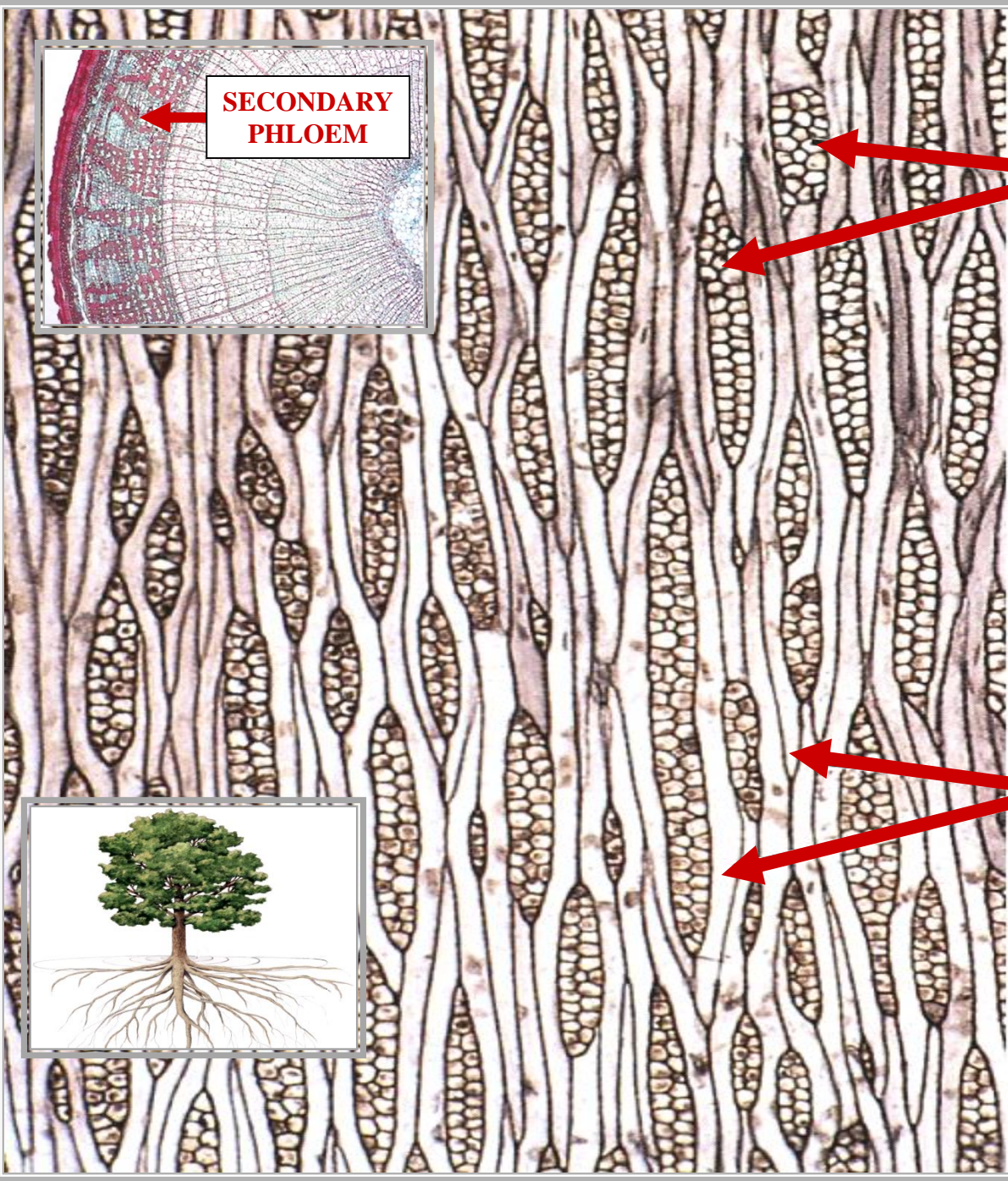

**AXIAL
PARENCHYMA**

~2 PHLOEM TISSUE

DICOT ~2 STEM

L.S.

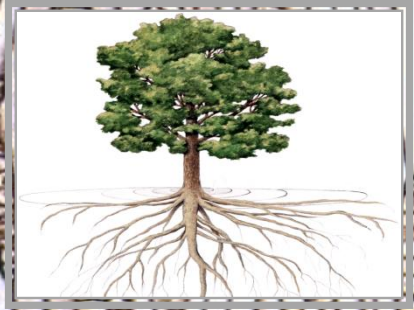

**AXIAL
PARENCHYMA
CELL TYPES**

**SECONDARY PHLOEM
AXIAL PARENCHYMA
CELL TYPES**

COMPANION CELLS

**SECONDARY PHLOEM
AXIAL PARENCHYMA
CELL TYPES**

COMPANION CELL

**SECONDARY PHLOEM
AXIAL PARENCHYMA
COMPANION CELL**



**CONTROLS
SIEVE MEMBER
METABOLISM**

**SECONDARY PHLOEM
AXIAL PARENCHYMA
COMPANION CELL**

CC

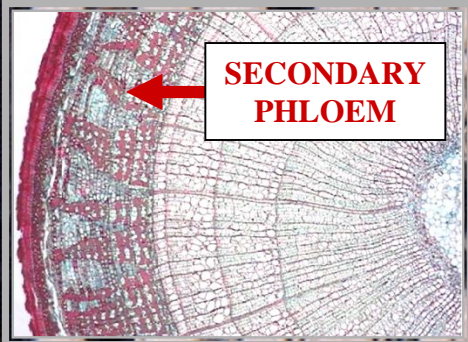

AXIAL PARENCHYMA

DICOT ~2 STEM

~2 PHLOEM TISSUE

L.S.

SIEVE MEMBERS

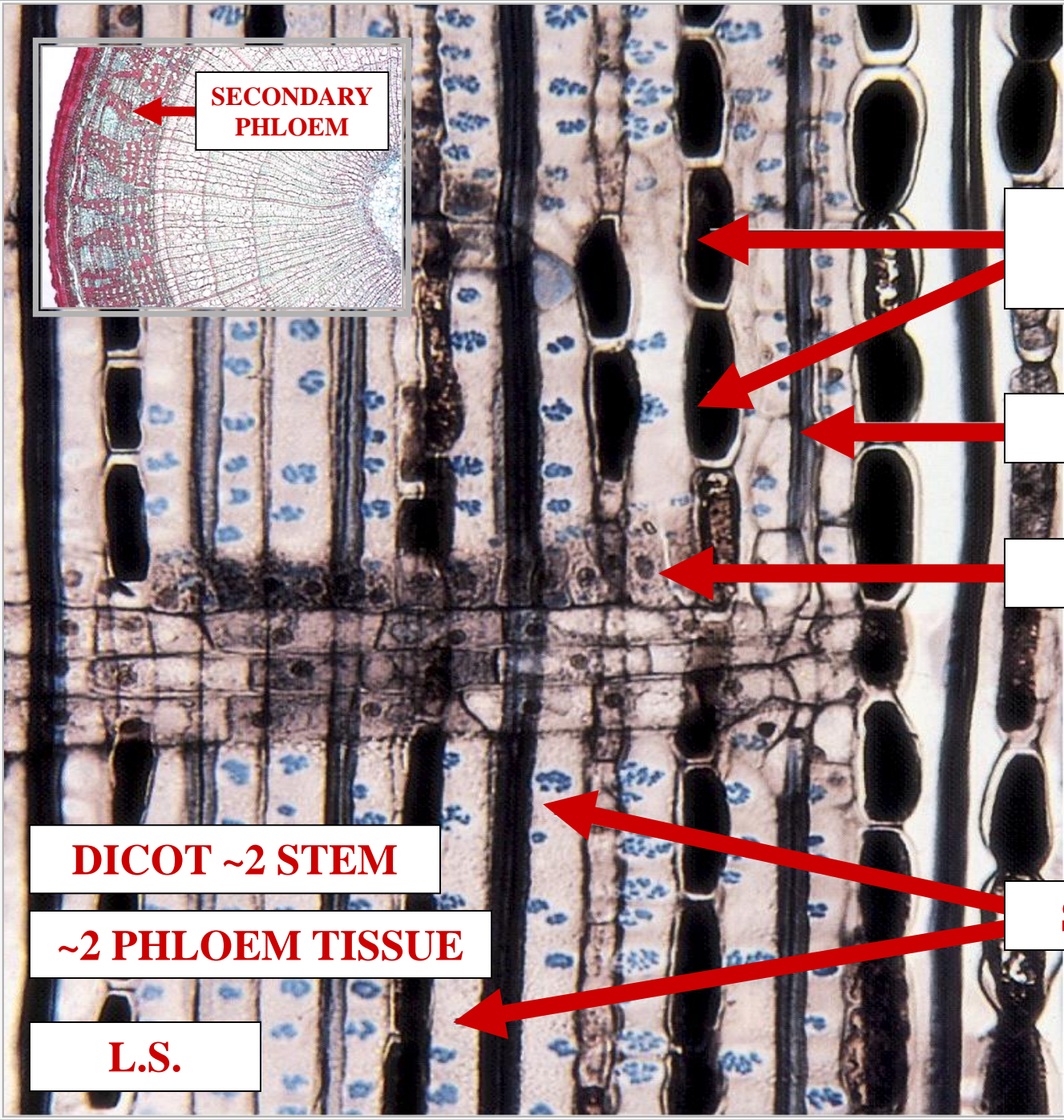

CS

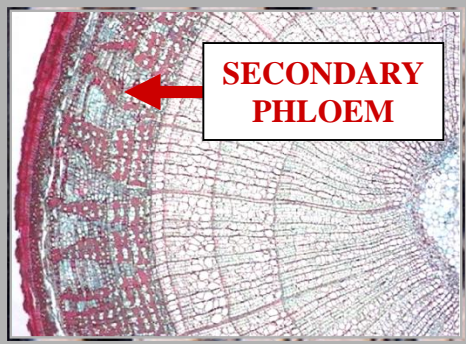

COMPANION CELLS

DICOT ~2 STEM

~2 PHLOEM TISSUE

L.S.

SIEVE MEMBERS

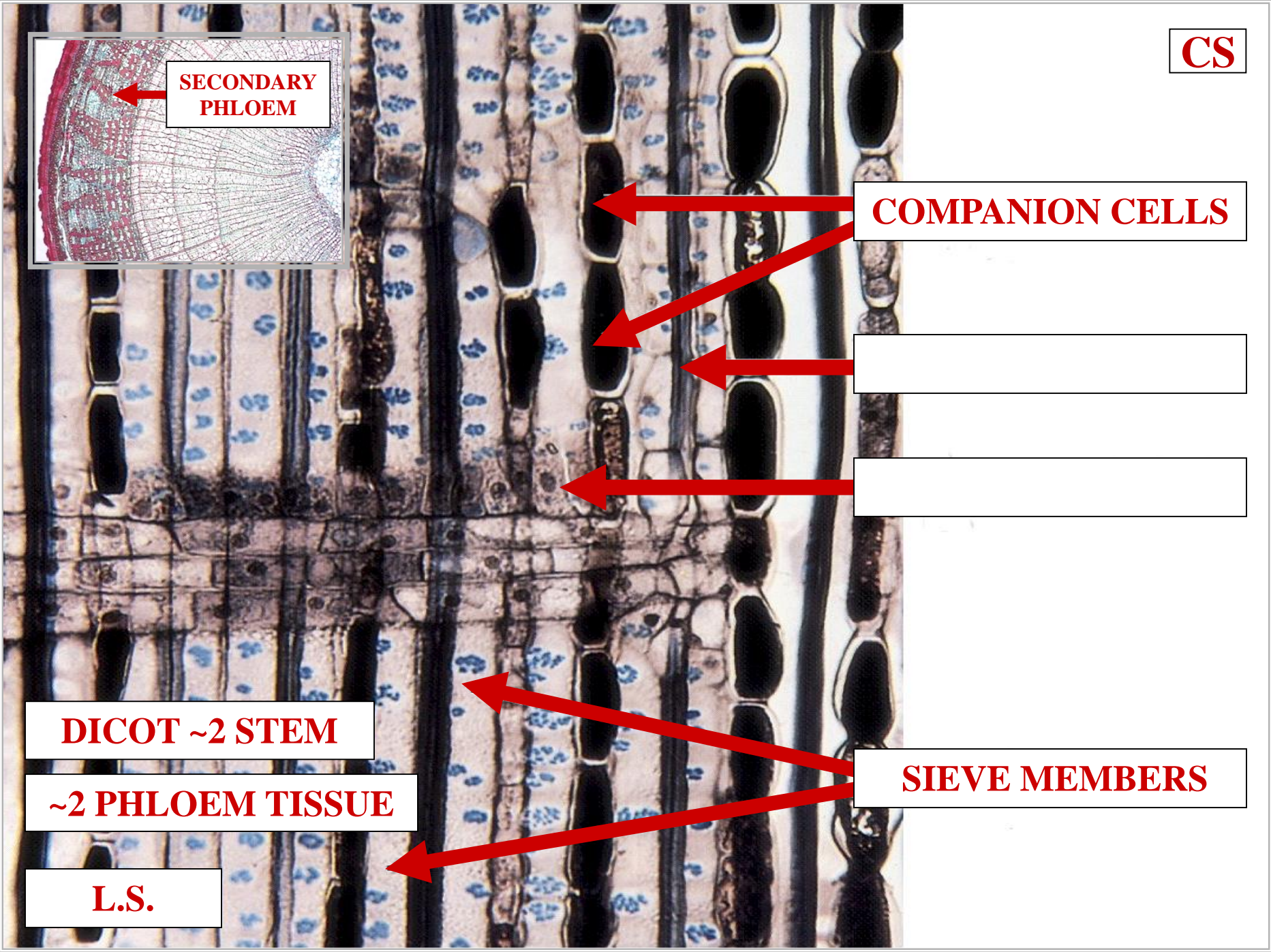

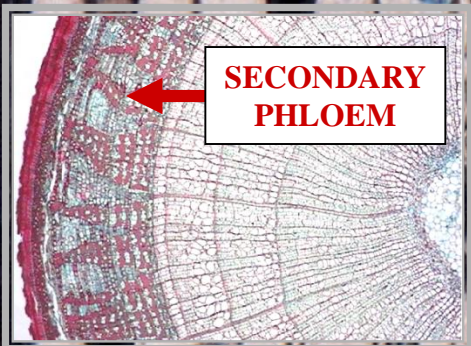

**SECONDARY
PHLOEM**

**COMPANION CELLS
CONTROL
SIEVE MEMBER
METABOLISM**

DICOT ~2 STEM

~2 PHLOEM TISSUE

L.S.

SIEVE MEMBERS

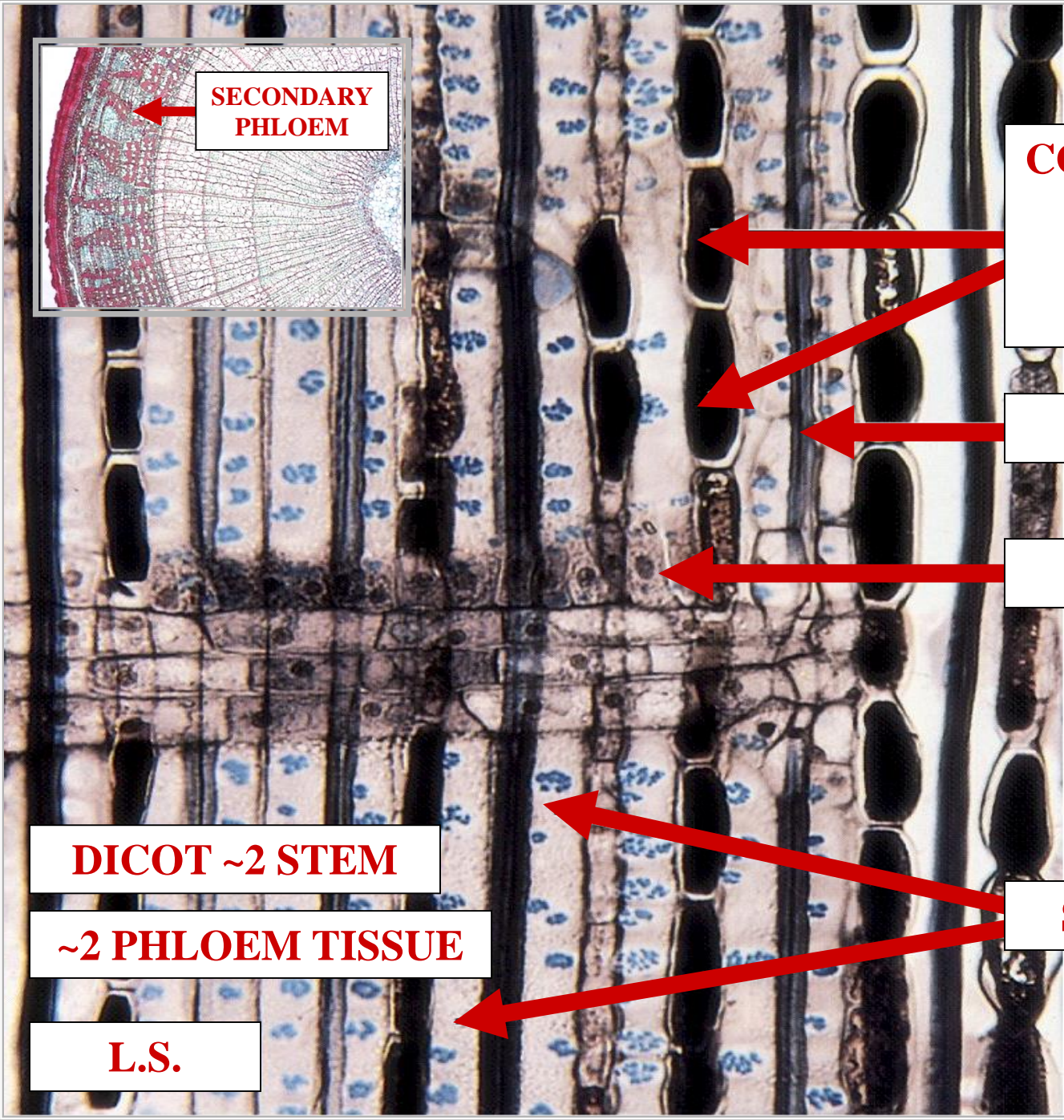

**SECONDARY
PHILOEM TISSUE
RAY
PARENCHYMA**

RAY

PARENCHYMA



**SECONDARY PHLOEM
AXIAL PARENCHYMA
RAY PARENCHYMA**

LATERAL ORIENTATION

**SECONDARY PHLOEM
AXIAL PARENCHYMA
RAY PARENCHYMA**



**SECONDARY PHLOEM
AXIAL PARENCHYMA
RAY PARENCHYMA**

LATERAL ORIENTATION

LATERAL TRANSPORT

**SECONDARY PHLOEM
AXIAL PARENCHYMA
RAY PARENCHYMA**

**SECONDARY PHLOEM
AXIAL PARENCHYMA
RAY PARENCHYMA
LATERAL ORIENTATION**

LATERAL TRANSPORT

RAY INITIAL DERIVED

**SECONDARY PHLOEM
AXIAL PARENCHYMA
RAY PARENCHYMA**



TS

**RAY
PARENCHYMA
TANGENTIAL
SECTION**

LO

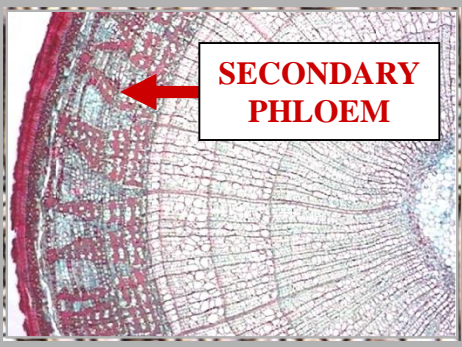

**RAY
PARENCHYMA**

TANGENTIAL SECTION



~2 PHLOEM TISSUE

DICOT ~2 STEM

L.S.

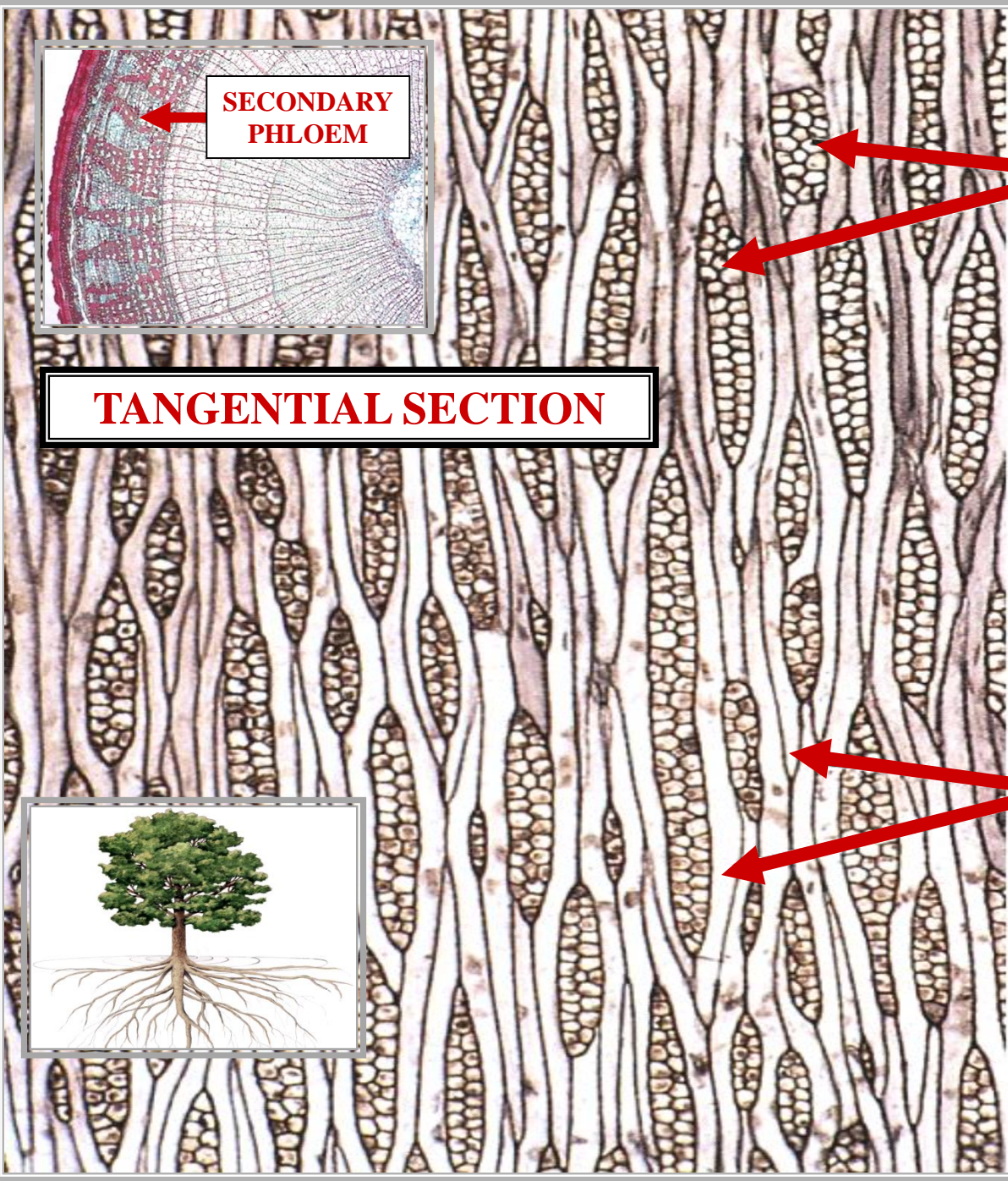
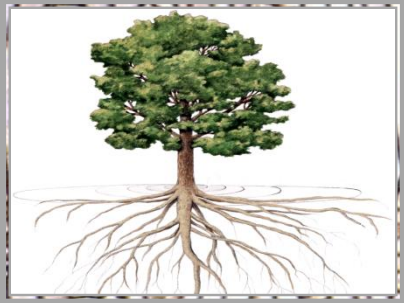

LT

**LATERAL
ORIENTATION**

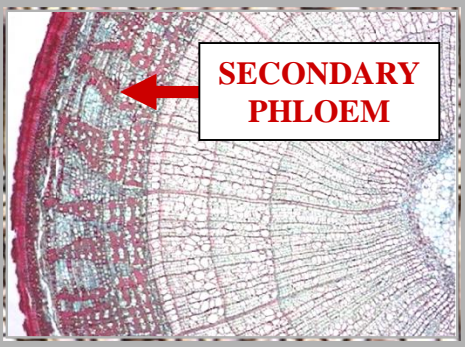

TANGENTIAL SECTION



~2 PHLOEM TISSUE

DICOT ~2 STEM

L.S.

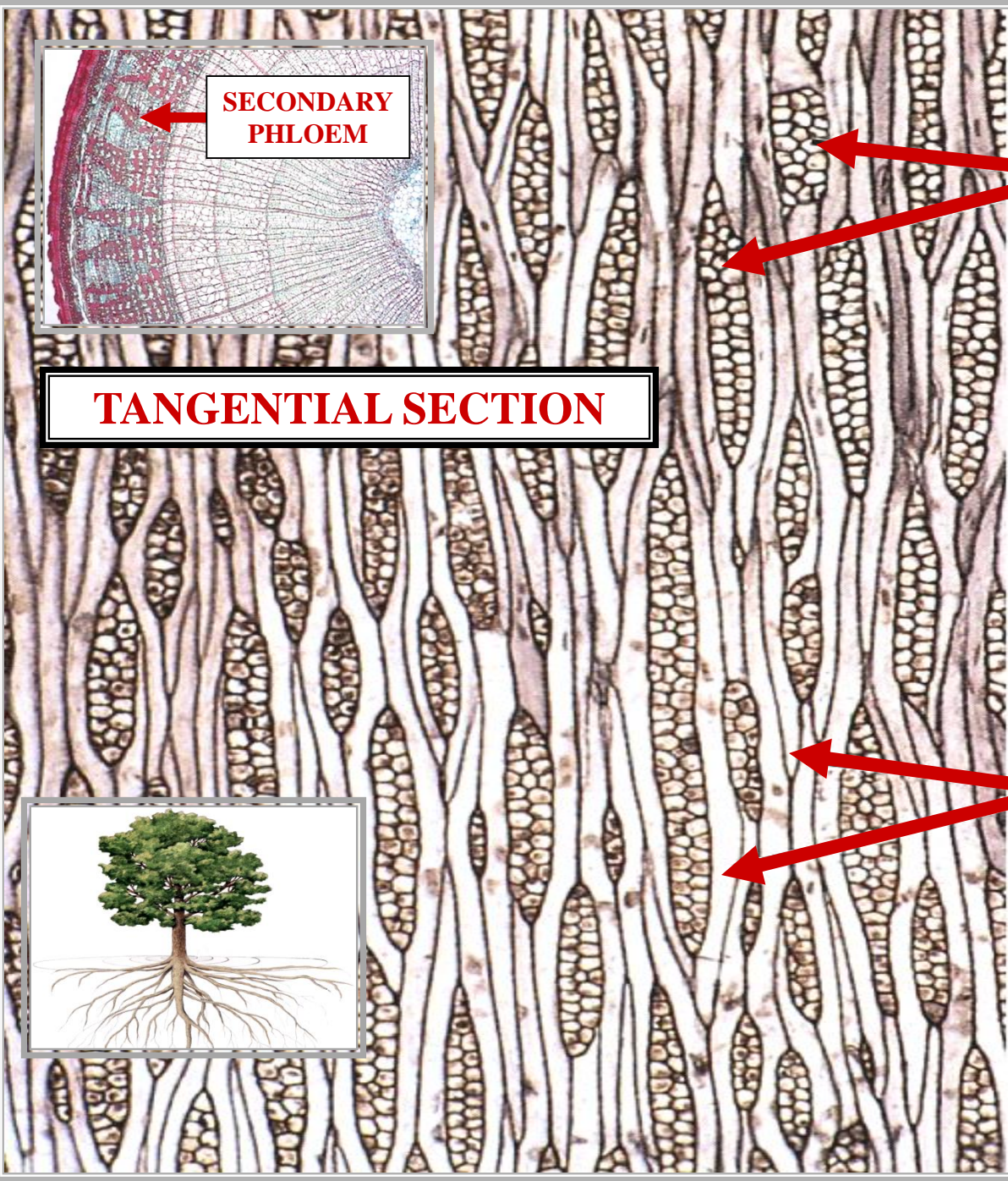
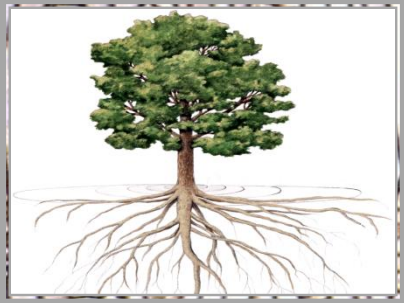

VC RI

LATERAL
TRANSPORT

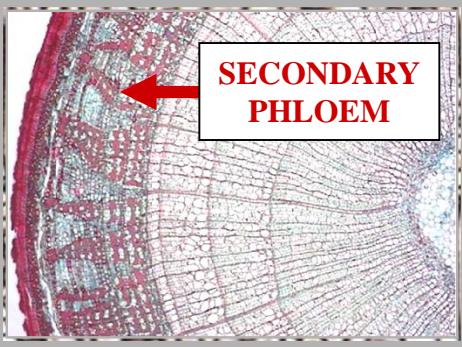

TANGENTIAL SECTION

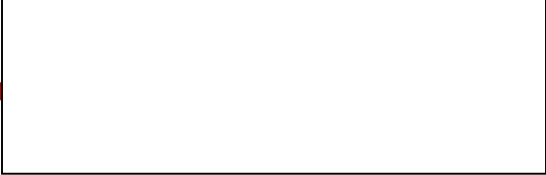
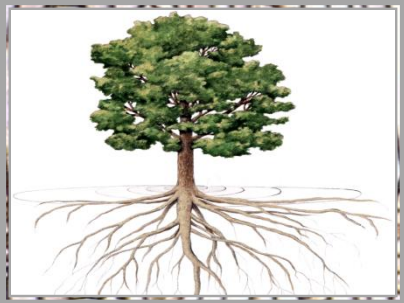

~2 PHLOEM TISSUE

DICOT ~2 STEM

L.S.

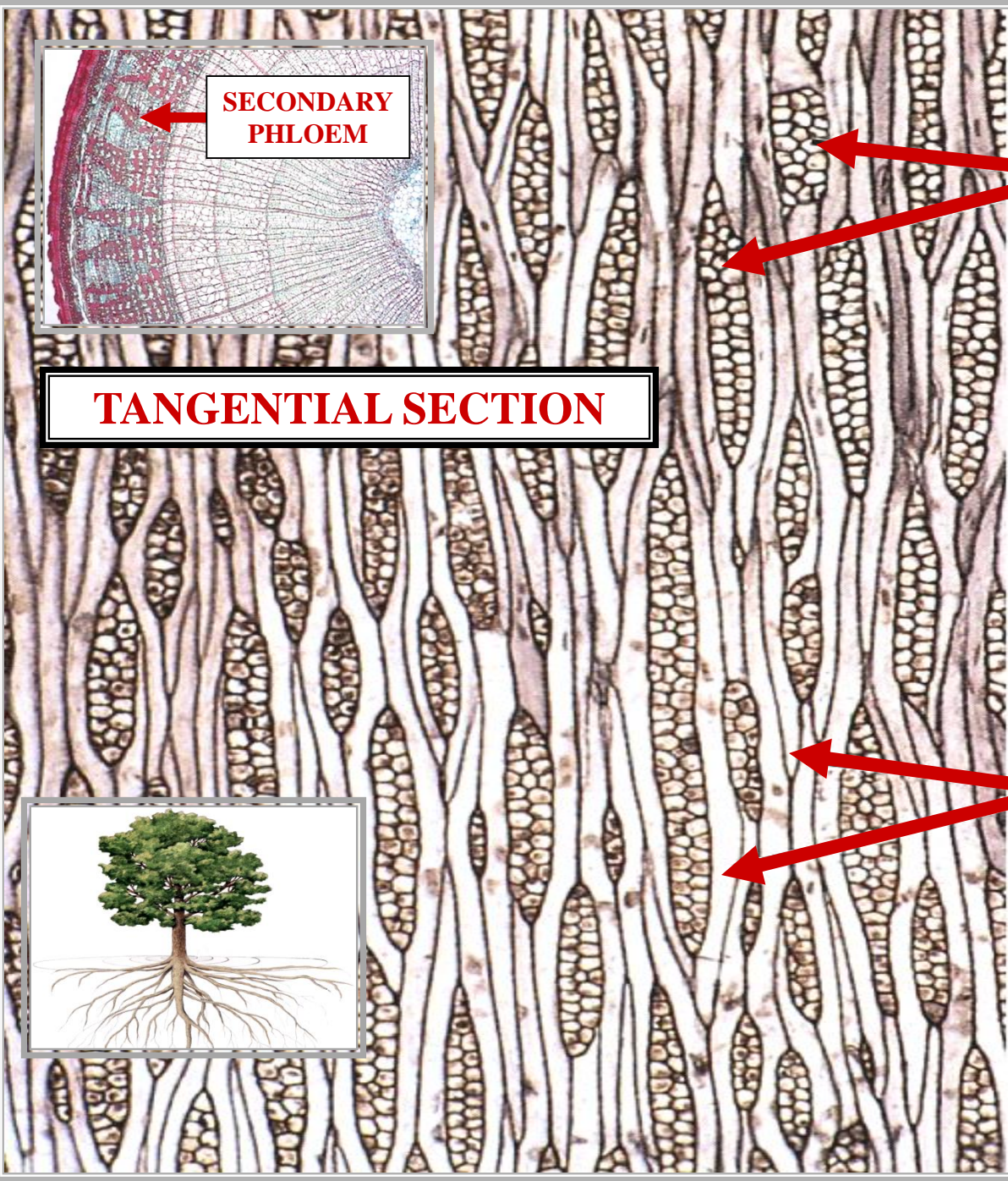

+

RP

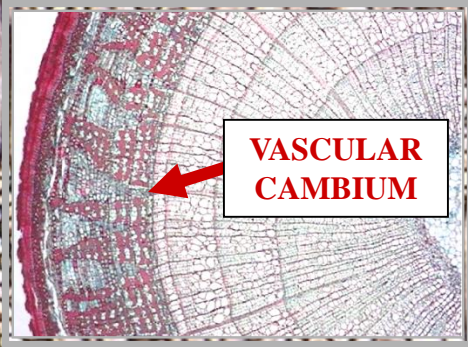

RAY
INITIAL
DERIVED

TANGENTIAL SECTION



~2 PHLOEM TISSUE

DICOT ~2 STEM

L.S.

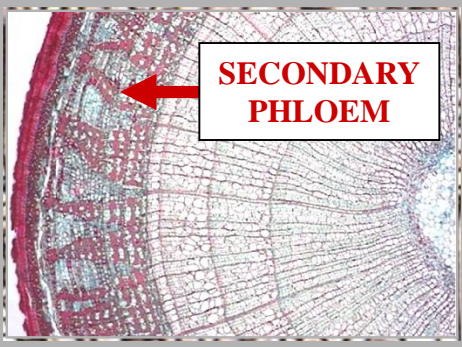

SECONDARY PHLOEM

RAY PARENCHYMA

TANGENTIAL SECTION



~2 PHLOEM TISSUE

DICOT ~2 STEM

L.S.

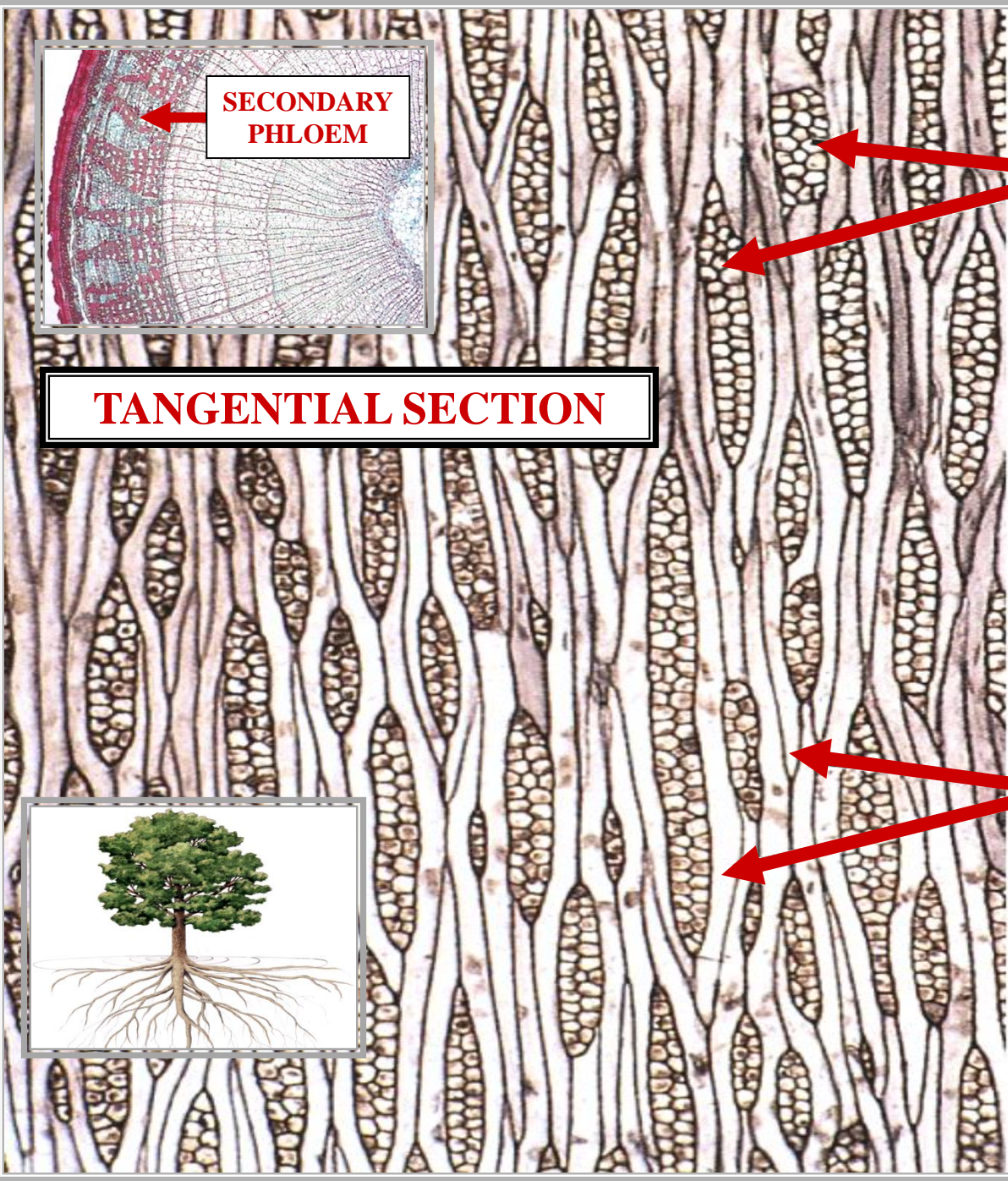
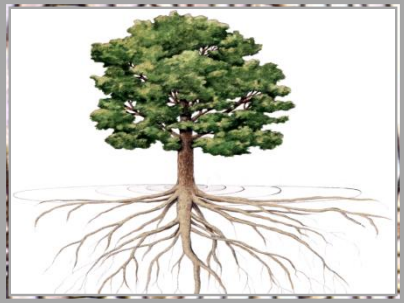

**RAY
PARENCHYMA
RADIAL
SECTION**

LO

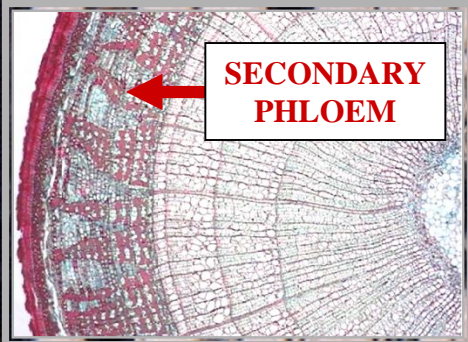

RAY PARENCHYMA



DICOT ~2 STEM

~2 PHLOEM TISSUE

L.S.

RADIAL SECTION

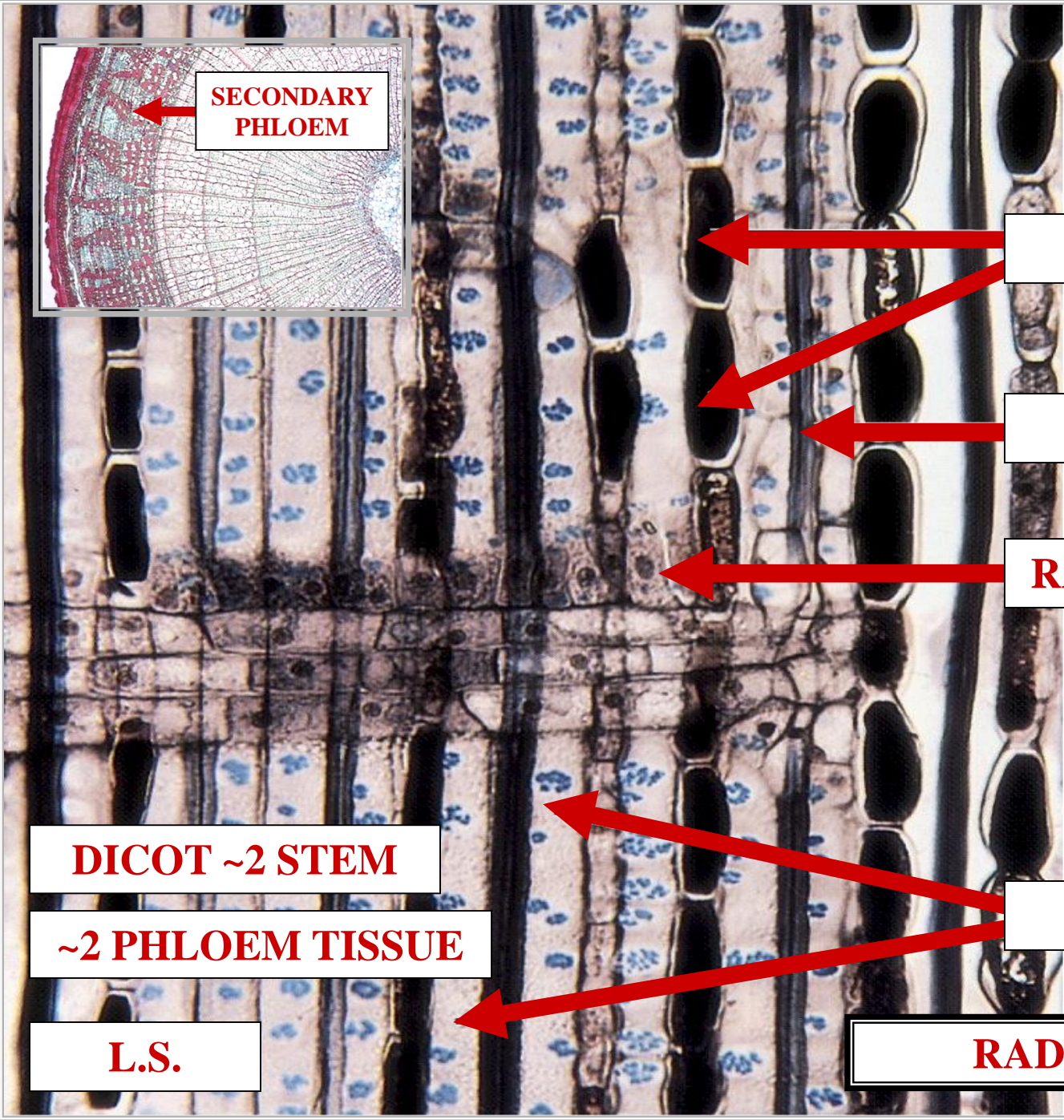

LT

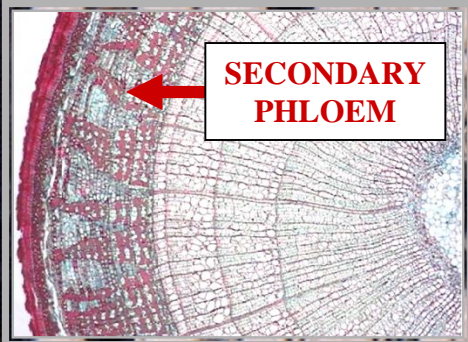

**RAY PARENCHYMA
LATERAL
ORIENTATION**

DICOT ~2 STEM

~2 PHLOEM TISSUE

L.S.

RADIAL SECTION

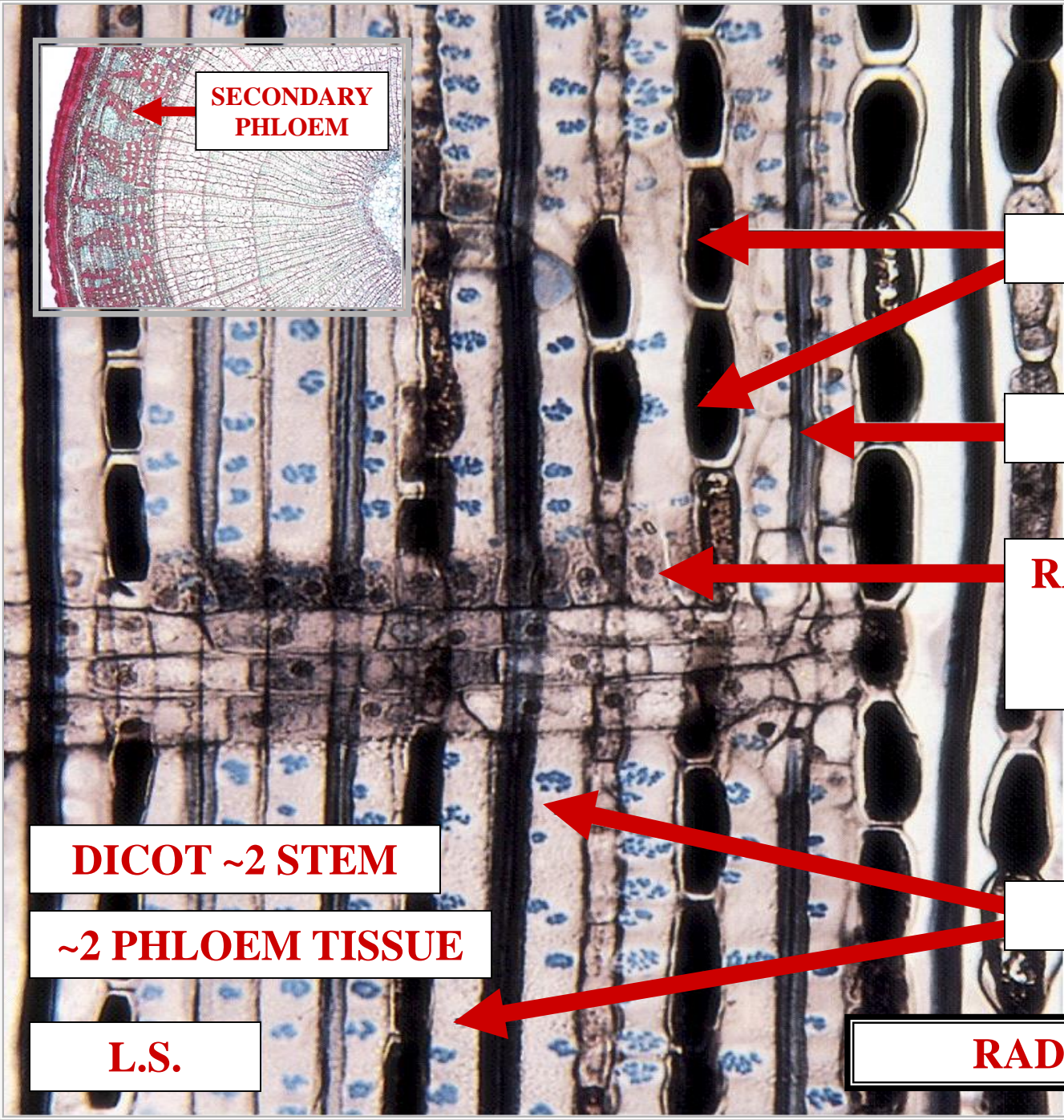

VC **RI**

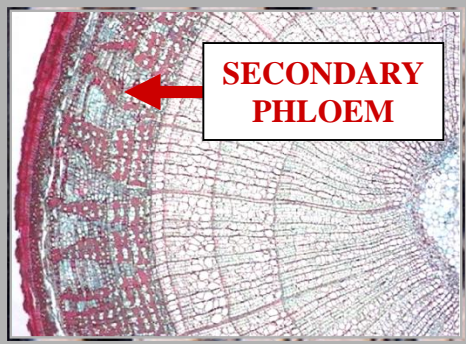

**RAY PARENCHYMA
LATERAL
TRANSPORT**

DICOT ~2 STEM

~2 PHLOEM TISSUE

L.S.



RADIAL SECTION

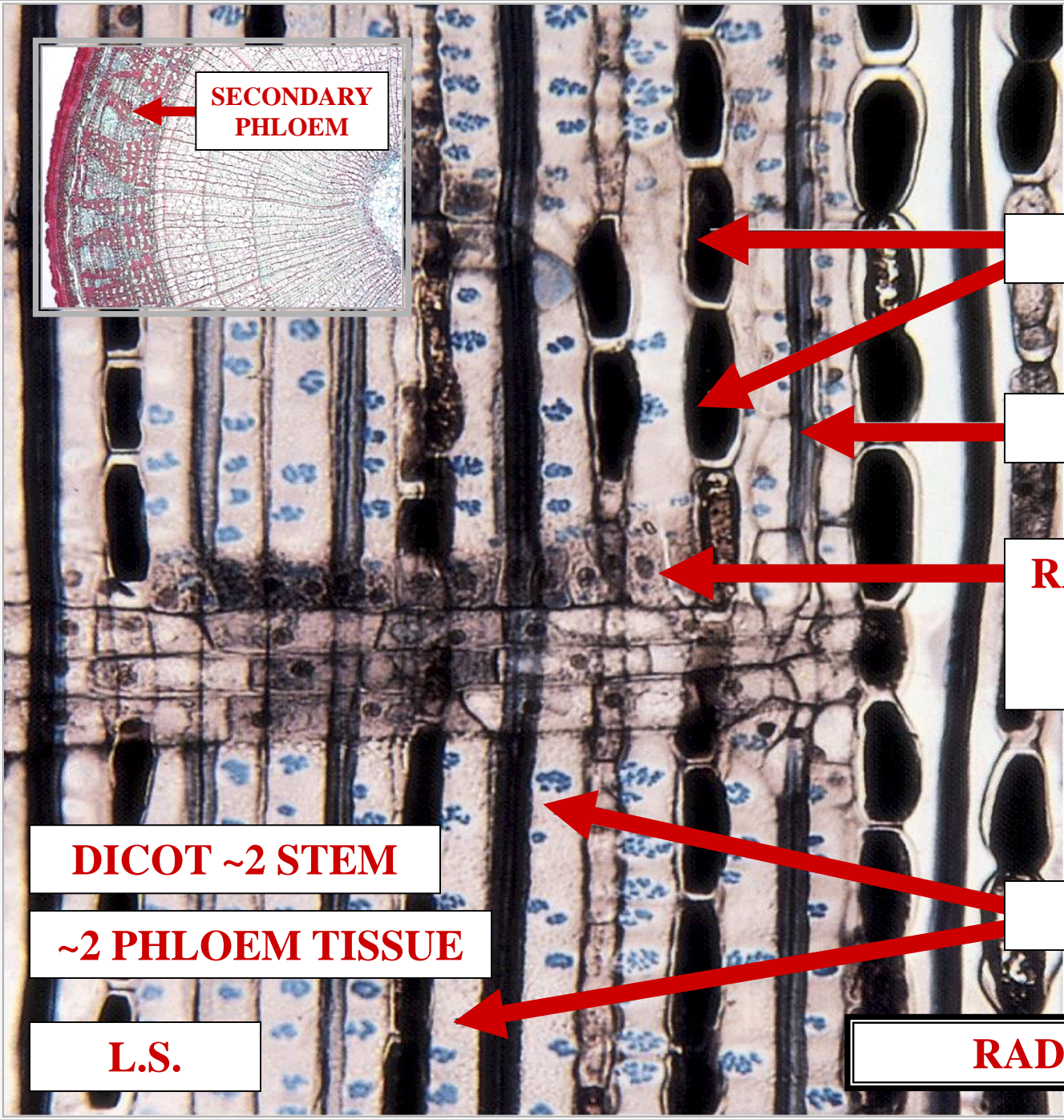

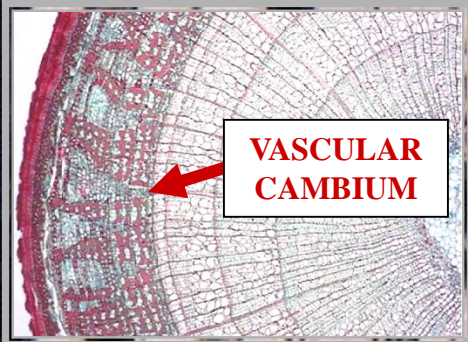

VASCULAR CAMBIUM

RAY PARENCHYMA
RAY INITIAL
DERIVED

DICOT ~2 STEM

~2 PHLOEM TISSUE

L.S.

RADIAL SECTION

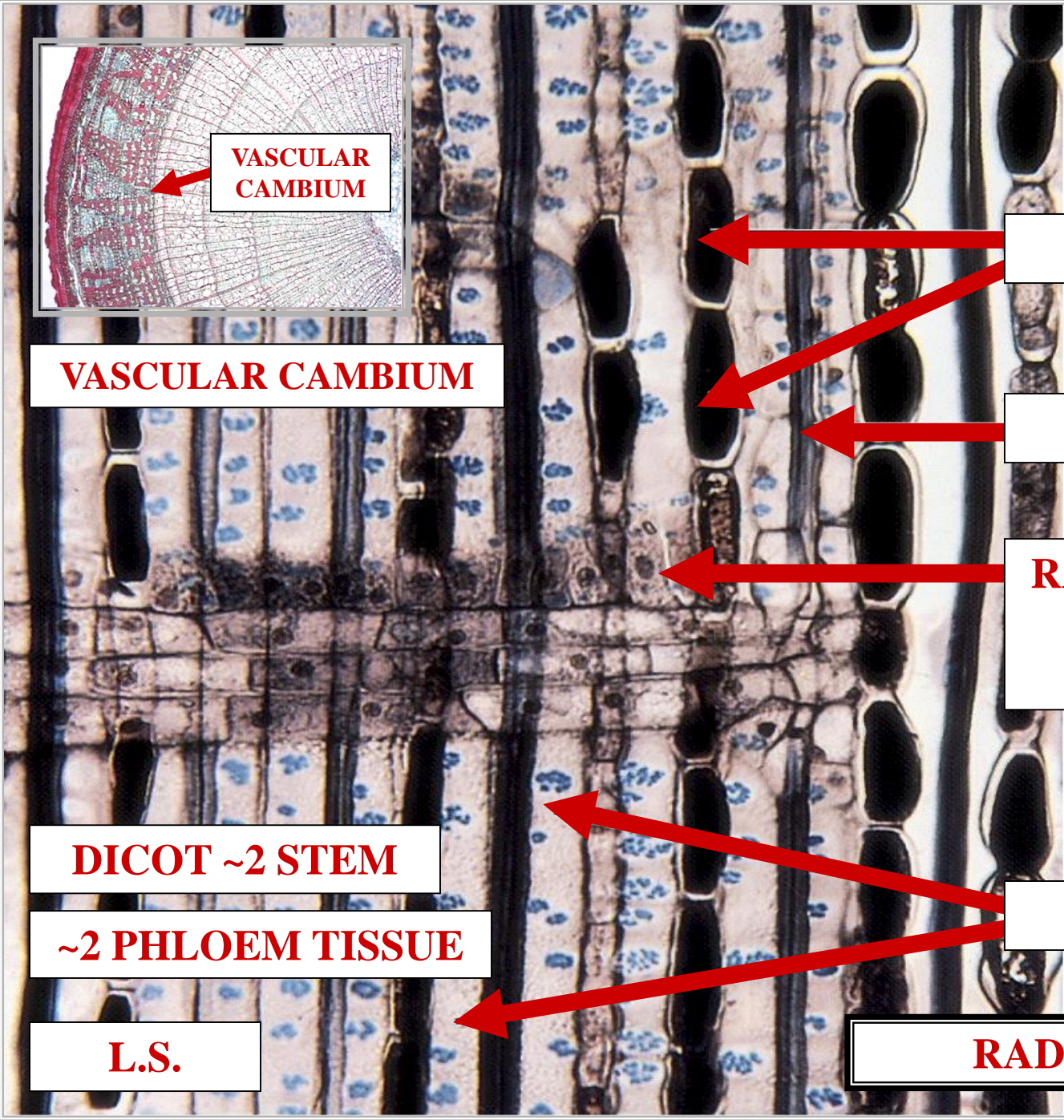

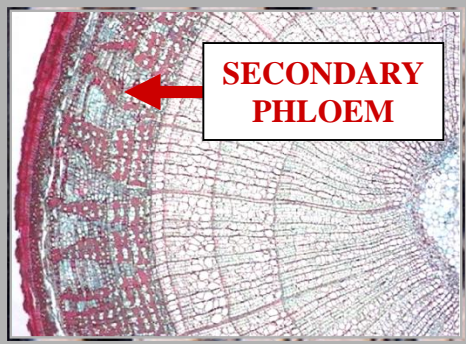

**SECONDARY
PHLOEM**

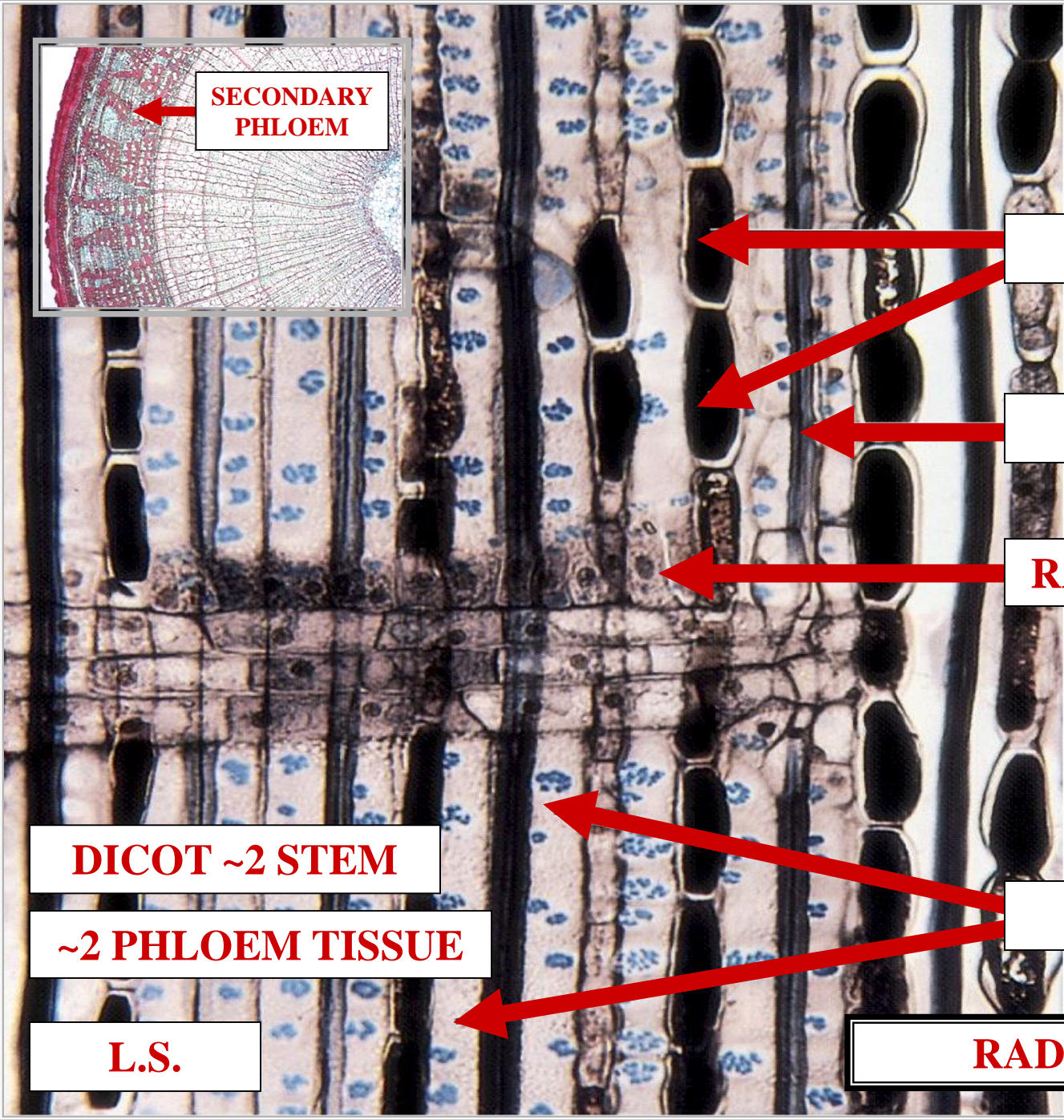

[Empty label box]

[Empty label box]

RAY PARENCHYMA

[Empty label box]

DICOT ~2 STEM

~2 PHLOEM TISSUE

L.S.

RADIAL SECTION

PHLOEM RAY

PHLOEM RAY

**RAY PARENCHYMA
PHLOEM RAY**



VC

RAY WITHIN PHLOEM

**RAY PARENCHYMA
PHLOEM RAY**

2X

**VASCULAR
CAMBIUM**

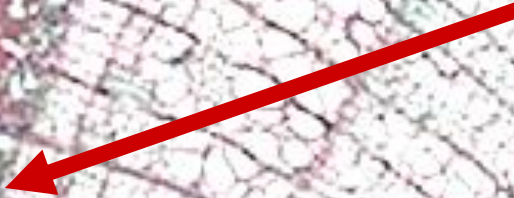

**SECONDARY
PHLOEM**



DICOT ~2 STEM

C.S.

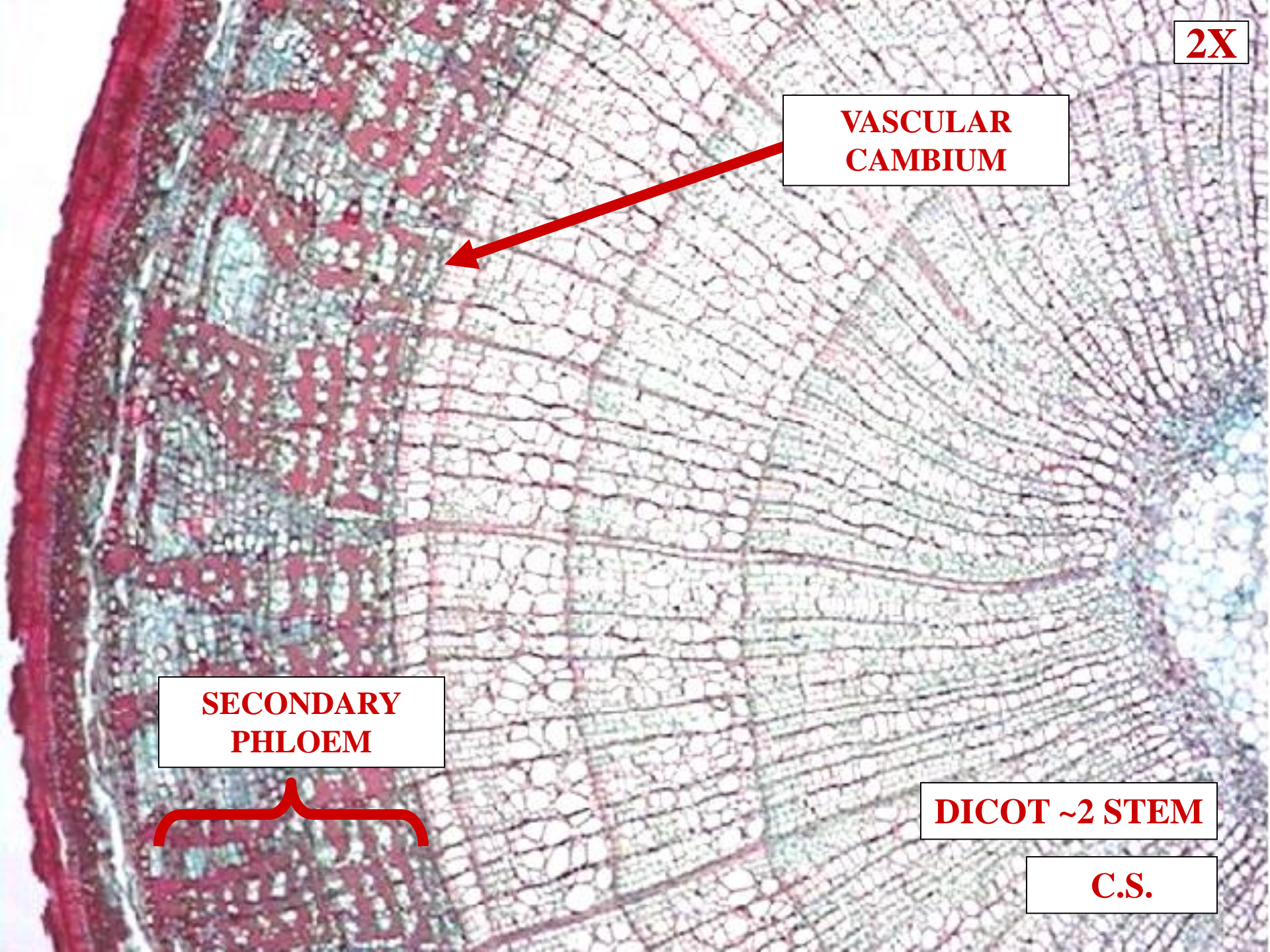

XR

**VASCULAR
CAMBIUM**

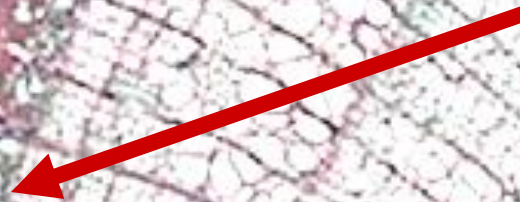

**SECONDARY
XYLEM**



**SECONDARY
PHLOEM**



DICOT ~2 STEM

C.S.

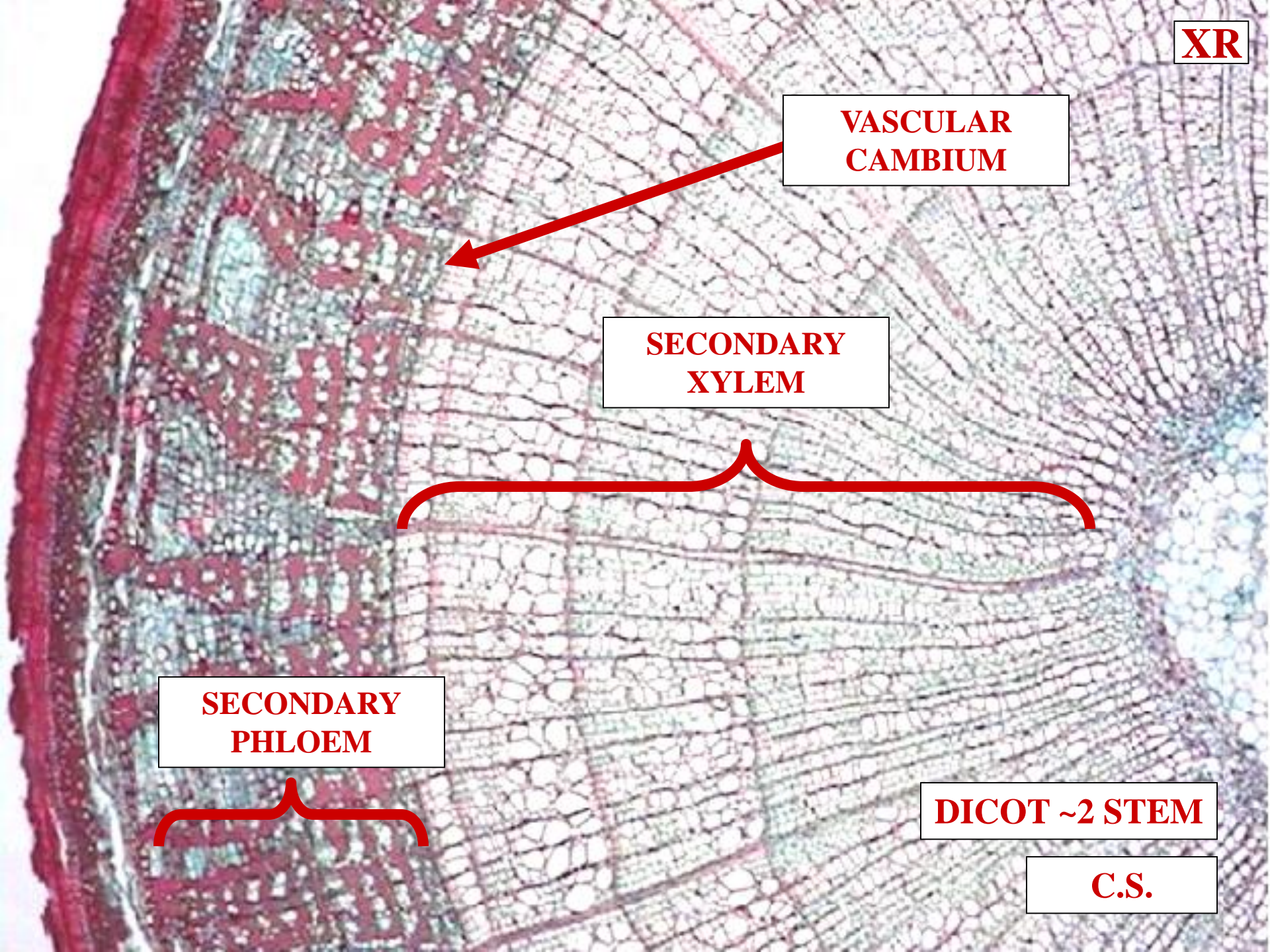

R

**VASCULAR
CAMBIUM**

XYLEM RAY

**SECONDARY
PHLOEM**

DICOT ~2 STEM

C.S.

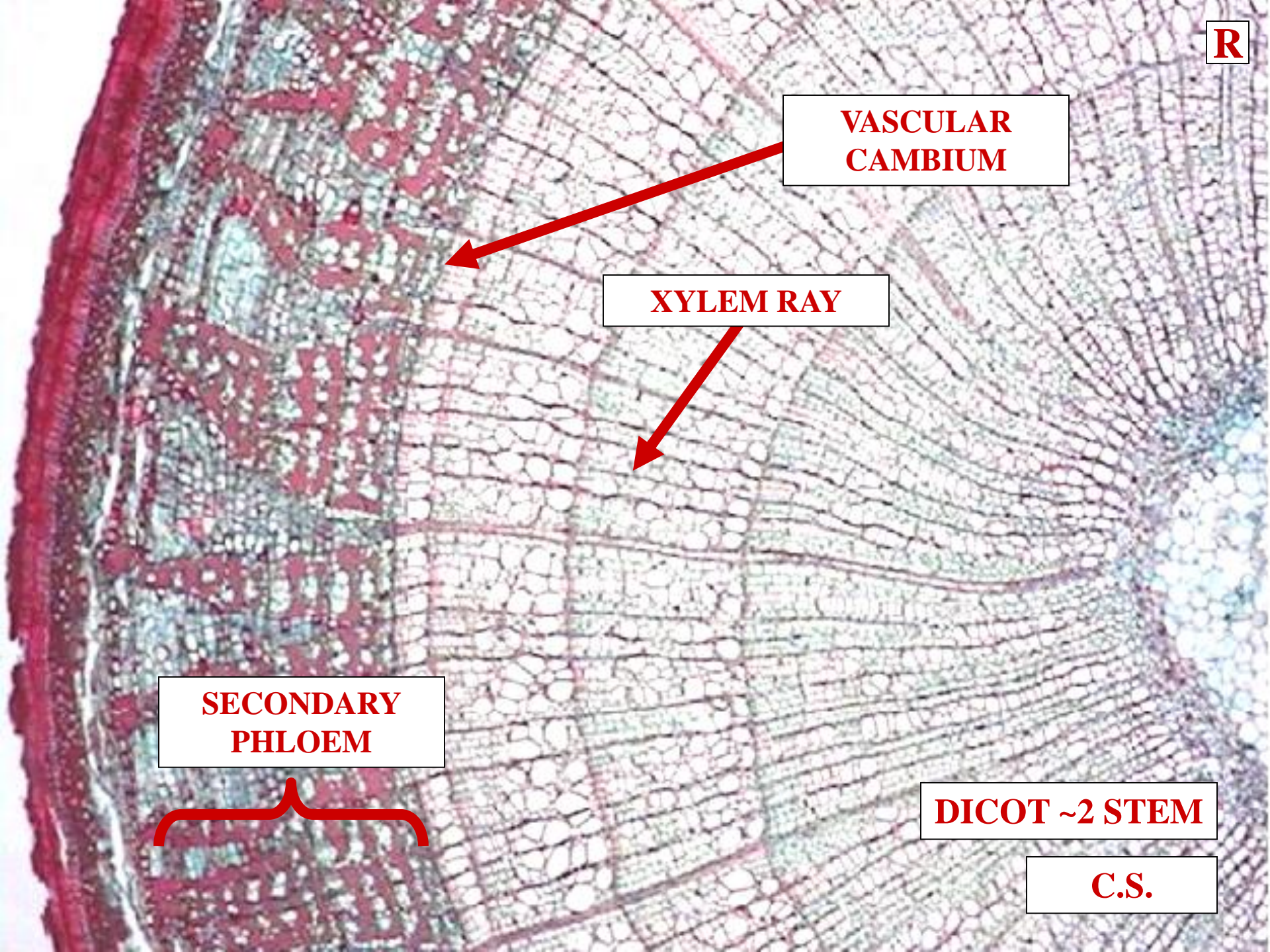

PR

**VASCULAR
CAMBIUM**

RAY

XYLEM RAY

**SECONDARY
PHLOEM**

DICOT ~2 STEM

C.S.

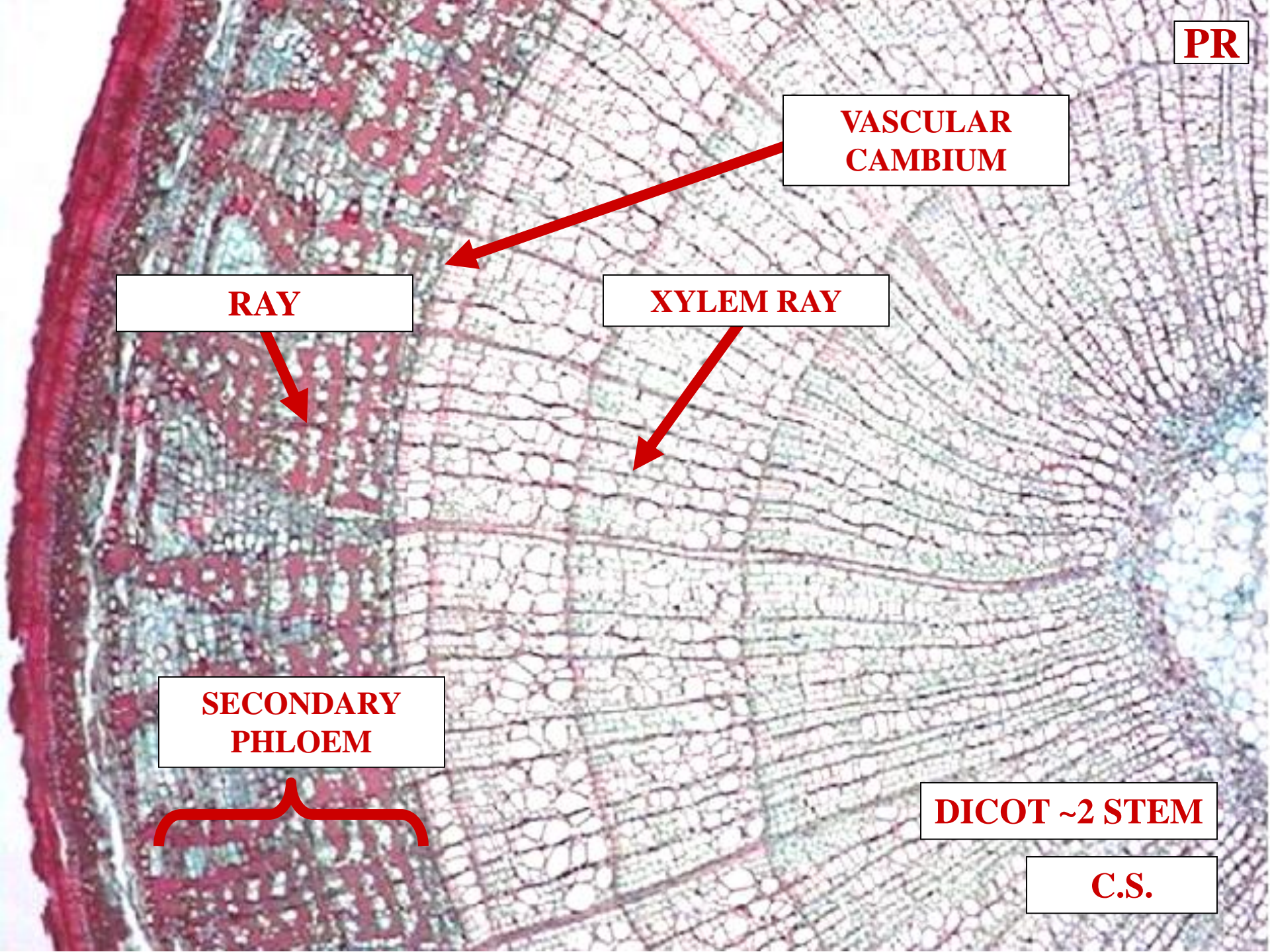

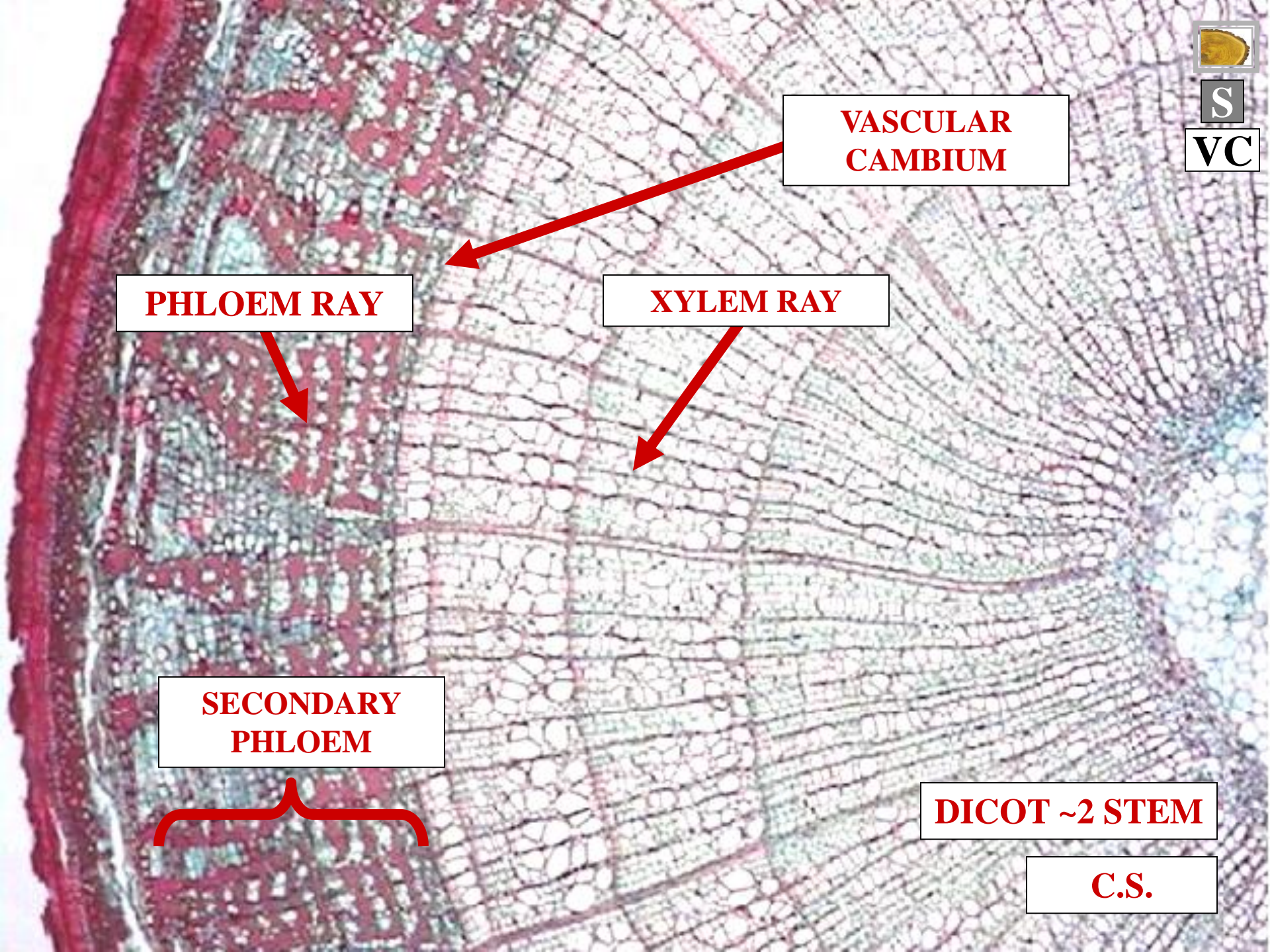

S
VC

**VASCULAR
CAMBIUM**

PHLOEM RAY

XYLEM RAY

**SECONDARY
PHLOEM**

DICOT ~2 STEM

C.S.



VC

VASCULAR CAMBIUM SUMMARY

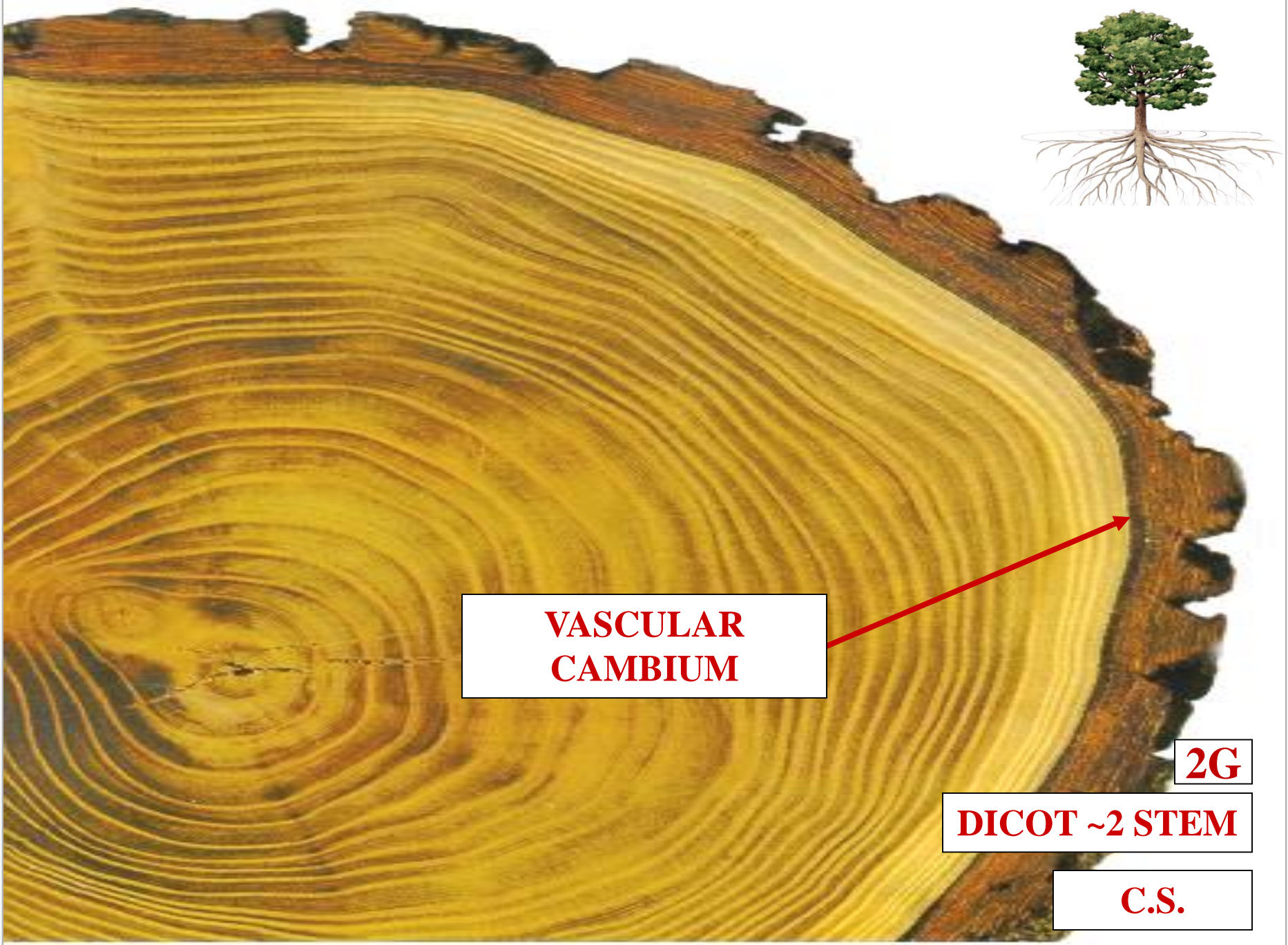
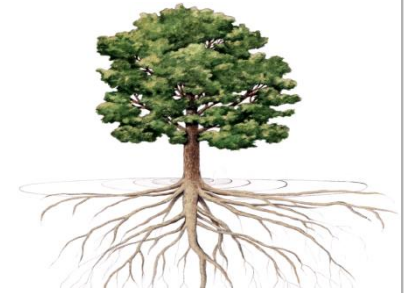

**VASCULAR
CAMBIUM**

2G

DICOT ~2 STEM

C.S.

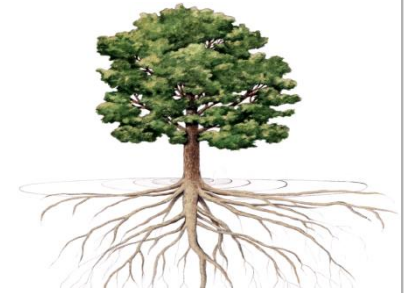

**SECONDARY
GROWTH**

**VASCULAR
CAMBIUM**

2X

DICOT ~2 STEM

C.S.

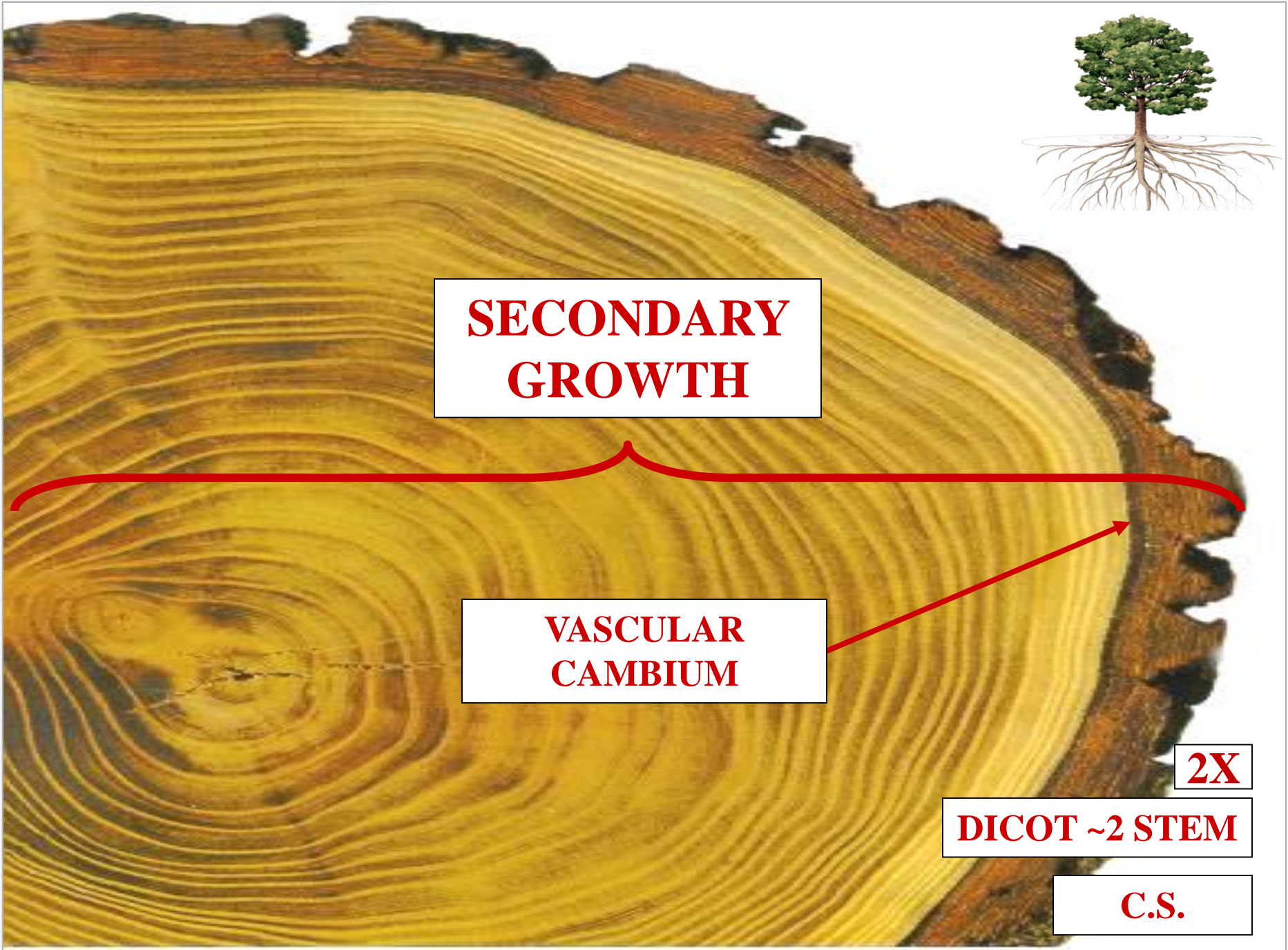

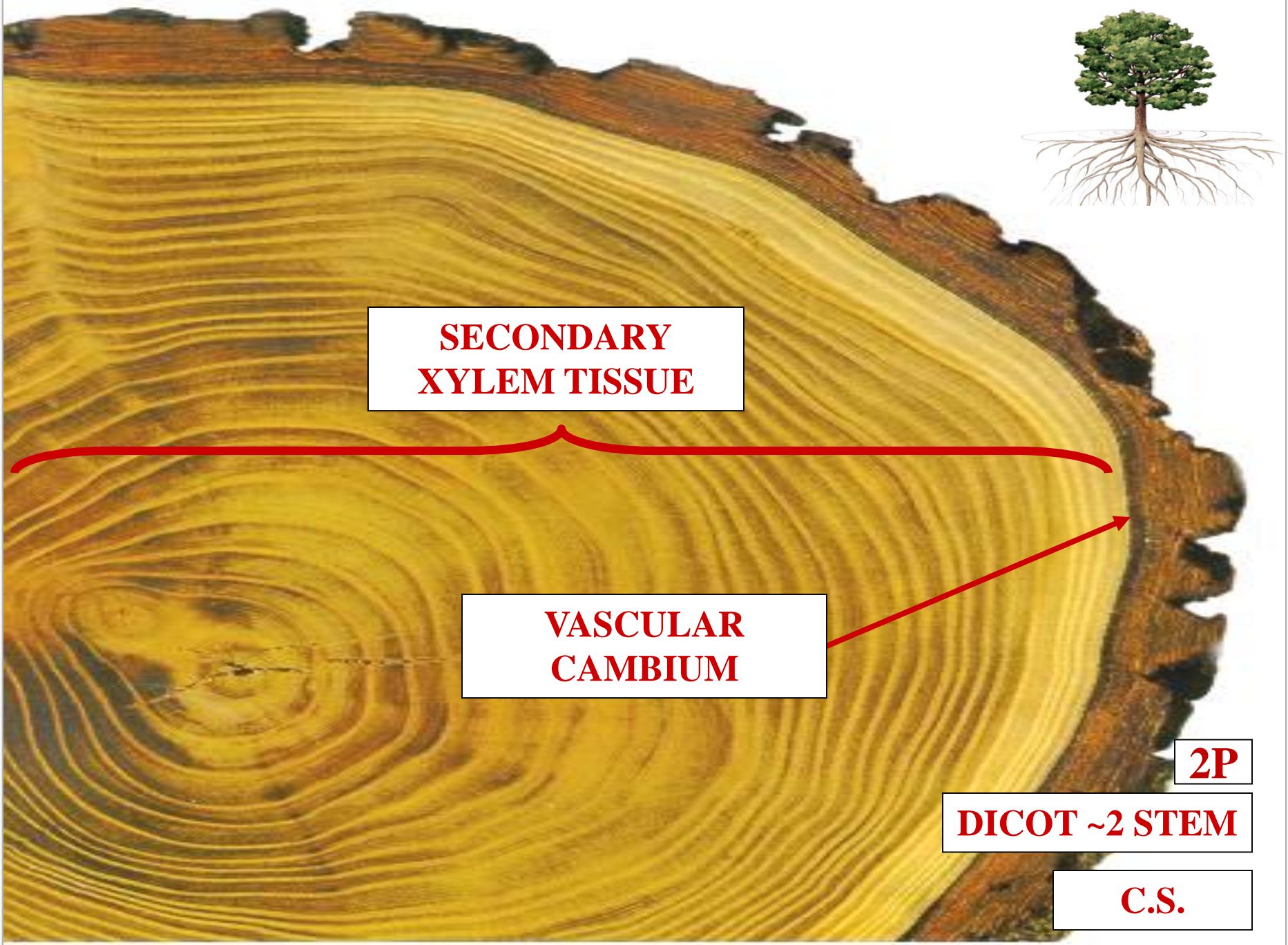
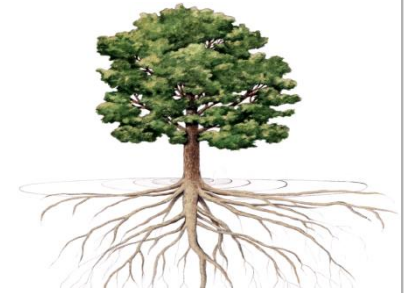

**SECONDARY
XYLEM TISSUE**

**VASCULAR
CAMBIUM**

2P

DICOT ~2 STEM

C.S.

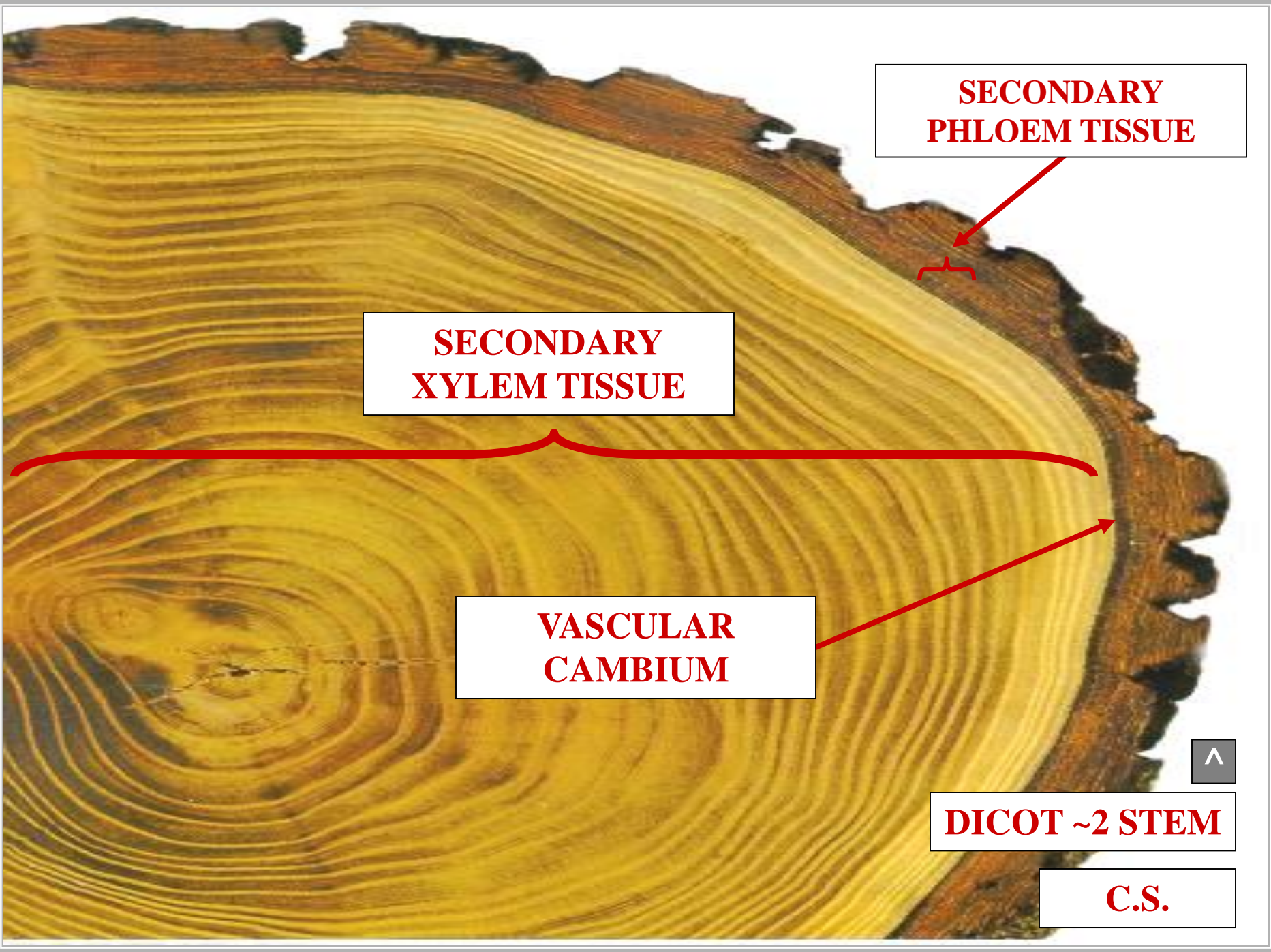

**SECONDARY
PHLOEM TISSUE**

**SECONDARY
XYLEM TISSUE**

**VASCULAR
CAMBIUM**

DICOT ~2 STEM

C.S.



CORK CAMBIUM

CORK
CAMBIUM

SECONDARY GROWTH CORK CAMBIUM



DERIVES OUTER BARK

SECONDARY GROWTH
CORK CAMBIUM

SECONDARY GROWTH CORK CAMBIUM



DERIVES OUTER BARK

CONSISTS PARENCHYMA INITIALS

SECONDARY GROWTH CORK CAMBIUM

SECONDARY GROWTH CORK CAMBIUM



DERIVES OUTER BARK

CONSISTS PARENCHYMA INITIALS

UNDERGO MITOSIS →

SECONDARY GROWTH CORK CAMBIUM

SECONDARY GROWTH CORK CAMBIUM

DERIVES OUTER BARK

CONSISTS PARENCHYMA INITIALS

UNDERGO MITOSIS →

DERIVATIVES

SECONDARY GROWTH
CORK CAMBIUM





**CORK
CAMBIUM**



DICOT ~2 STEM

C.S.

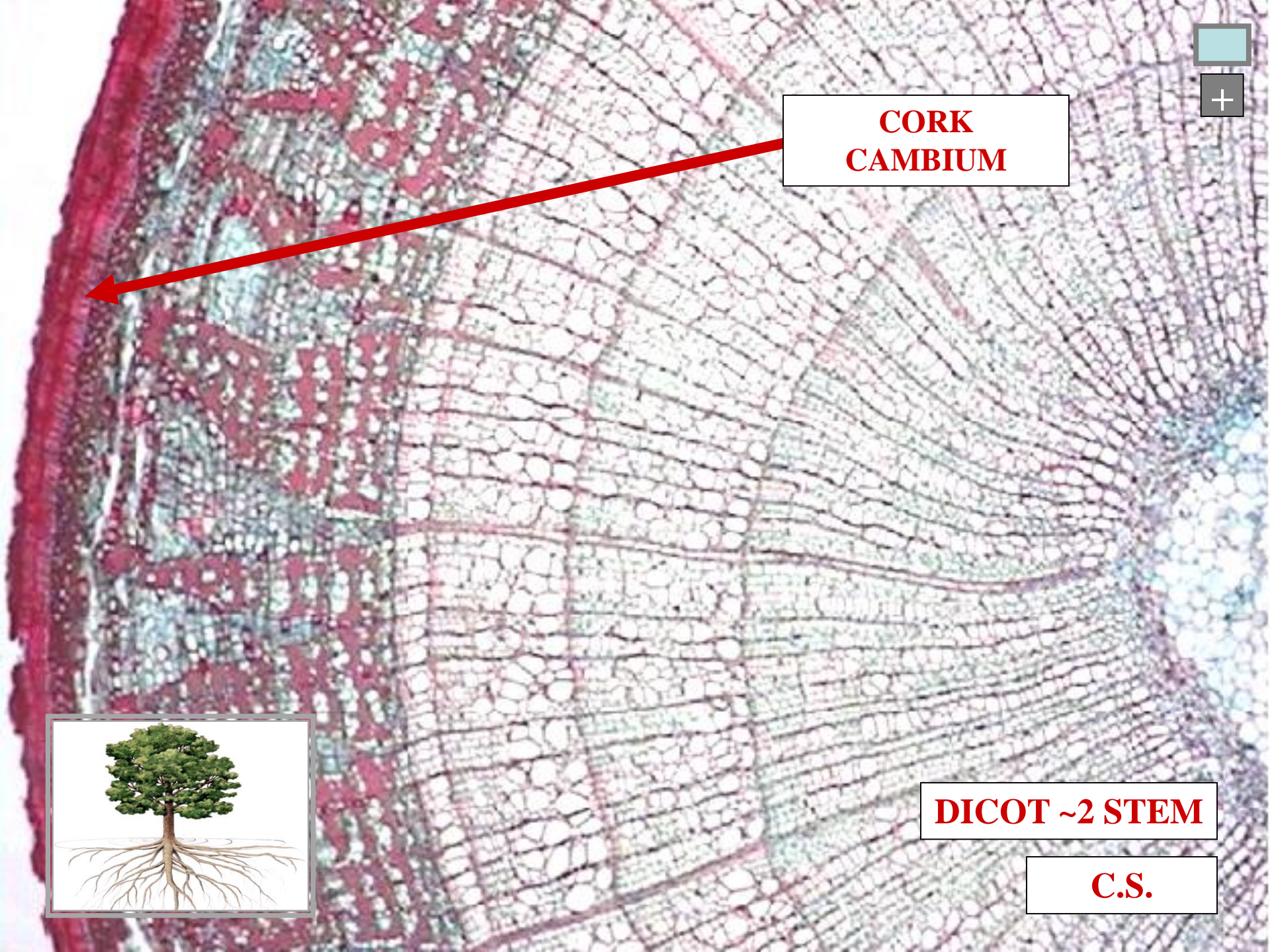



**CORK
CAMBIUM**

DICOT ~ 2 STEM

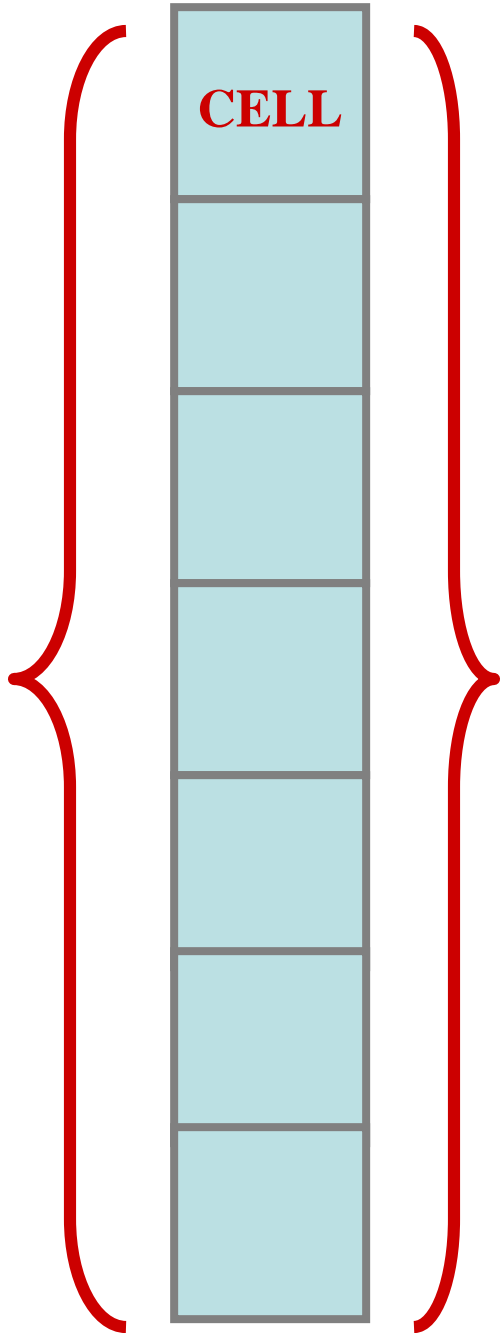

CELL

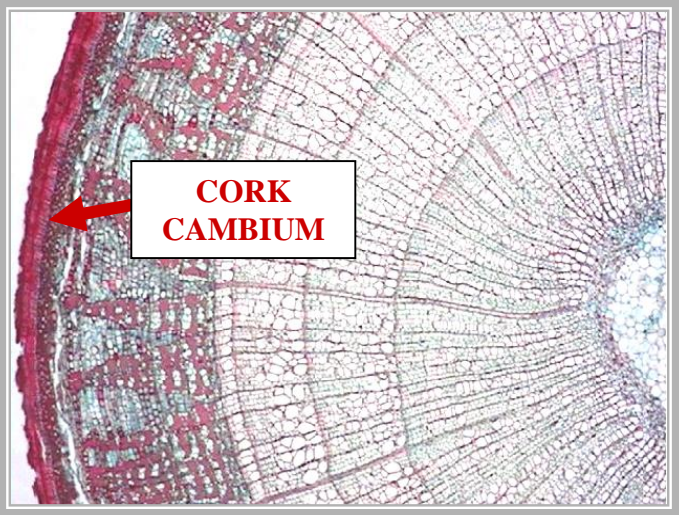

**CORK
CAMBIUM**

**CORK
CAMBIUM**

PC

C.S.

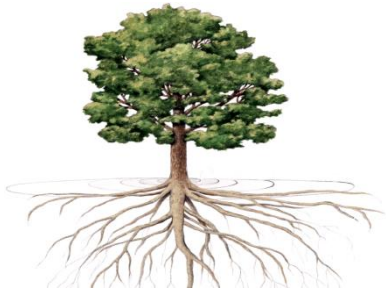

CELL

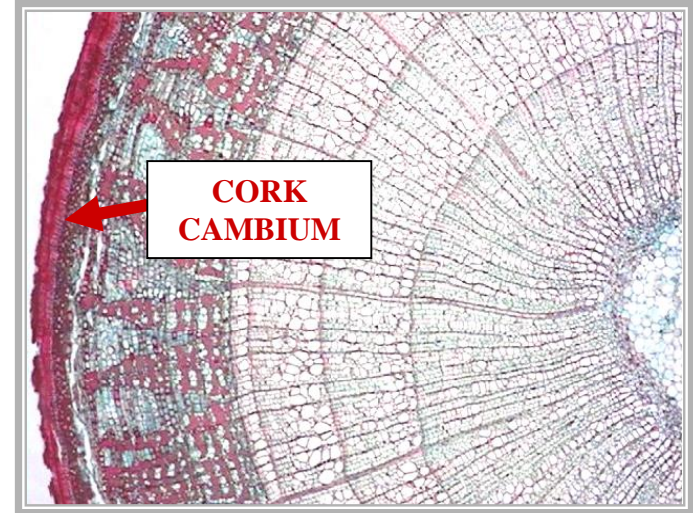

**PARENCHYMA
INITIALS**

**PARENCHYMA
INITIALS**

M

DICOT ~ 2 STEM

C.S.



CELL

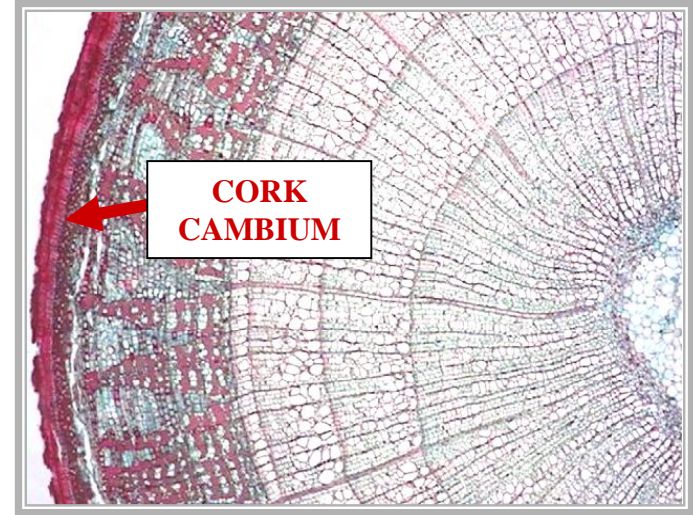

**CORK
CAMBIUM**

MITOSIS

MITOSIS

DICOT ~ 2 STEM

C.S.

**OUTSIDE
CORK
CAMBIUM**

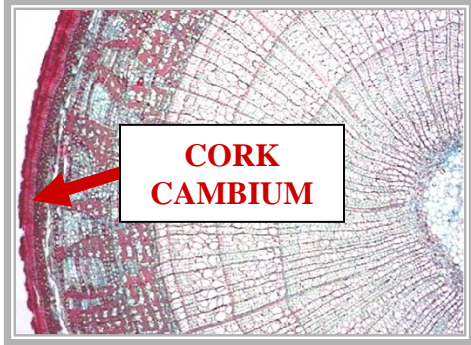

**CORK
CAMBIUM**

CELL

**INSIDE
CORK
CAMBIUM**

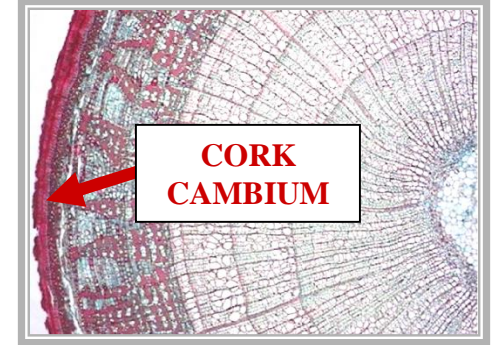

**CORK
CAMBIUM**

MITOSIS

OUTSIDE

**DERIVATIVE
PARENCHYMA
CELLS**

DICOT ~ 2 STEM

**CORK
CAMBIUM**

C.S.



**OUTSIDE
CORK
CAMBIUM**

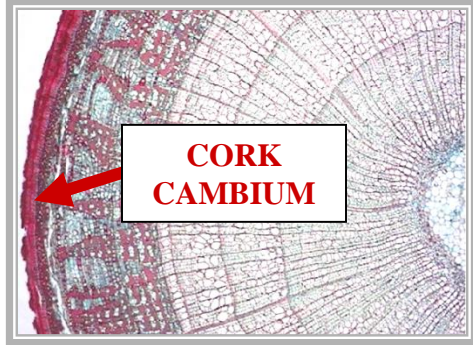

**CORK
CAMBIUM**

CELL

**INSIDE
CORK
CAMBIUM**

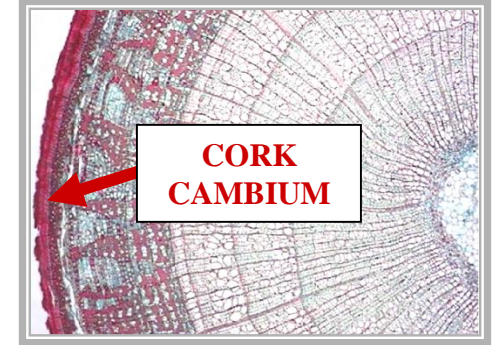

**CORK
CAMBIUM**

MITOSIS

OUTSIDE

INSIDE

**DERIVATIVE
PARENCHYMA
CELLS**

**DERIVATIVE
PARENCHYMA
CELLS**

DICOT ~ 2 STEM

**CORK
CAMBIUM**

C.S.

0



**OUTSIDE
CORK
CAMBIUM**

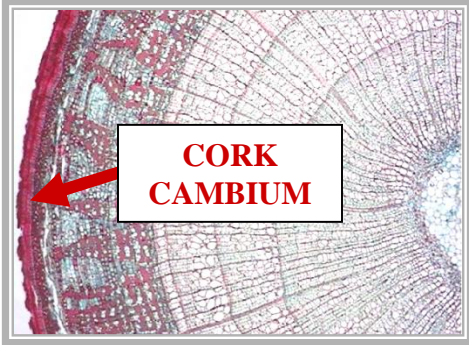

**INSIDE
CORK
CAMBIUM**

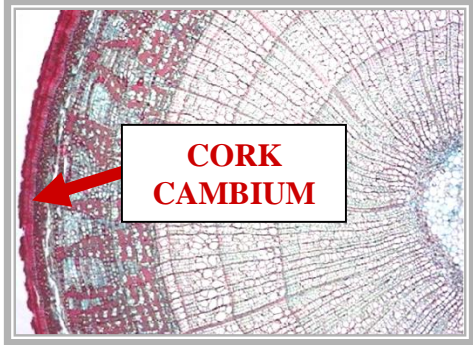

OUTSIDE

**DERIVATIVE
PARENCHYMA
CELLS**

DICOT ~ 2 STEM



**CORK
CAMBIUM**

C.S.

**OUTSIDE
CORK
CAMBIUM**

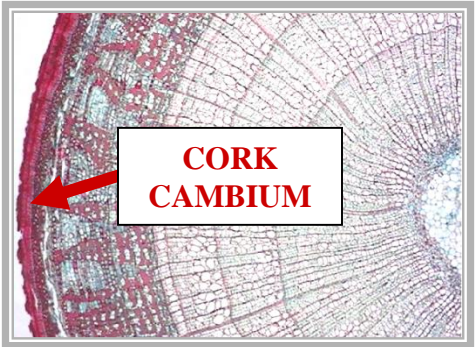

**INSIDE
CORK
CAMBIUM**

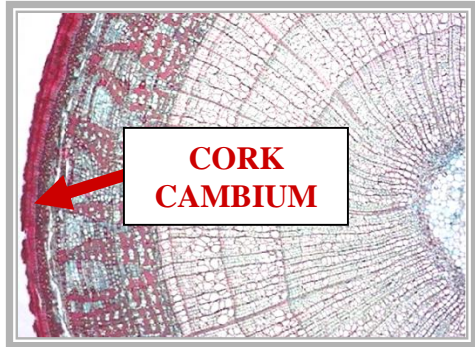

OUTSIDE

DIFFERENTIATE

DICOT ~ 2 STEM

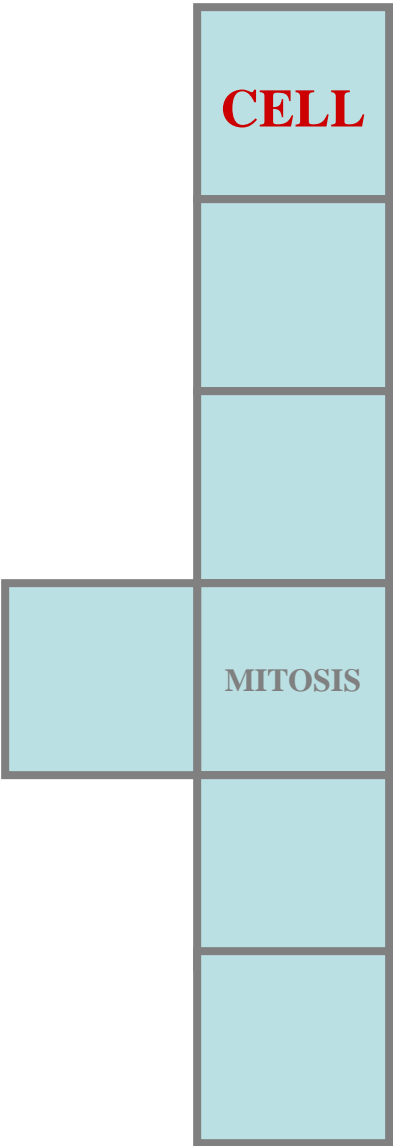

**CORK
CAMBIUM**

C.S.

**OUTSIDE
CORK
CAMBIUM**

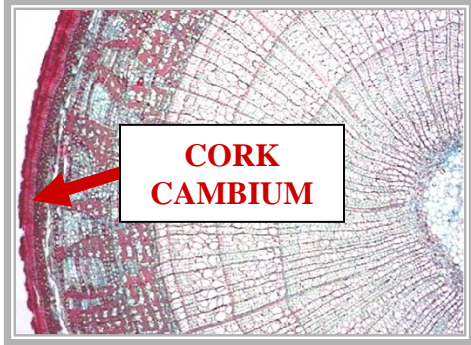

**CORK
CAMBIUM**

CELL

**INSIDE
CORK
CAMBIUM**

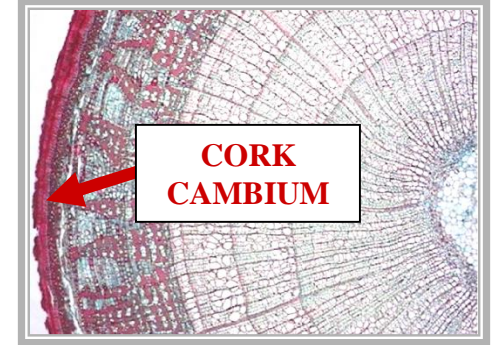

**CORK
CAMBIUM**

I
→

OUTSIDE

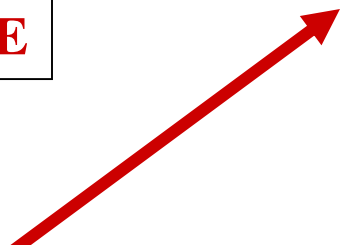

CORK

MITOSIS

**CORK
CAMBIUM**

DICOT ~ 2 STEM

C.S.

**OUTSIDE
CORK
CAMBIUM**

**INSIDE
CORK
CAMBIUM**

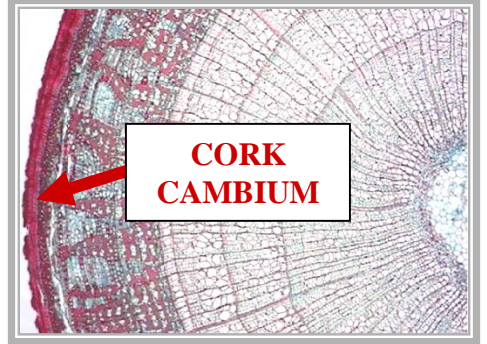
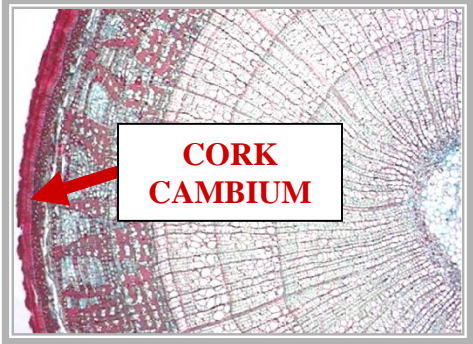

**CORK
CAMBIUM**

**CORK
CAMBIUM**

OUTSIDE

INSIDE

CORK

**DERIVATIVE
PARENCHYMA
CELLS**

DICOT ~ 2 STEM

**CORK
CAMBIUM**

C.S.



MITOSIS

CELL

**OUTSIDE
CORK
CAMBIUM**

**INSIDE
CORK
CAMBIUM**

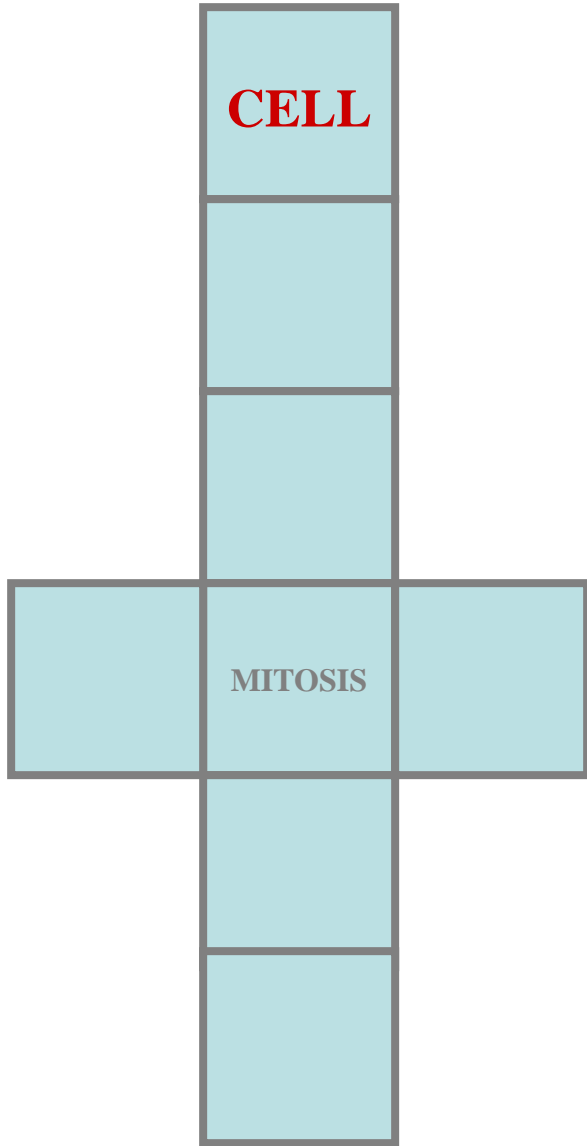
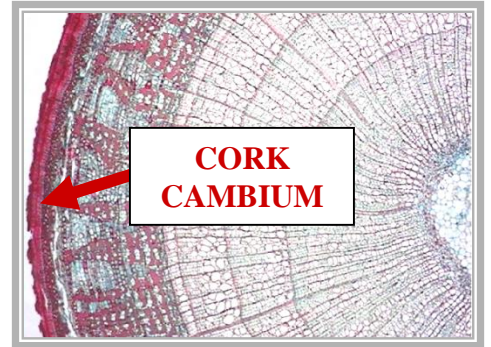
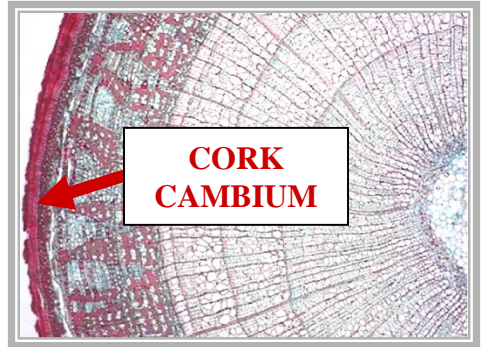

OUTSIDE

INSIDE

CORK

DIFFERENTIATE

DICOT ~ 2 STEM

**CORK
CAMBIUM**

C.S.

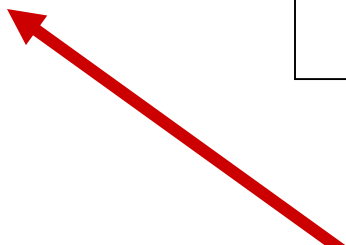
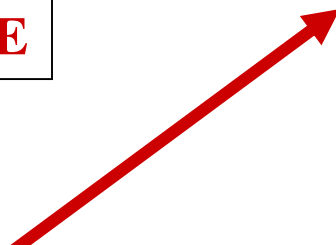



**OUTSIDE
CORK
CAMBIUM**

**INSIDE
CORK
CAMBIUM**

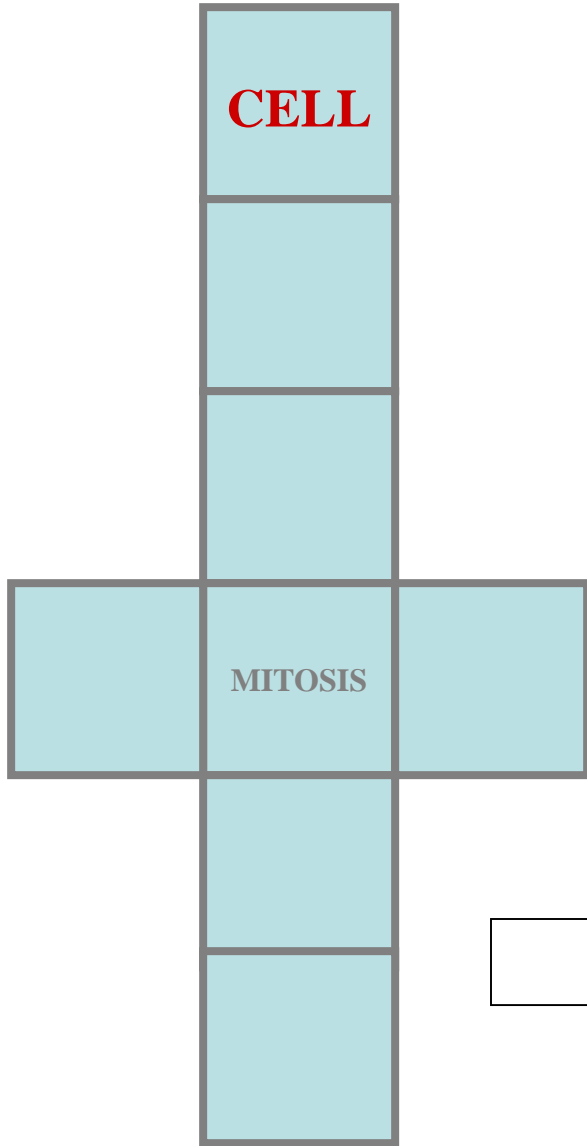
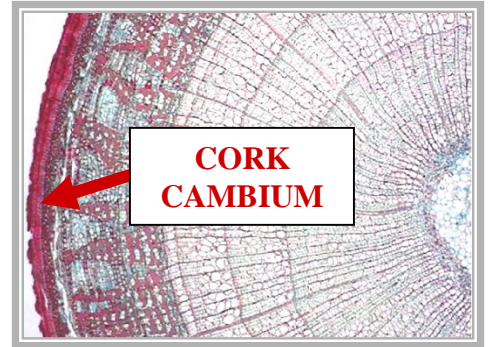
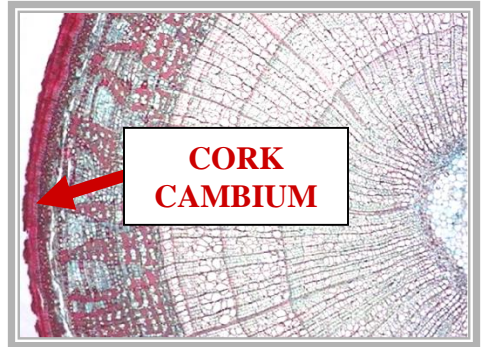

OUTSIDE

INSIDE

CORK

PHELLODERM

DICOT ~ 2 STEM

**CORK
CAMBIUM**

C.S.



CORK

CAMBIUM

SUMMARY

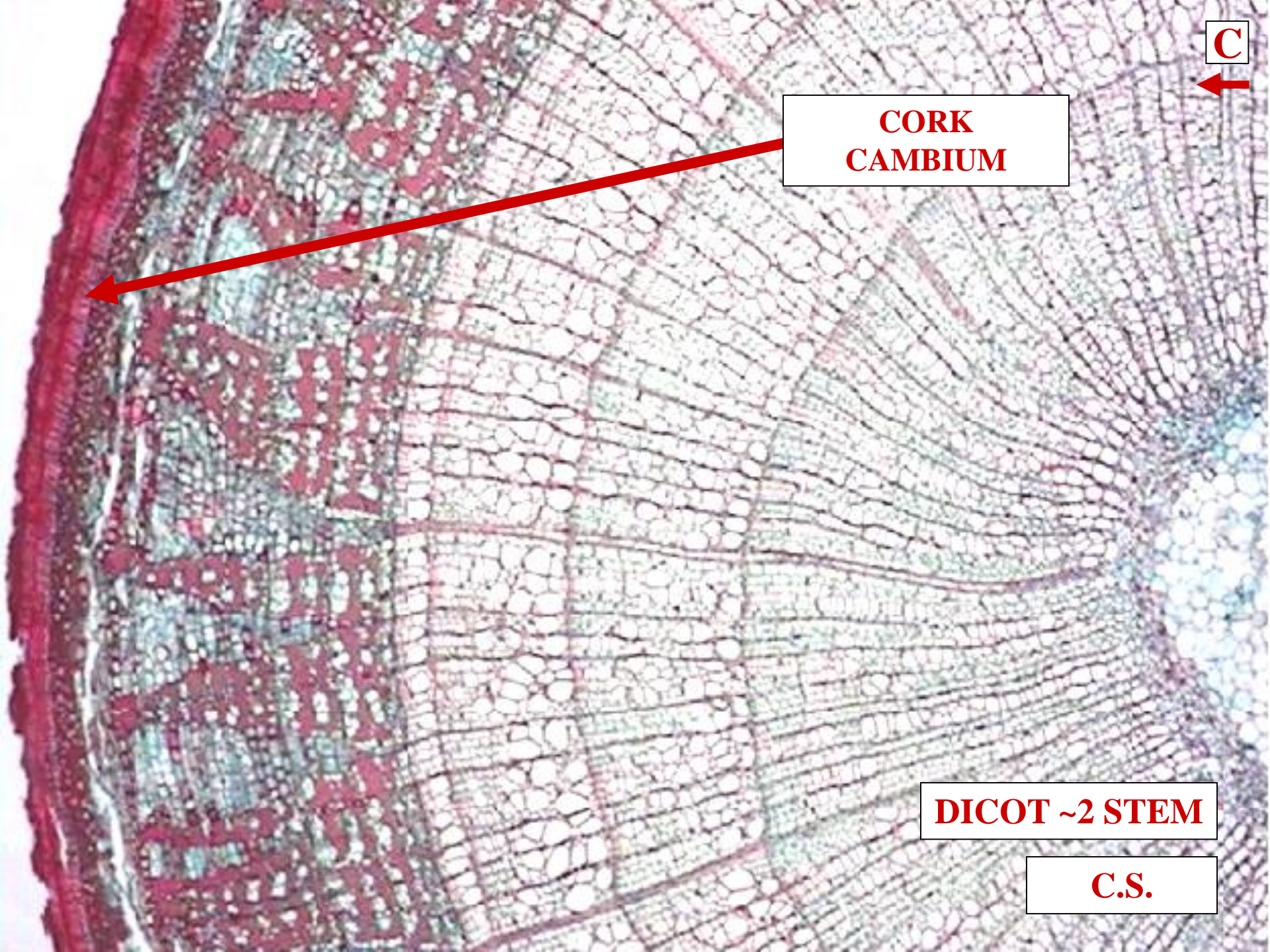

C



**CORK
CAMBIUM**

DICOT ~2 STEM

C.S.

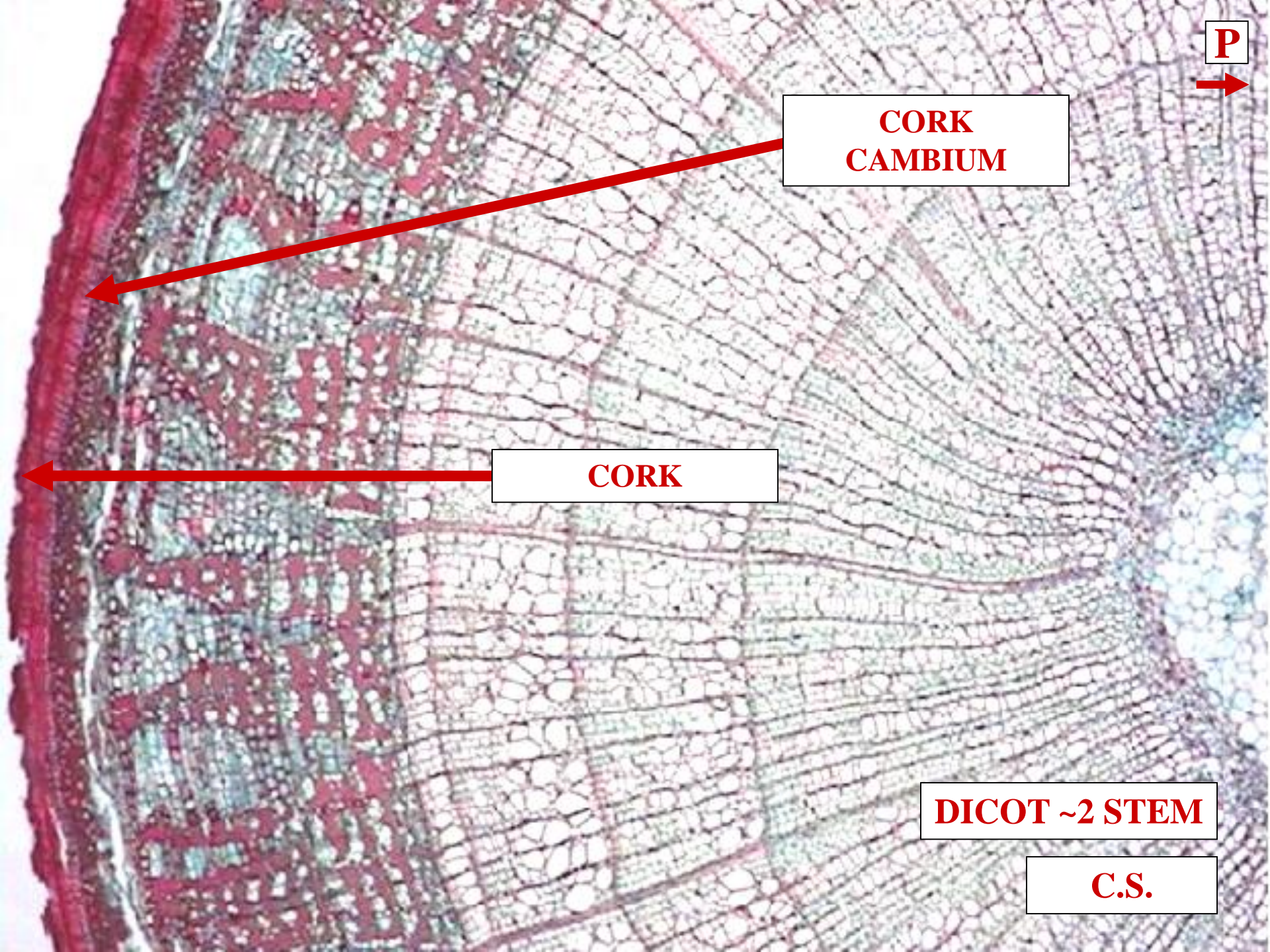

P



**CORK
CAMBIUM**



CORK



DICOT ~2 STEM

C.S.

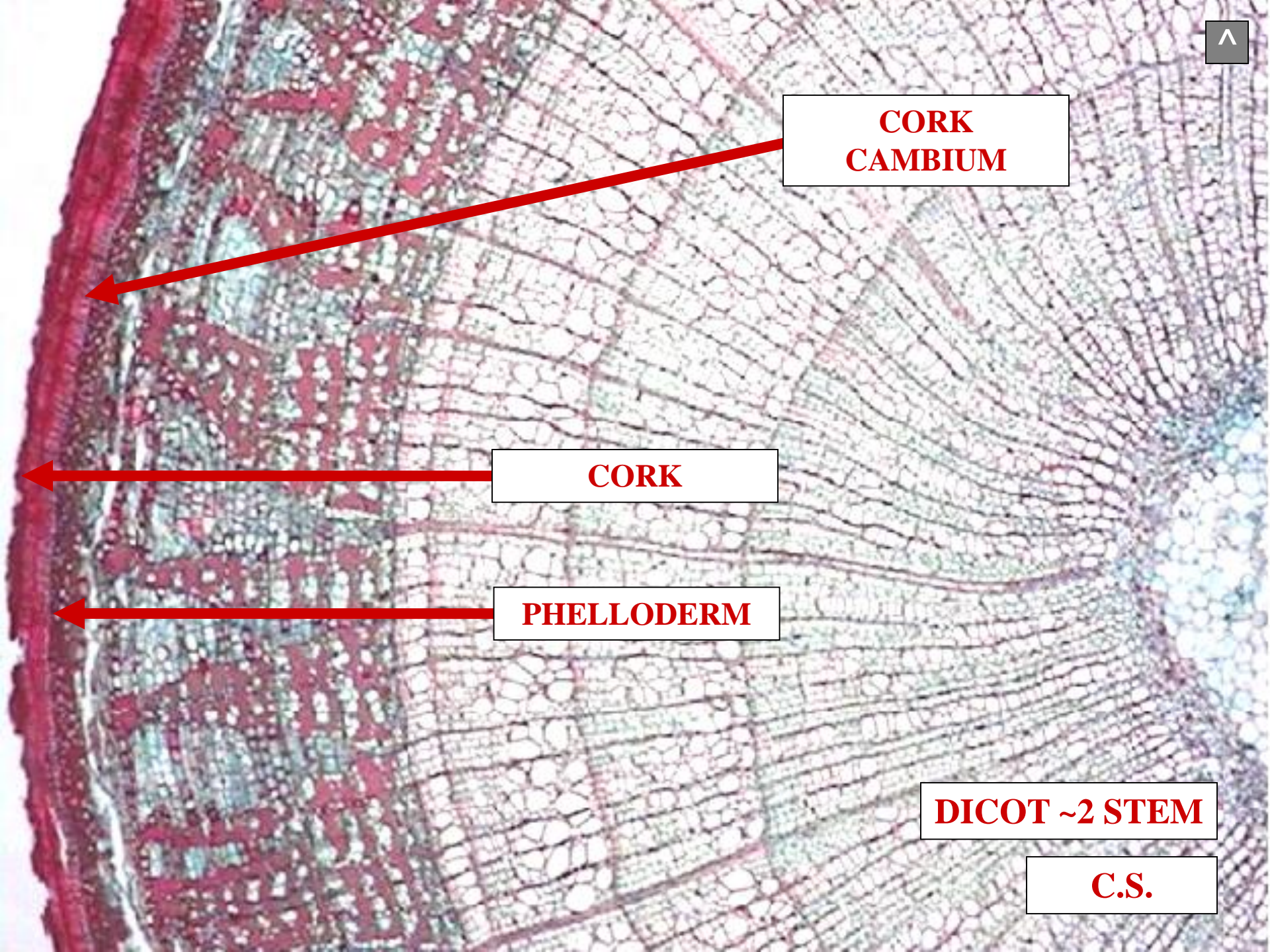

**CORK
CAMBIUM**



CORK



PHELLODERM



DICOT ~2 STEM

C.S.

**CORK
CAMBIUM
ORIGIN**



CORK
CAMBIUM
ORIGIN
STEM

DICOT ~1 STEM

C

EPIDERMIS

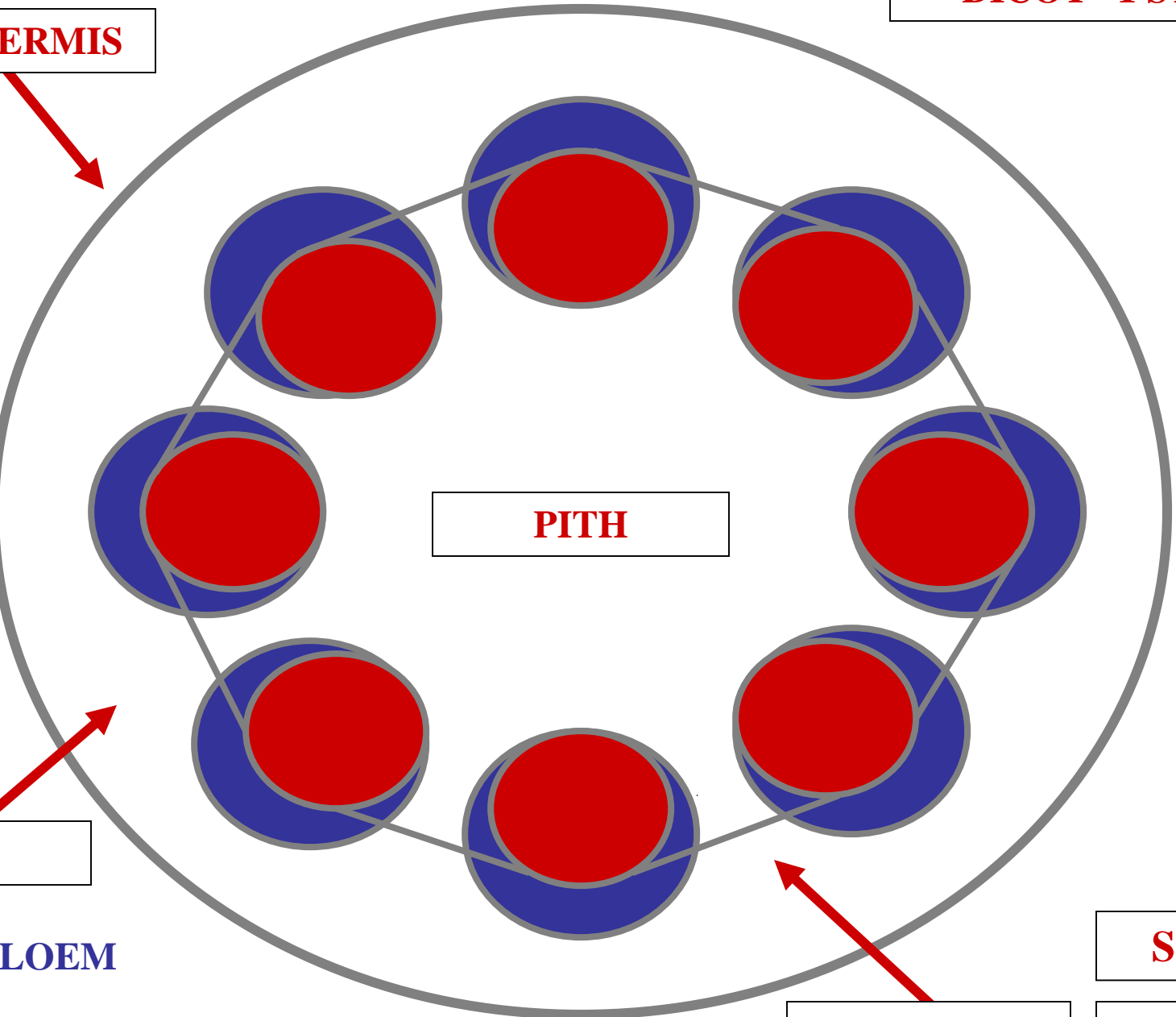

PITH

?

PHLOEM

XYLEM

STEM

PITH RAY

C.S.

DICOT ~1 STEM

CC

EPIDERMIS



PITH

CORTEX

STEM

PITH RAY

C.S.

-  = **PHLOEM**
-  = **XYLEM**

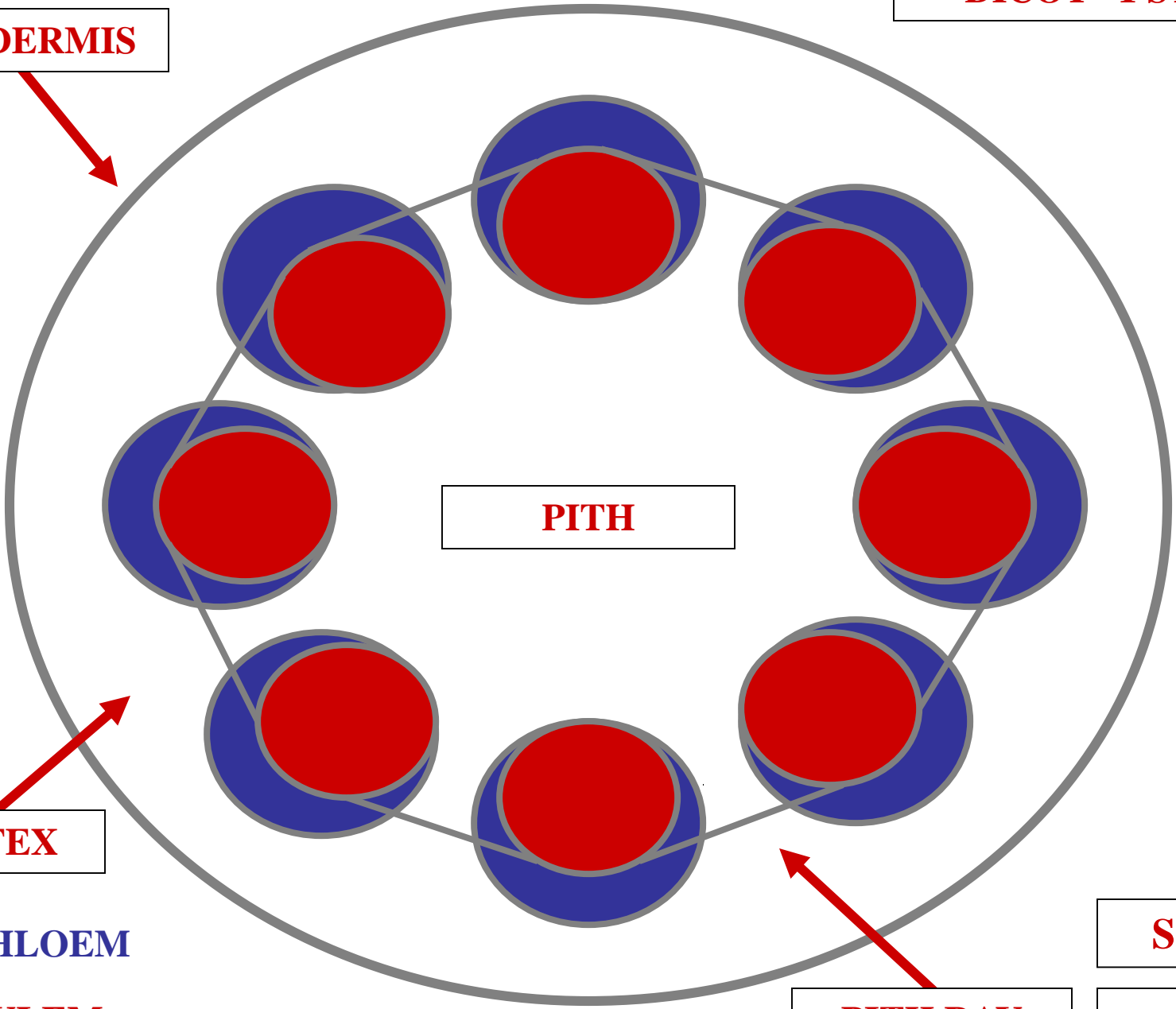

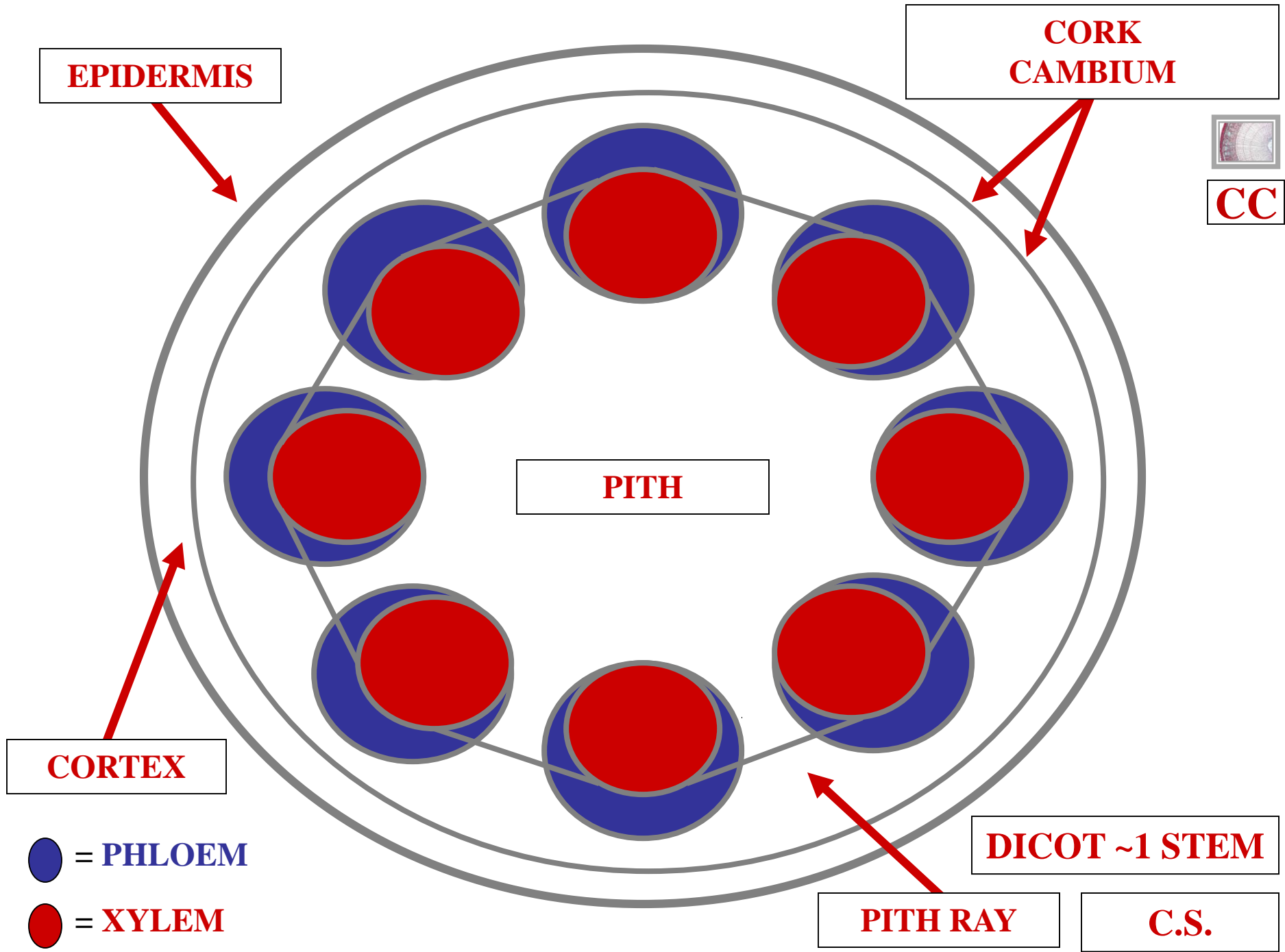



**CORK
CAMBIUM**



CORTEX



DICOT ~2 STEM

C.S.

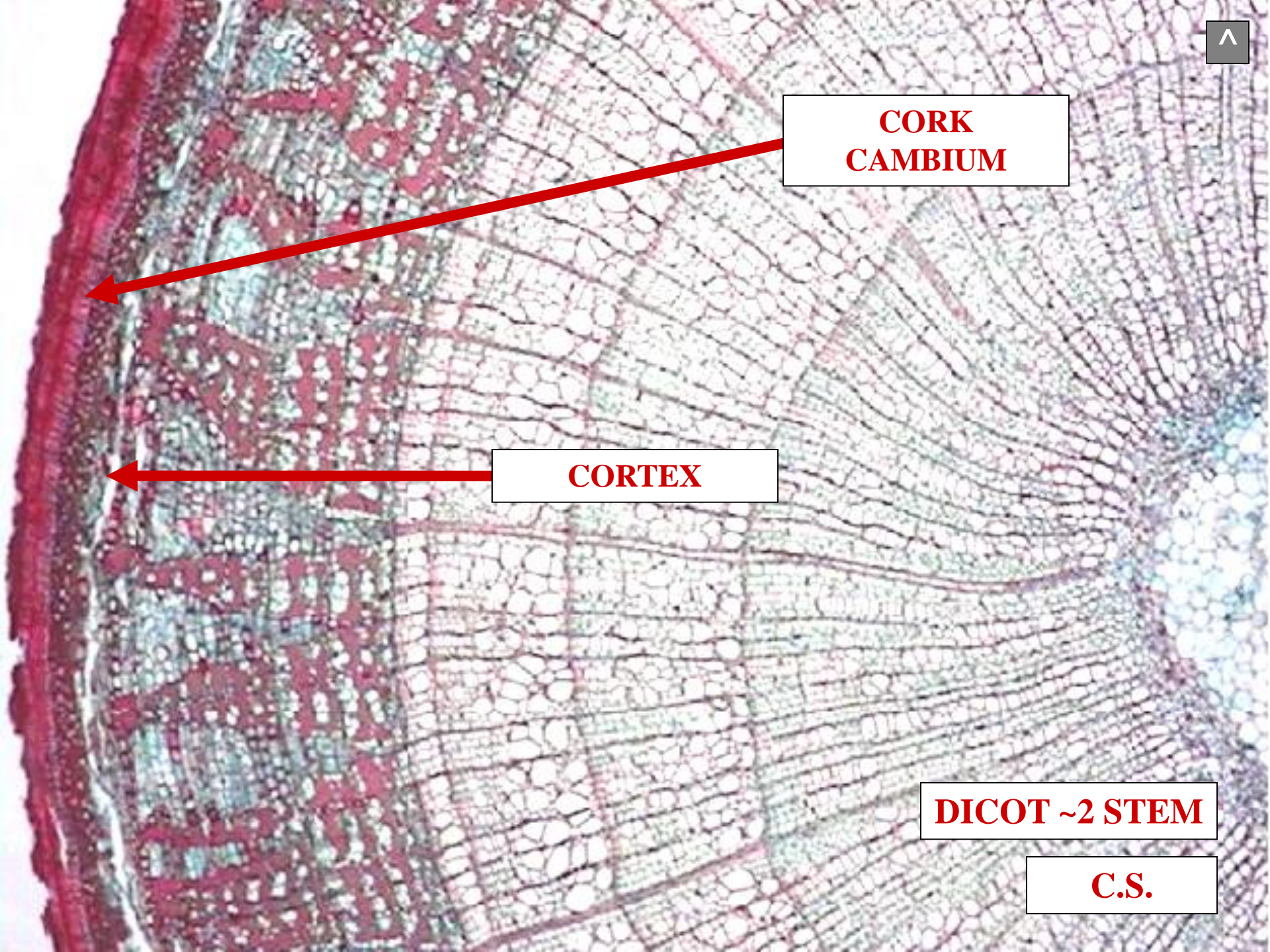



CORK
CAMBIUM
ORIGIN
ROOT

DICOT ~1 ROOT

EPIDERMIS

VASCULAR STELE

CORTEX

ENDODERMIS

PERICYCLE

VASCULAR CAMBIUM

C.S.

● = PHLOEM

● = XYLEM

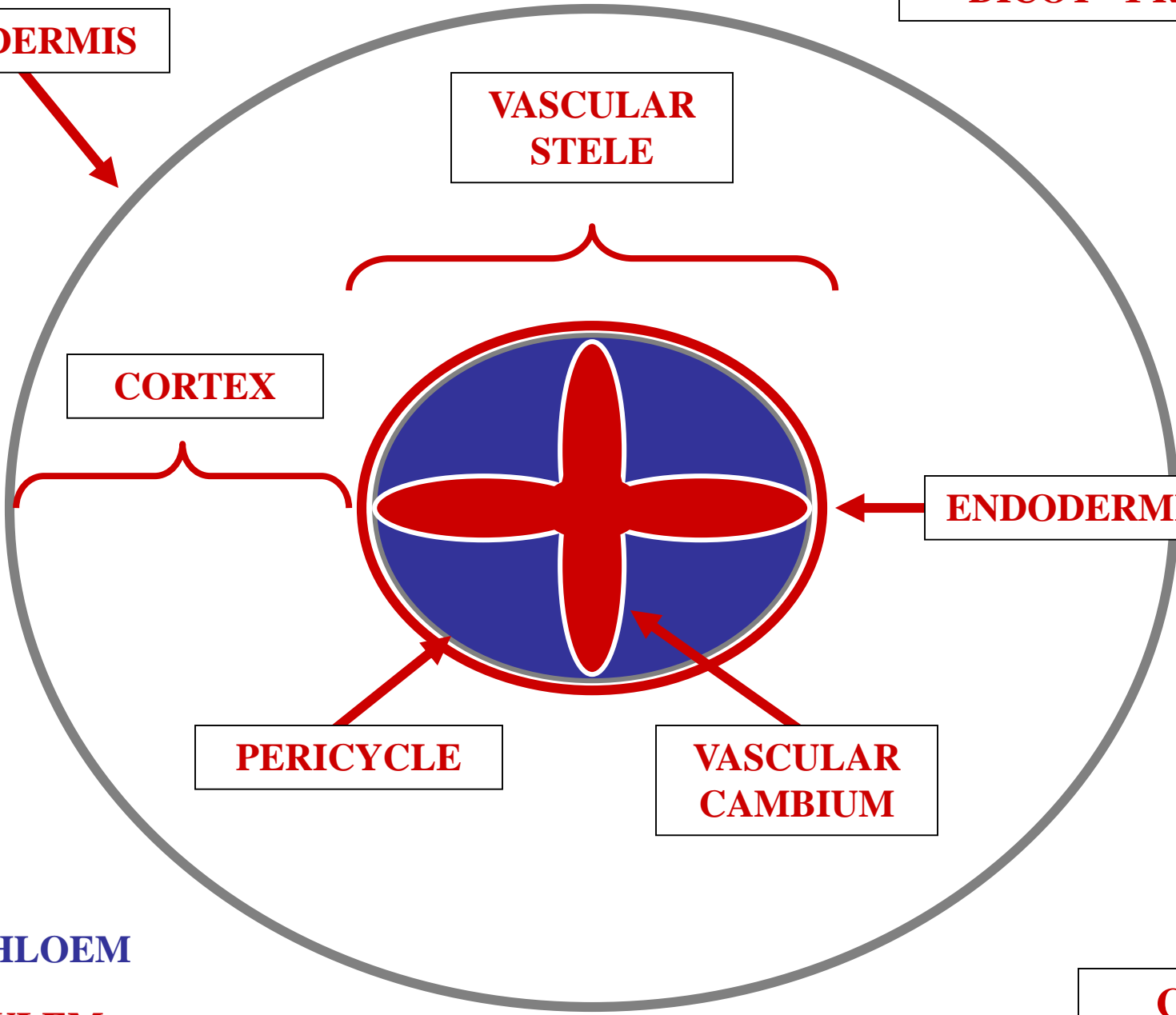

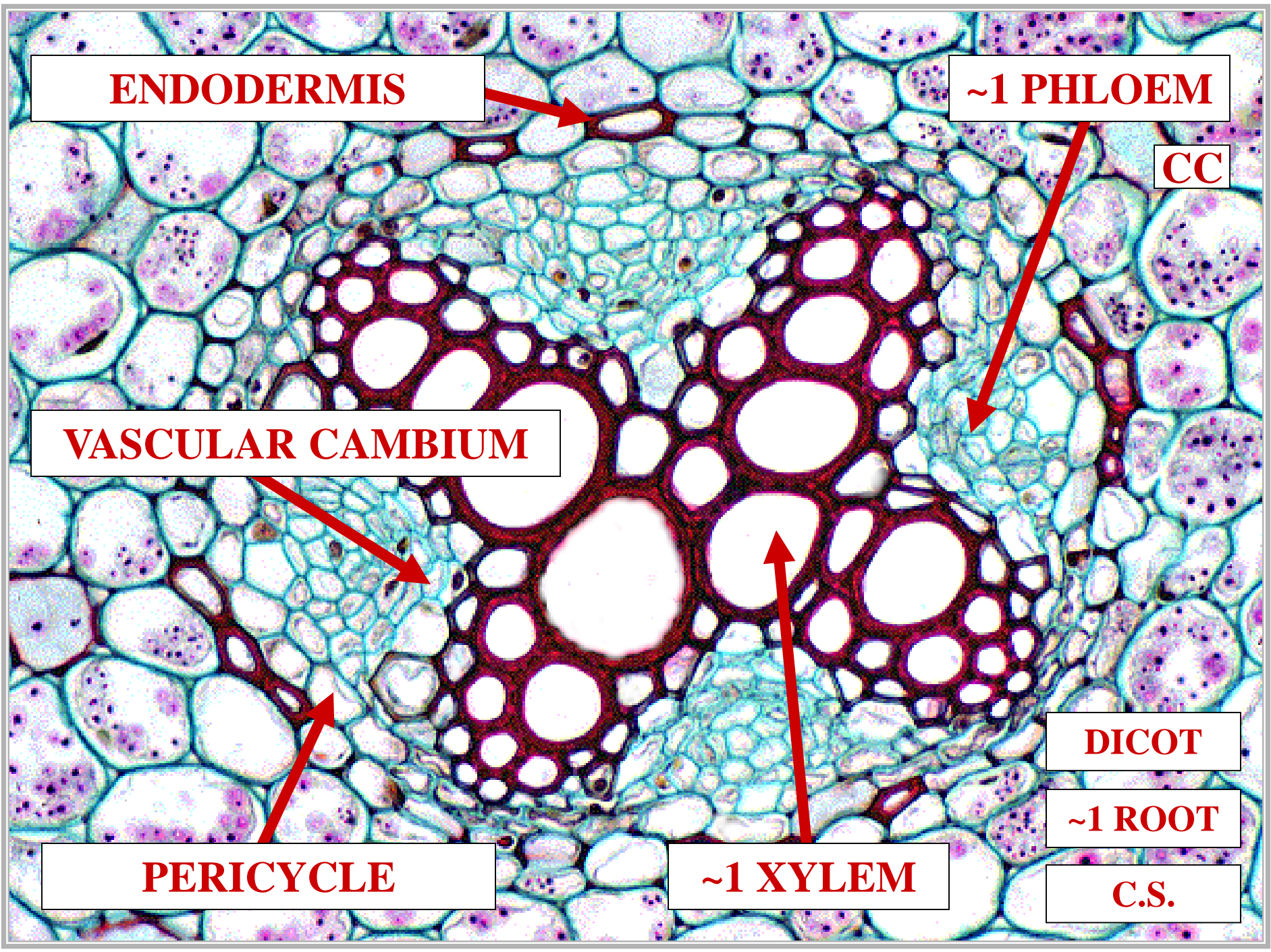

ENDODERMIS

~1 PHLOEM

CC

VASCULAR CAMBIUM

PERICYCLE

~1 XYLEM

DICOT

~1 ROOT

C.S.

ENDODERMIS

~1 PHLOEM

VASCULAR CAMBIUM

CORK CAMBIUM

~1 XYLEM

DICOT

~1 ROOT

C.S.

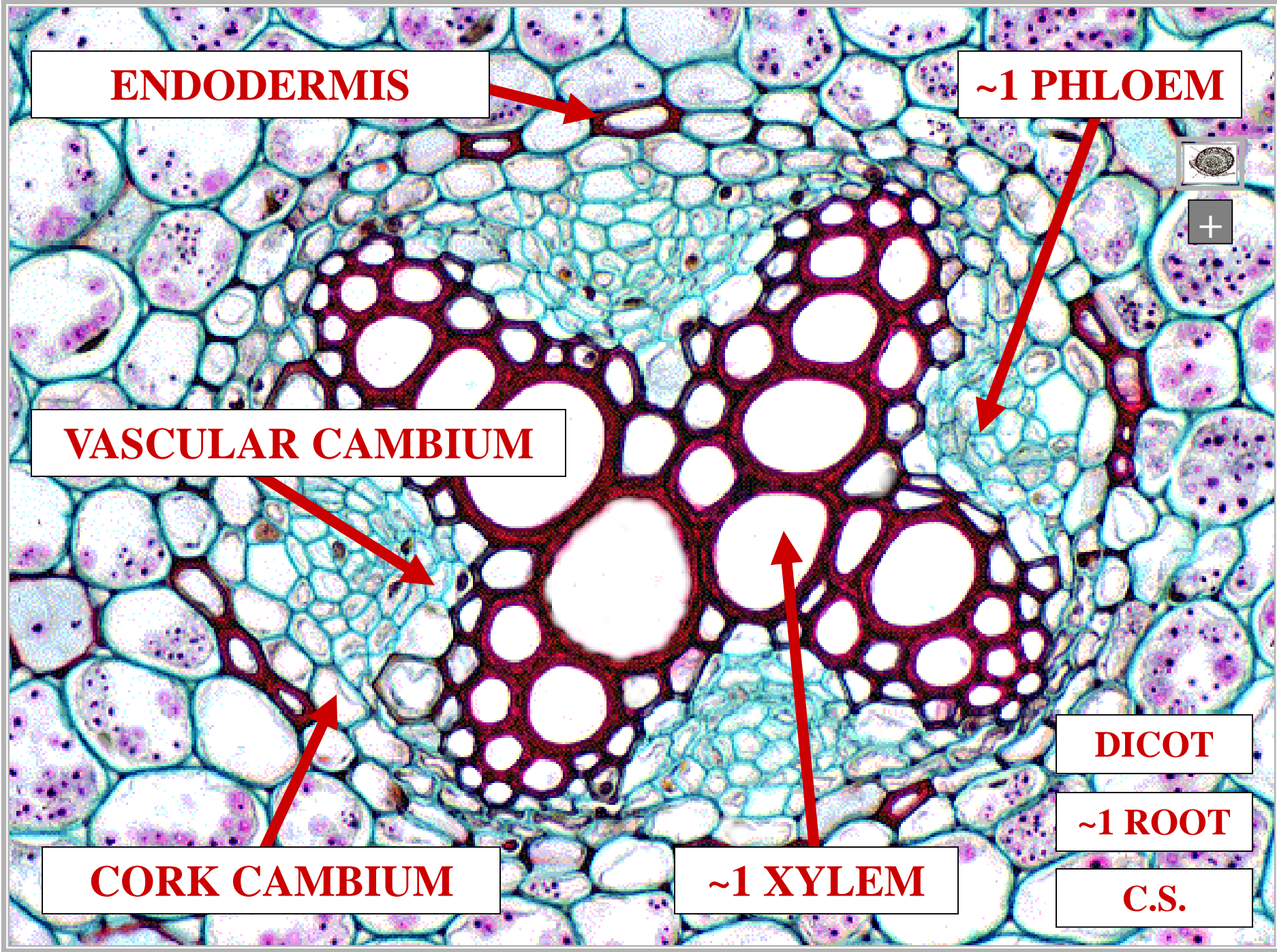

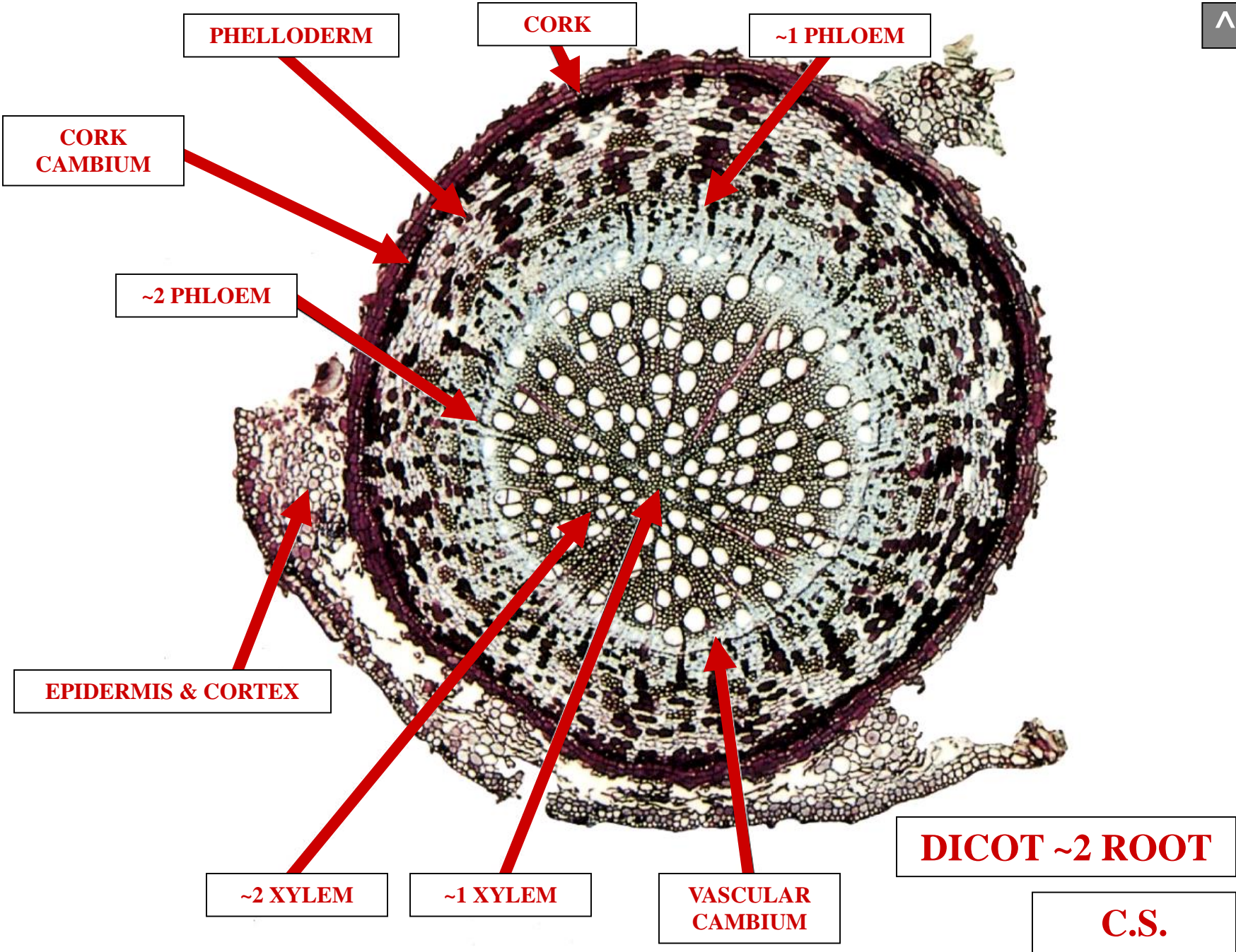



VC

CORK CAMBIUM INITIALS

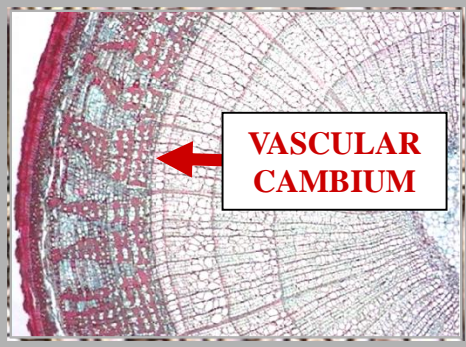

**VASCULAR
CAMBIUM**

**RAY
INITIALS**

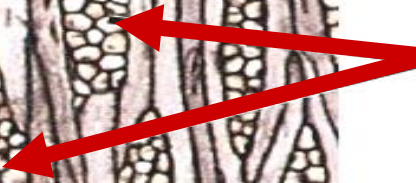

**FUSIFORM
INITIALS**

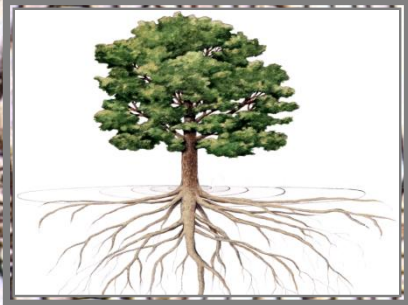

VASCULAR CAMBIUM

L.S.

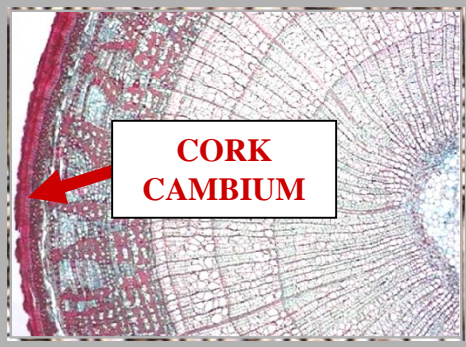

**CORK
CAMBIUM**



**RAY
INITIALS**

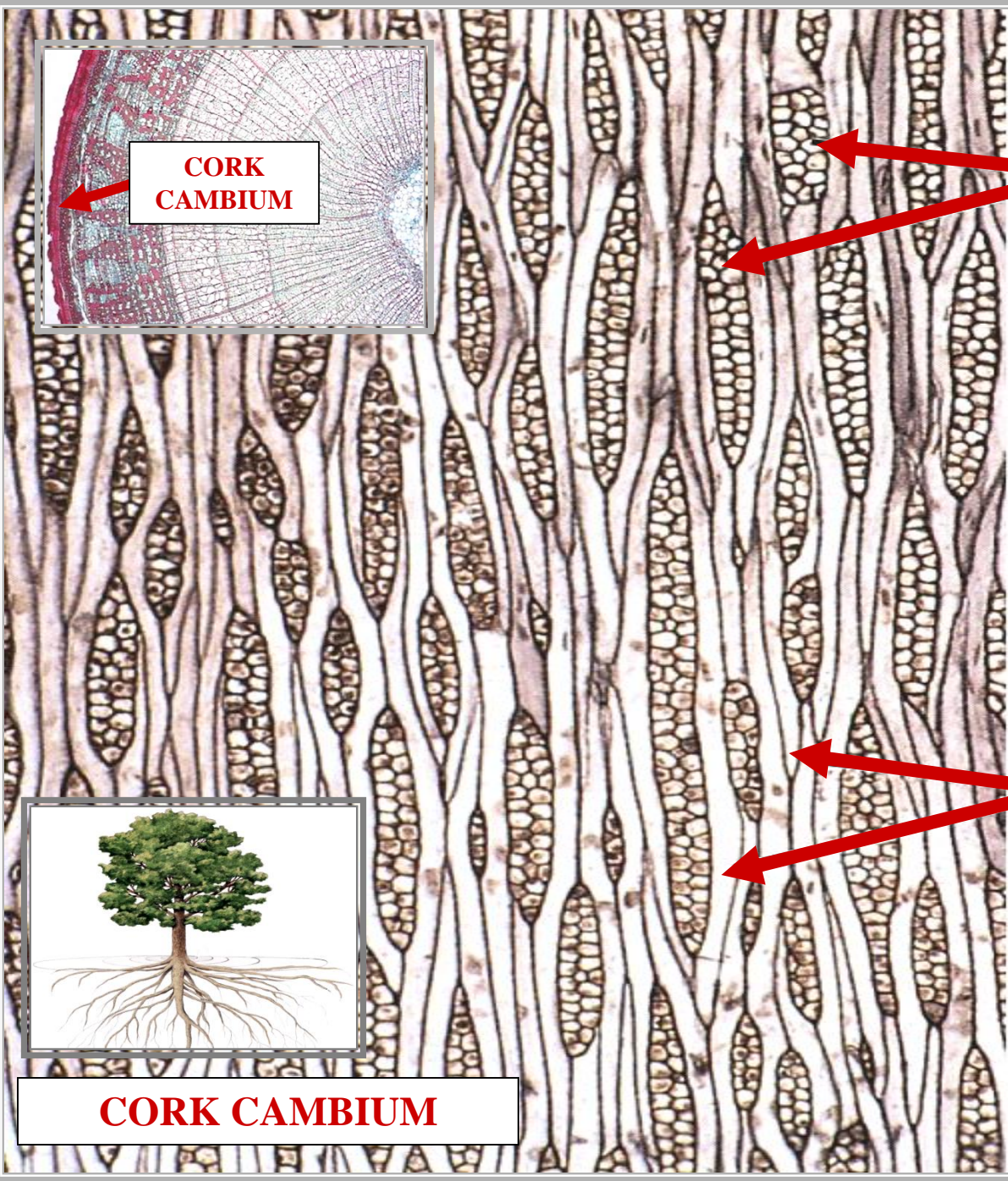

**FUSIFORM
INITIALS
ONLY**

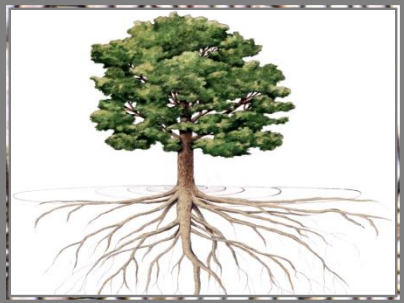

CORK CAMBIUM

L.S.



CORK CAMBIUM ACTIVITY

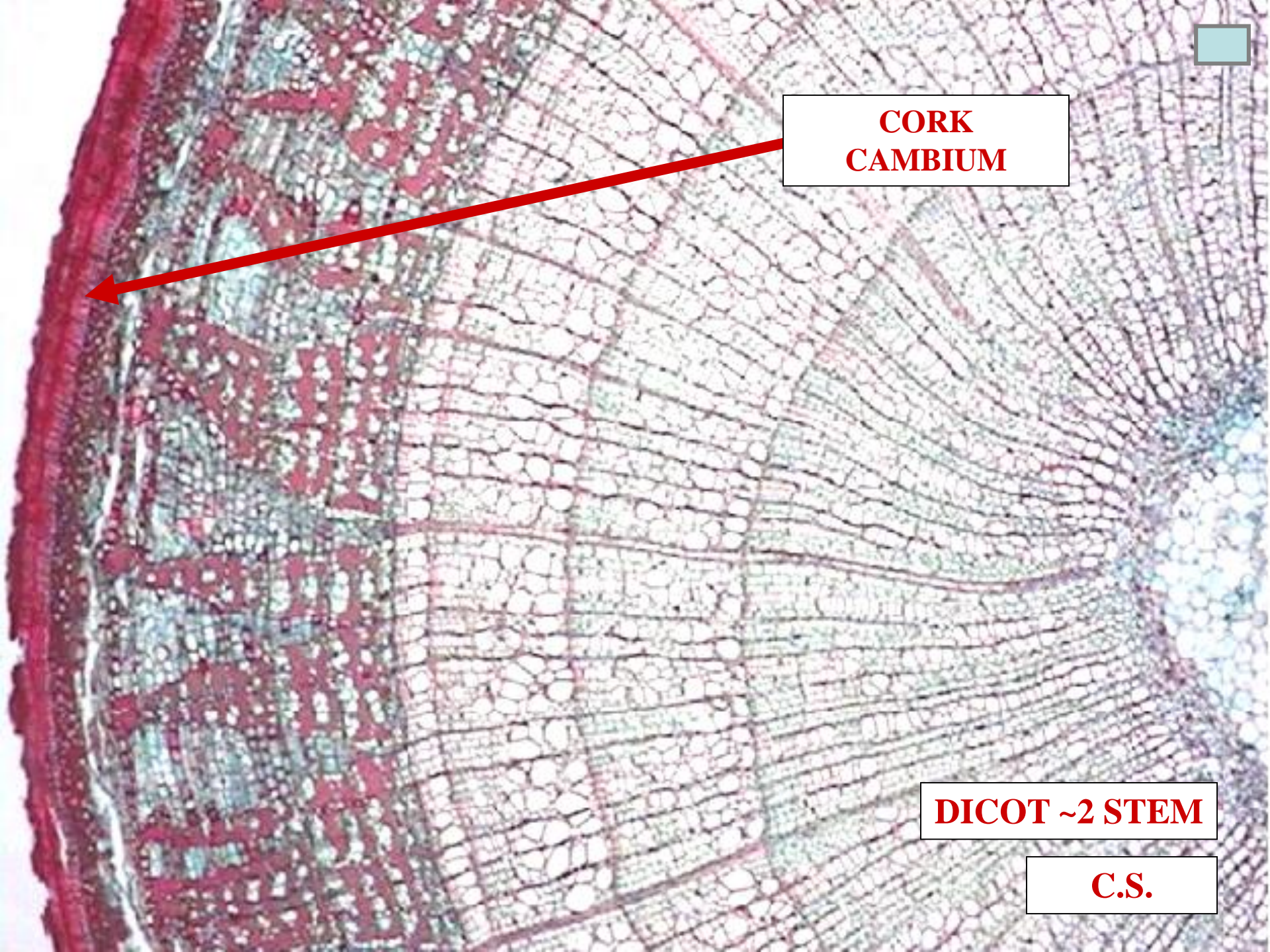

**CORK
CAMBIUM**

DICOT ~2 STEM

C.S.

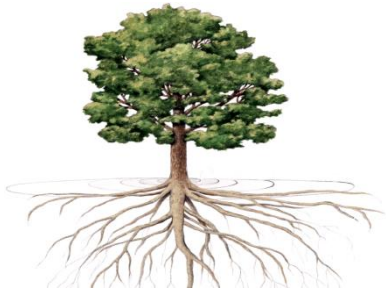

CELL

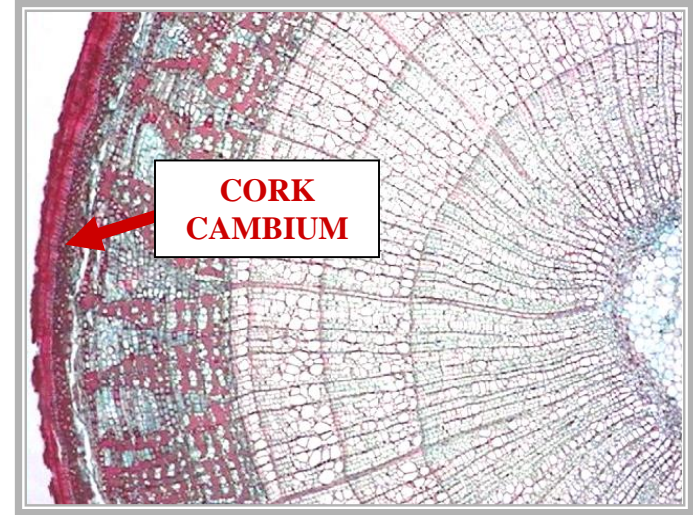

**CORK
CAMBIUM**

**CORK
CAMBIUM**

**CORK
CAMBIUM**

PC

DICOT ~ 2 STEM

C.S.



**PARENCHYMA
CELL INITIALS**

DICOT ~ 2 STEM

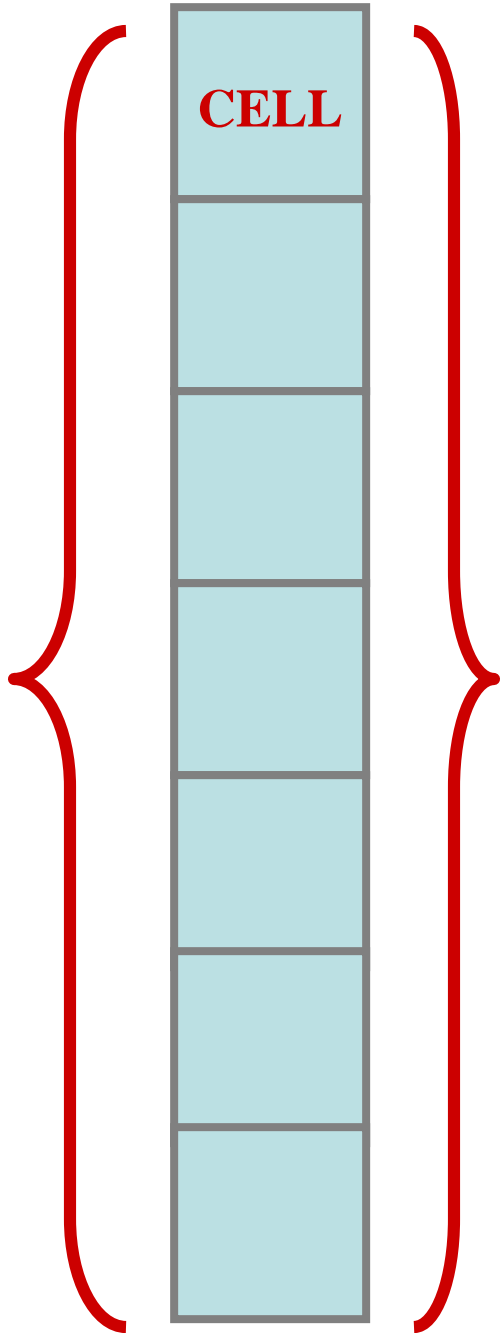

CELL

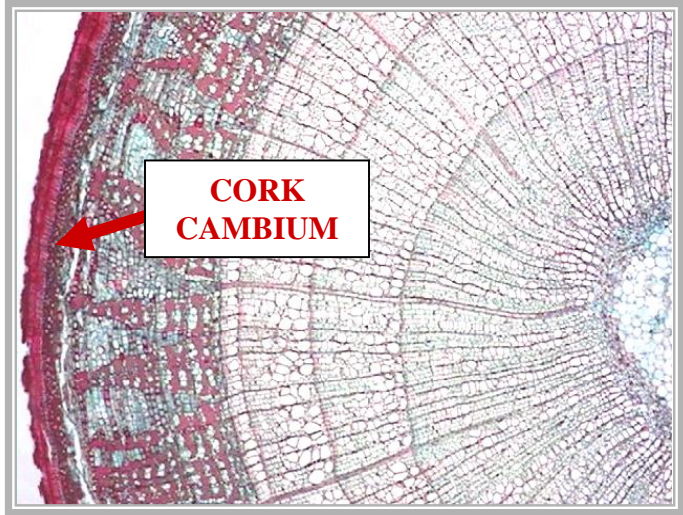

**PARENCHYMA
CELL INITIALS**

M

C.S.



CELL

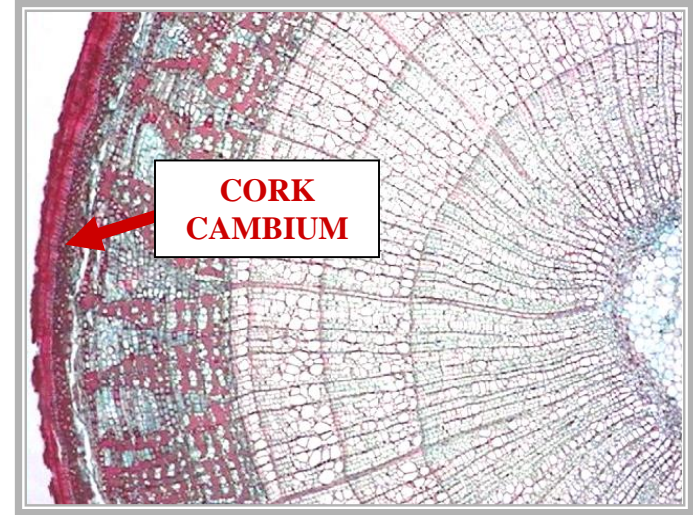

**CORK
CAMBIUM**

MITOSIS

MITOSIS

DICOT ~ 2 STEM

C.S.



**OUTSIDE
CORK
CAMBIUM**

**INSIDE
CORK
CAMBIUM**

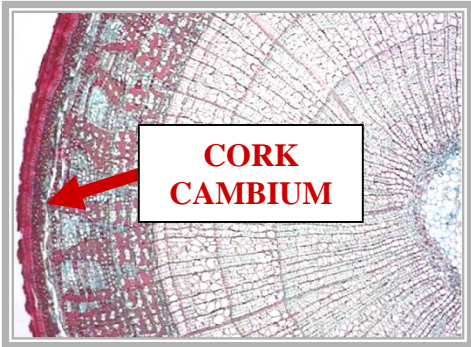
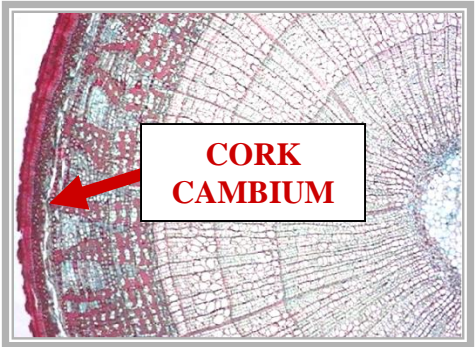

OUTSIDE

**DERIVATIVE
PARENCHYMA
CELLS**

DICOT ~ 2 STEM

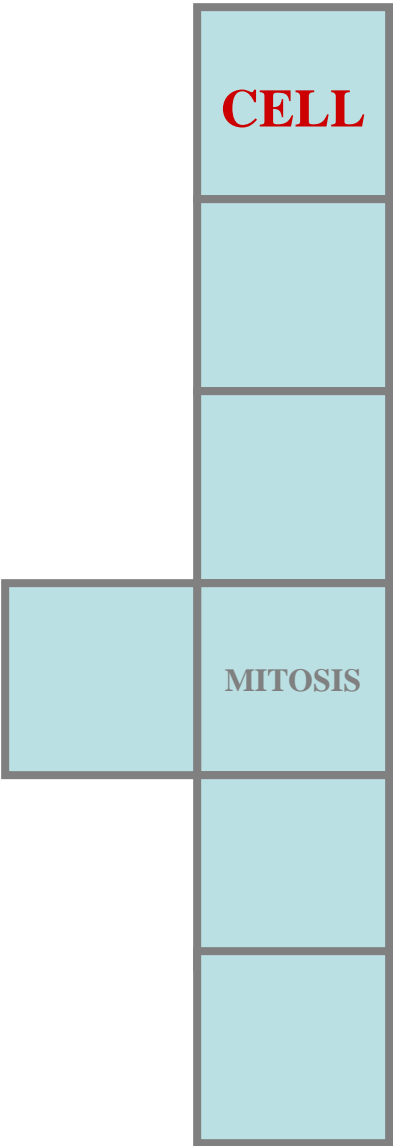

**CORK
CAMBIUM**

C.S.

**OUTSIDE
CORK
CAMBIUM**

**INSIDE
CORK
CAMBIUM**

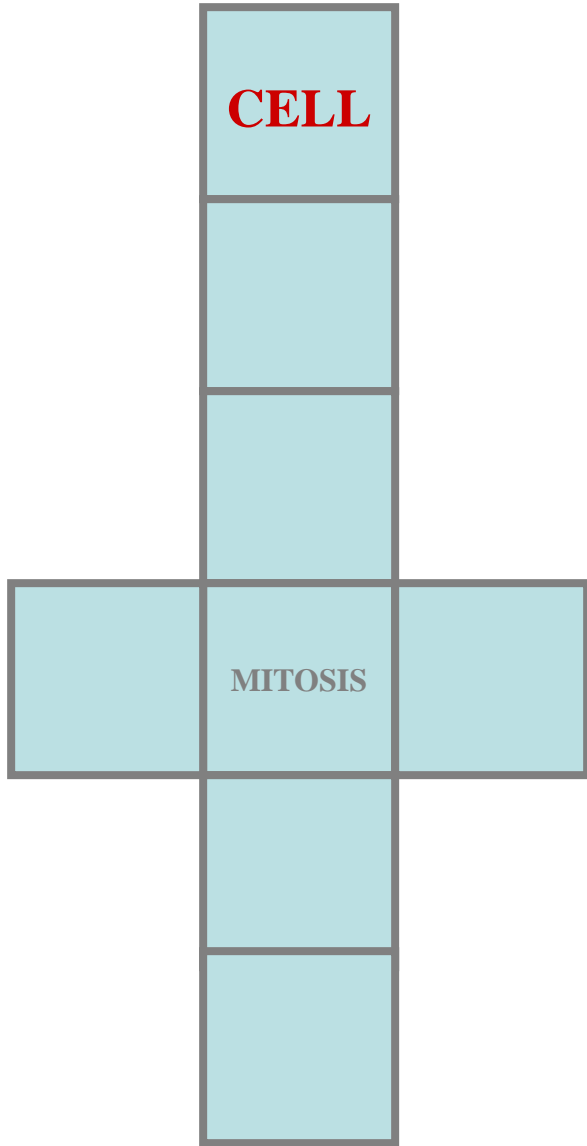
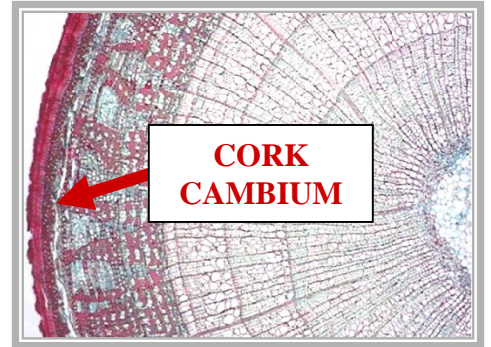
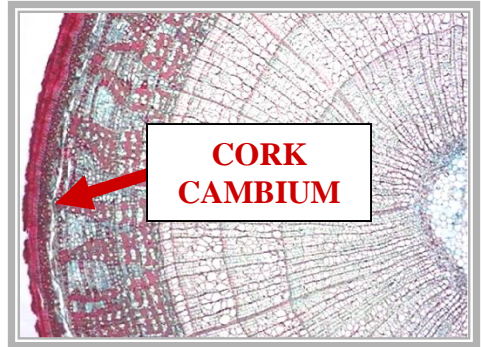

OUTSIDE

INSIDE

**DERIVATIVE
PARENCHYMA
CELLS**

**DERIVATIVE
PARENCHYMA
CELLS**

DICOT ~ 2 STEM

**CORK
CAMBIUM**

C.S.

**OUTSIDE
CORK
CAMBIUM**

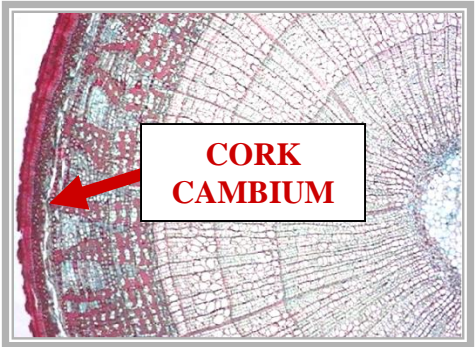

**INSIDE
CORK
CAMBIUM**

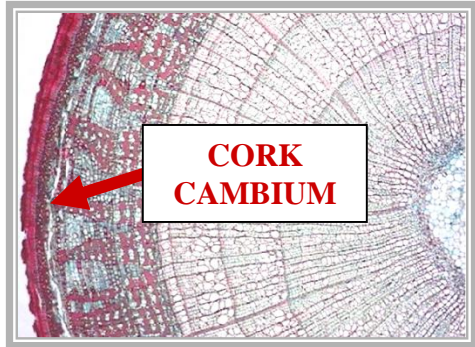

OUTSIDE

**DERIVATIVE
PARENCHYMA
CELLS**

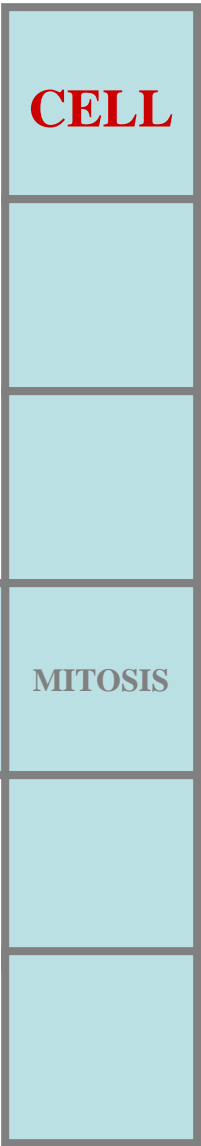
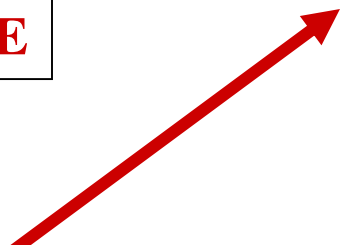

DICOT ~ 2 STEM

**CORK
CAMBIUM**

C.S.

**OUTSIDE
CORK
CAMBIUM**

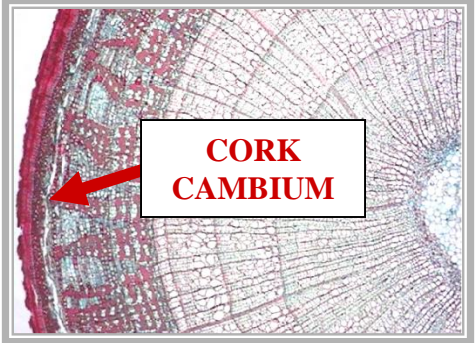

**INSIDE
CORK
CAMBIUM**

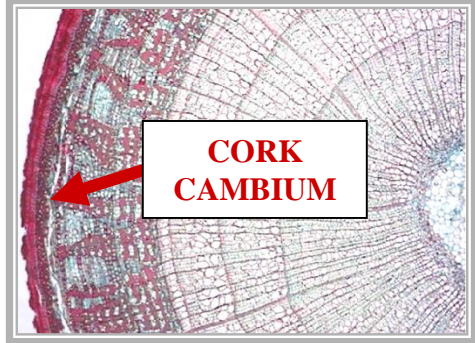

OUTSIDE

DIFFERENTIATE

DICOT ~ 2 STEM

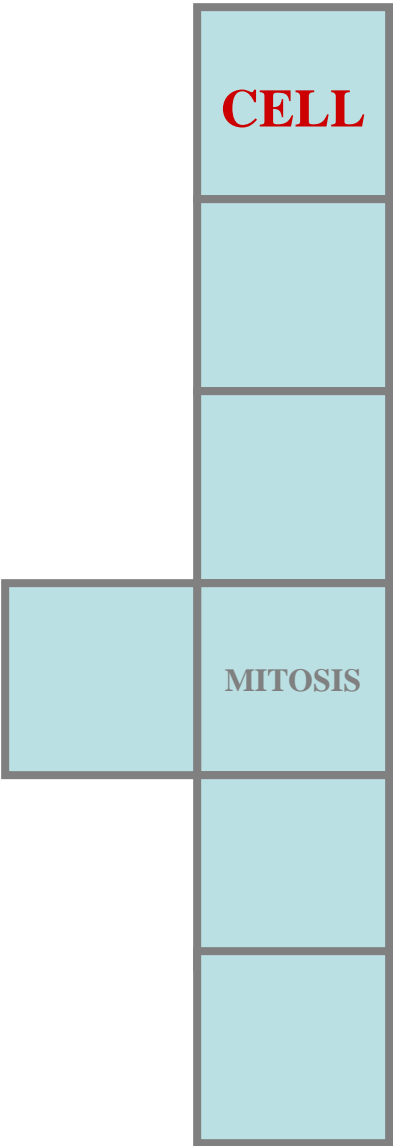

**CORK
CAMBIUM**

C.S.

**OUTSIDE
CORK
CAMBIUM**

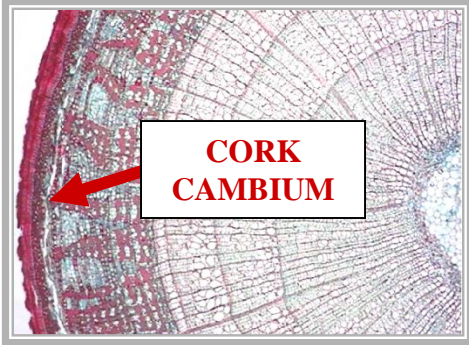

**CORK
CAMBIUM**

OUTSIDE

CORK

DICOT ~ 2 STEM

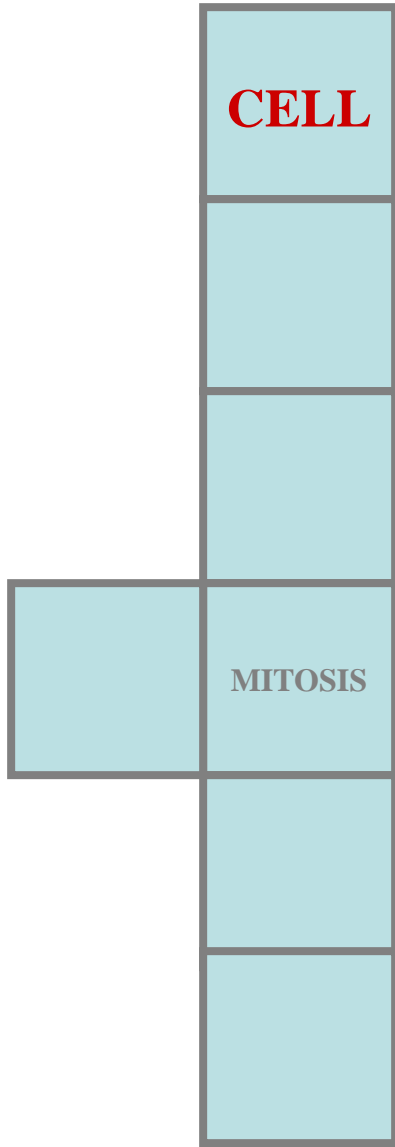

**CORK
CAMBIUM**

**INSIDE
CORK
CAMBIUM**

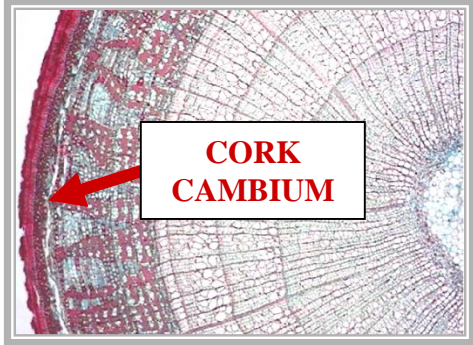

**CORK
CAMBIUM**

C.S.

**OUTSIDE
CORK
CAMBIUM**

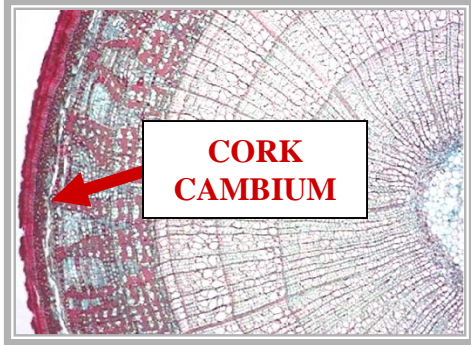

CELL

**INSIDE
CORK
CAMBIUM**

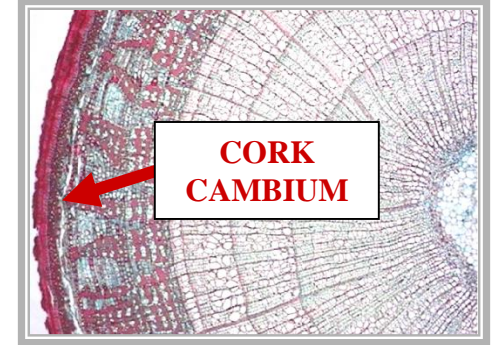

I
→

MITOSIS

OUTSIDE

**CORK
HIGH ANNUAL
QUANTITY**

DICOT ~ 2 STEM

**CORK
CAMBIUM**

C.S.

**OUTSIDE
CORK
CAMBIUM**

**INSIDE
CORK
CAMBIUM**

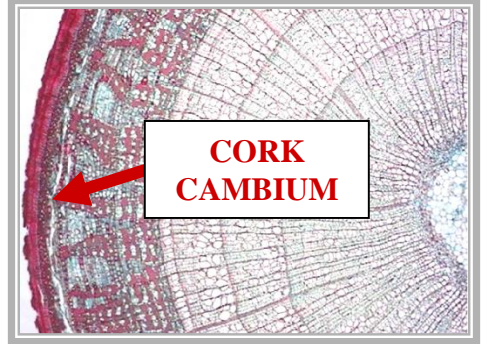
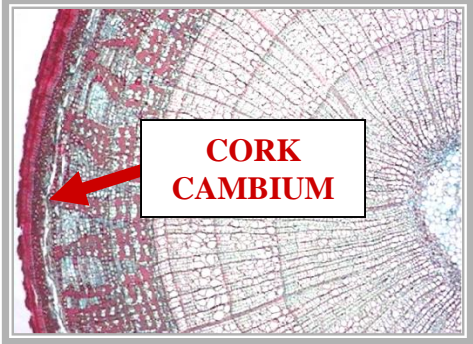

OUTSIDE

INSIDE

**CORK
HIGH ANNUAL
QUANTITY**

**DERIVATIVE
PARENCHYMA
CELLS**

DICOT ~ 2 STEM

**CORK
CAMBIUM**

C.S.

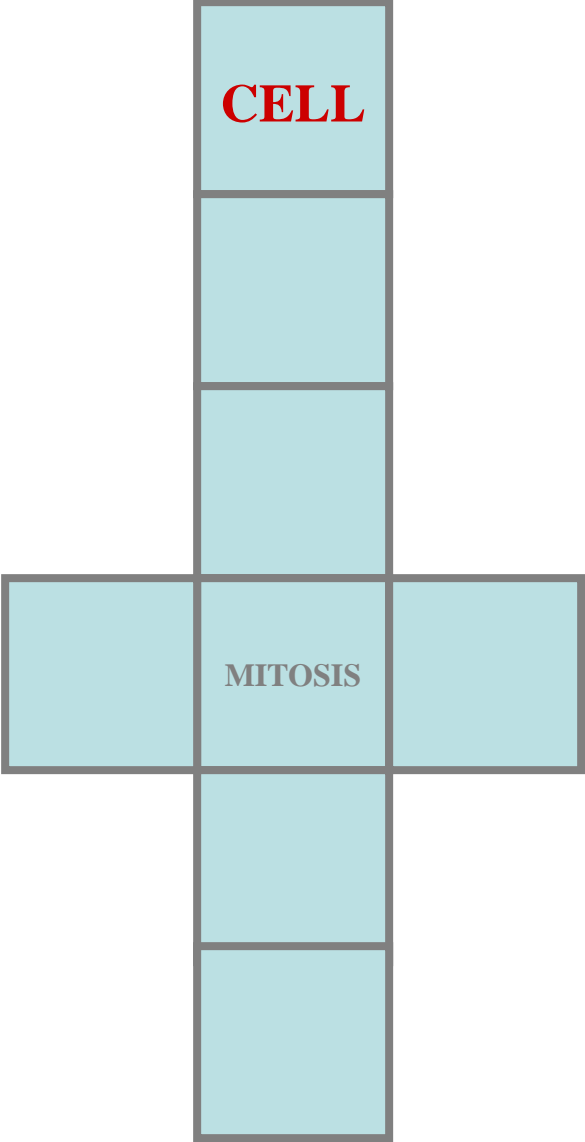

**OUTSIDE
CORK
CAMBIUM**

**INSIDE
CORK
CAMBIUM**

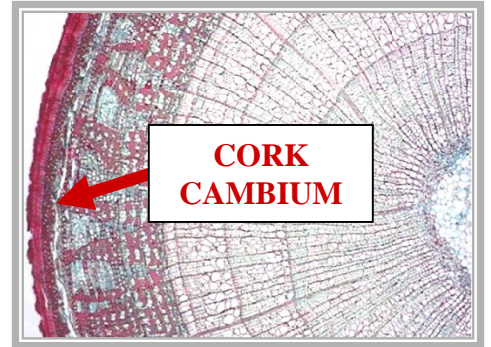
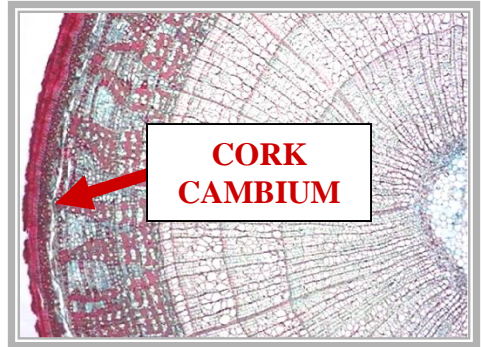

**CORK
CAMBIUM**

**CORK
CAMBIUM**

OUTSIDE

INSIDE

**CORK
HIGH ANNUAL
QUANTITY**

DIFFERENTIATE

DICOT ~ 2 STEM

**CORK
CAMBIUM**

C.S.

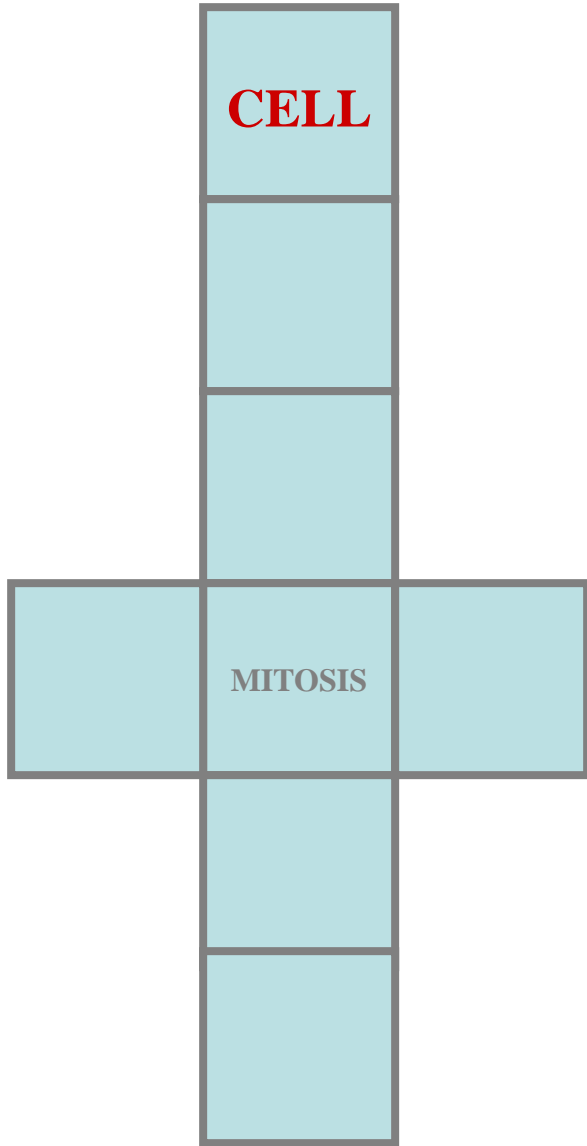

**OUTSIDE
CORK
CAMBIUM**

**INSIDE
CORK
CAMBIUM**

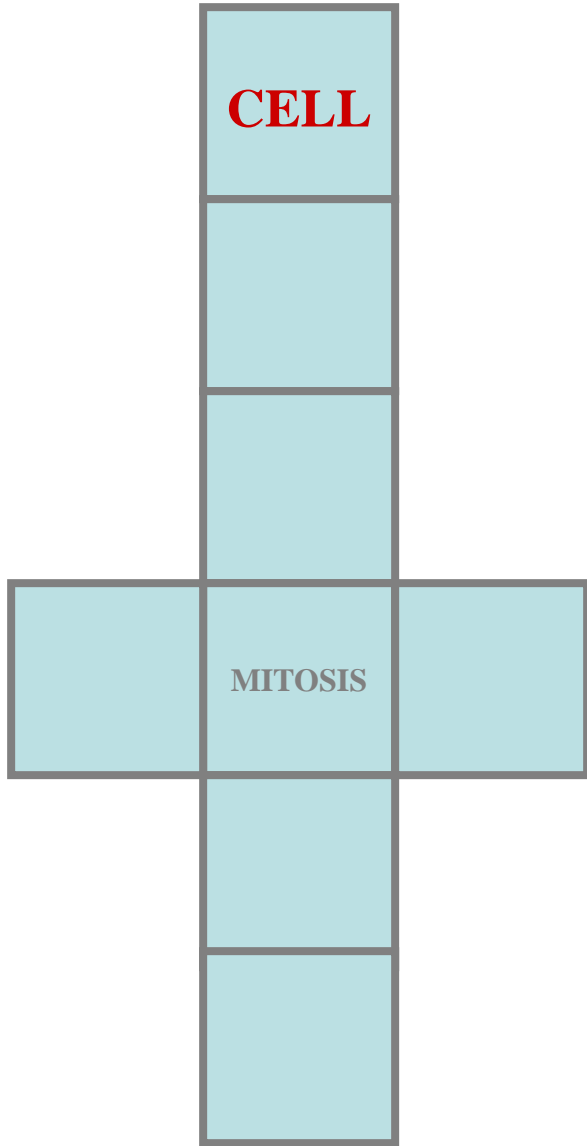
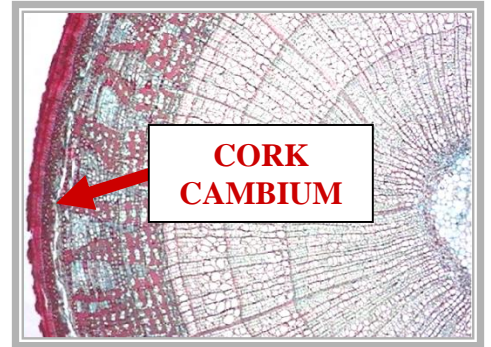
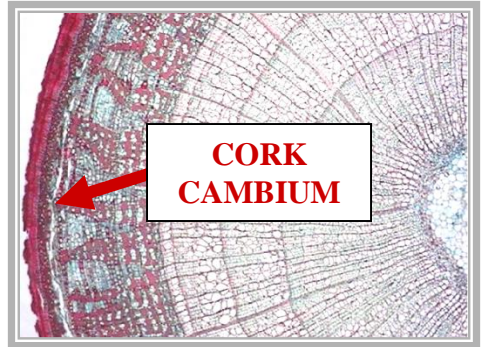

OUTSIDE

INSIDE

**CORK
HIGH ANNUAL
QUANTITY**

PHELLODERM

DICOT ~ 2 STEM

**CORK
CAMBIUM**

C.S.

**OUTSIDE
CORK
CAMBIUM**

**INSIDE
CORK
CAMBIUM**

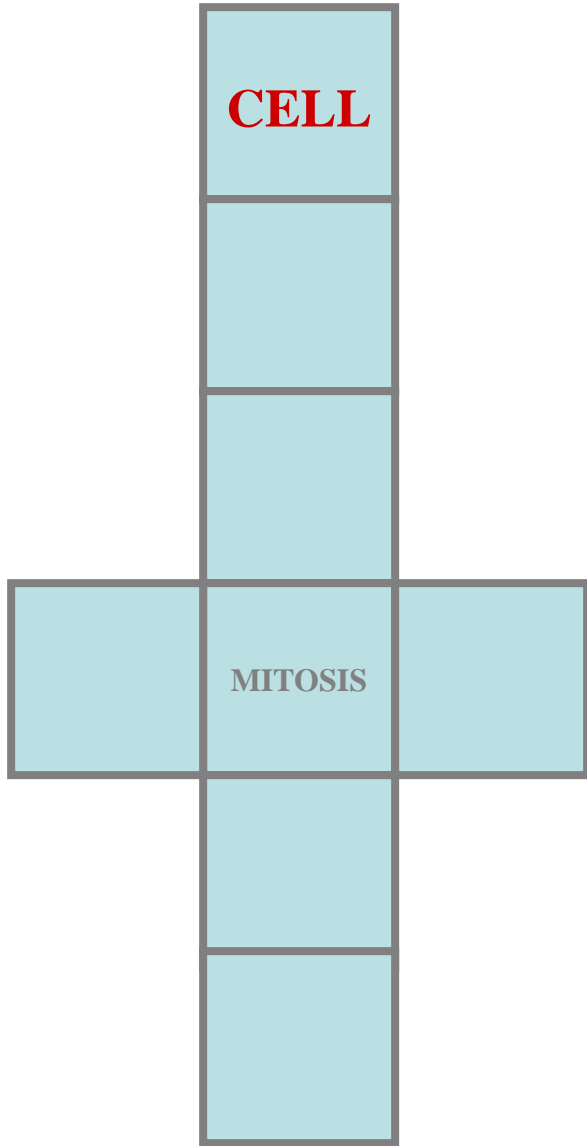
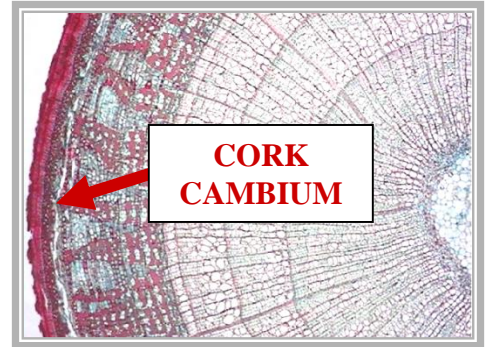
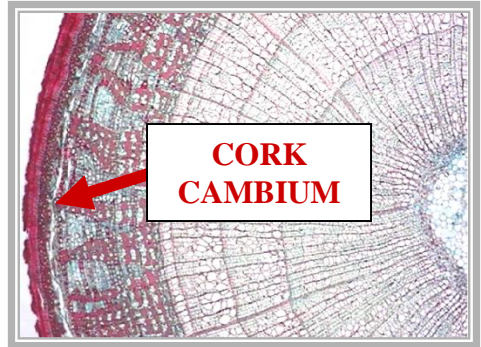

OUTSIDE

INSIDE

**CORK
HIGH ANNUAL
QUANTITY**

**PHELLODERM
LOW ANNUAL
QUANTITY**

DICOT ~ 2 STEM

**CORK
CAMBIUM**

C.S.

CORK
CAMBIIUM
ACTIVITY
EXAMPLE

DICOT ~2 STEM

CC

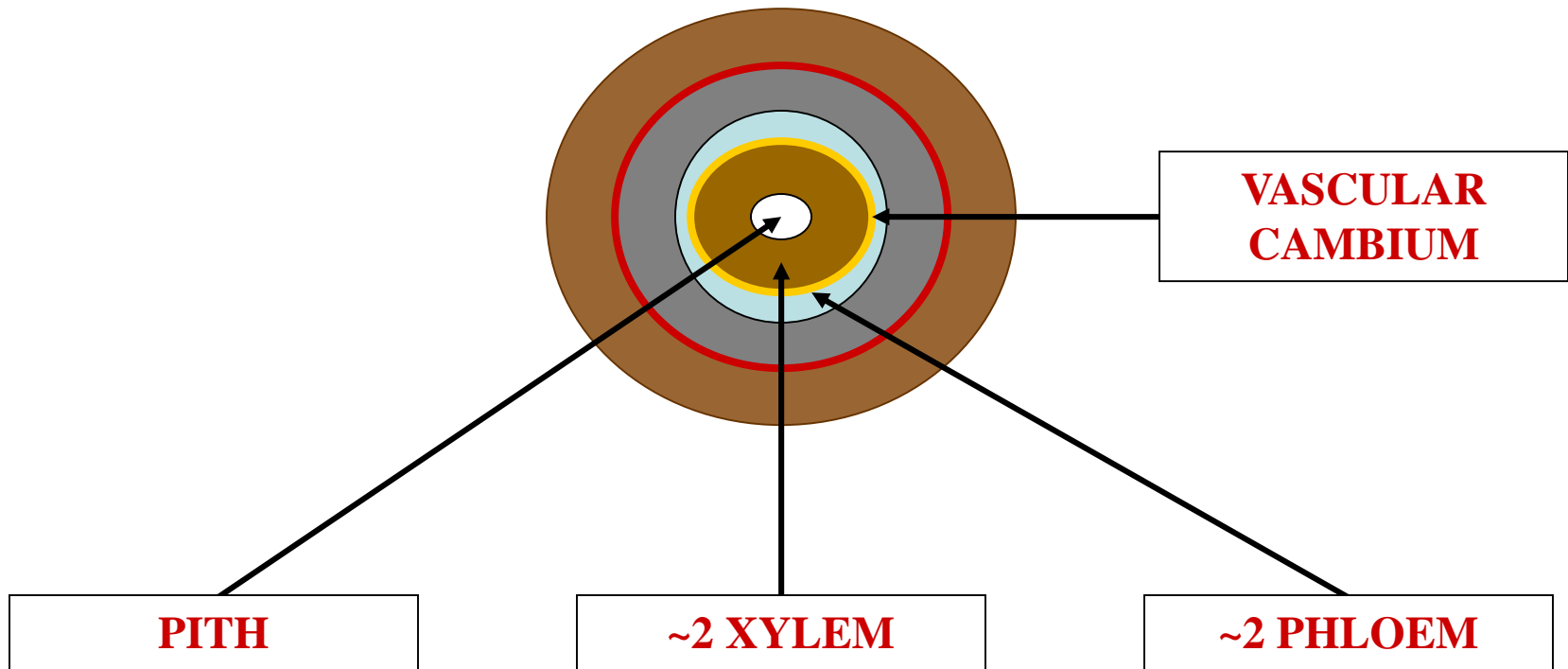

CORK CAMBIUM ACTIVITY

C.S.

DICOT ~2 STEM

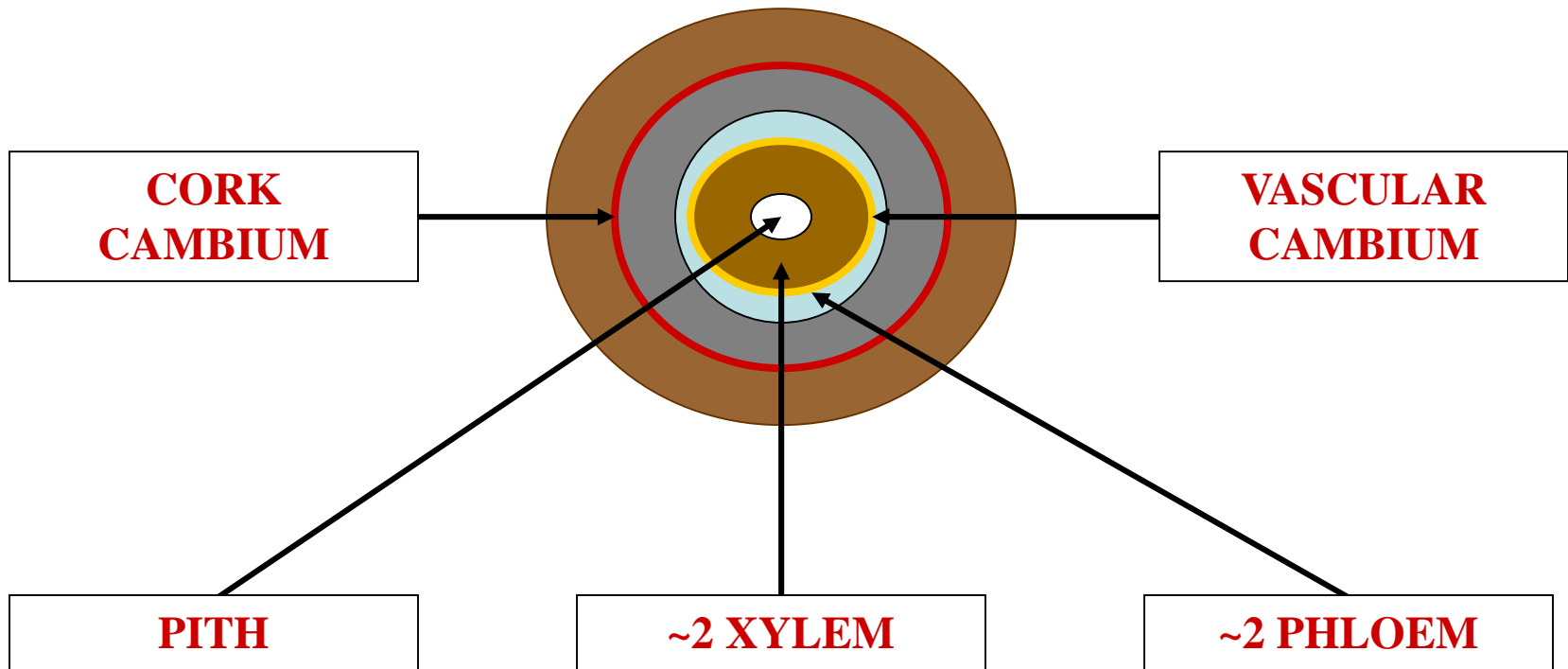

CORK CAMBIUM ACTIVITY

C.S.

DICOT ~2 STEM

C



?

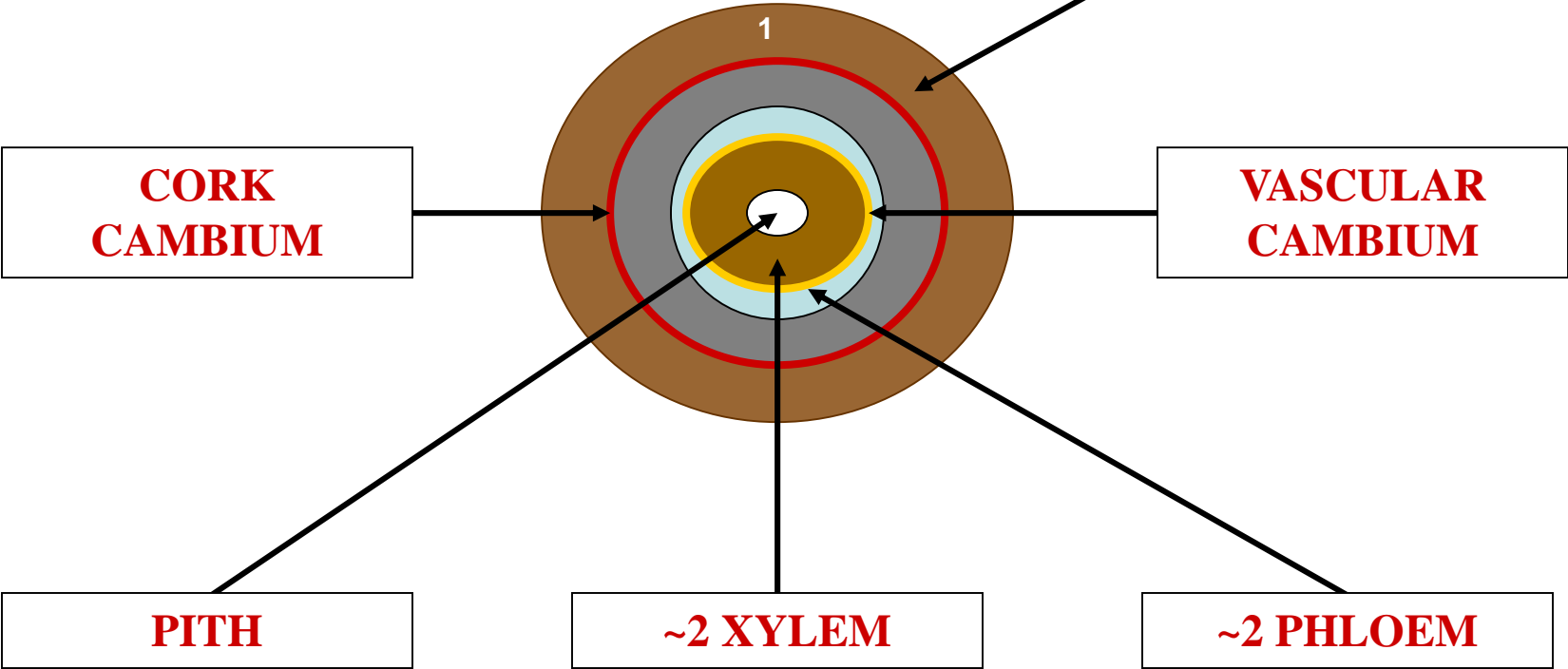

CORK CAMBIUM ACTIVITY

C.S.

DICOT ~2 STEM

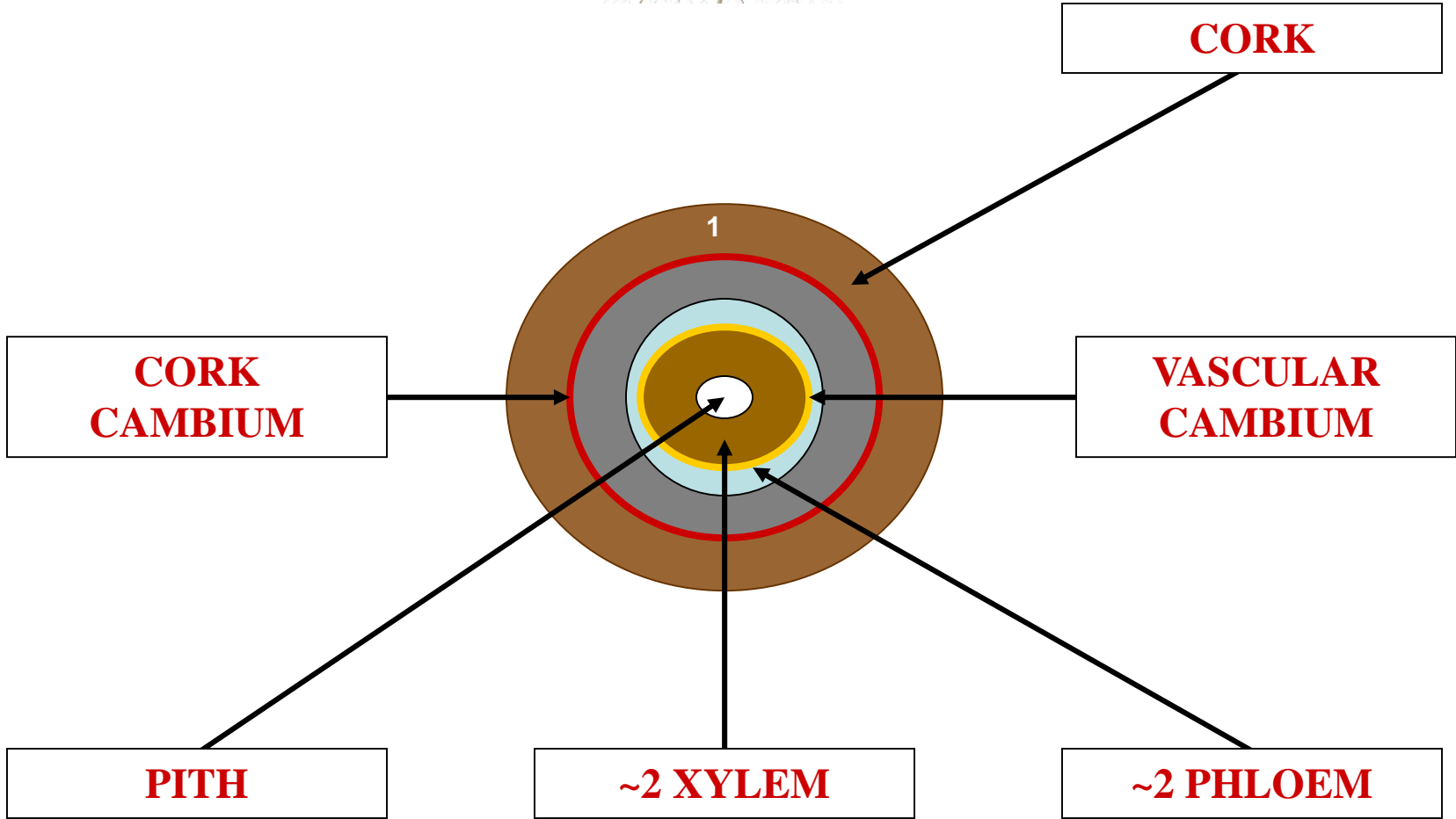

CORK CAMBIUM

CORK

VASCULAR CAMBIUM

PITH

~2 XYLEM

~2 PHLOEM

CORK CAMBIUM ACTIVITY

C.S.

DICOT ~2 STEM



?

CORK

**CORK
CAMBIUM**

**VASCULAR
CAMBIUM**

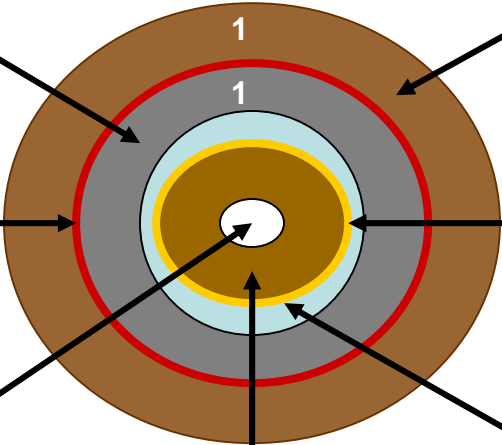

PITH

~2 XYLEM

~2 PHLOEM

CORK CAMBIUM ACTIVITY

C.S.