



ATTENTION STUDENTS



BIOLOGY 463

PLANT TAXONOMY

DR. MENAPACE

SPRING 2023



ATTENTION STUDENTS



BIOLOGY 463

PLANT TAXONOMY

DR. MENAPACE

SPRING 2023



ATTENTION STUDENTS 

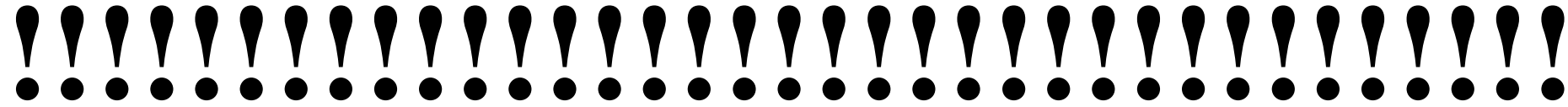

SCREEN #2

LECTURE SLIDES

NUCLEIC ACIDS



CARRIERS GENETIC INFORMATION

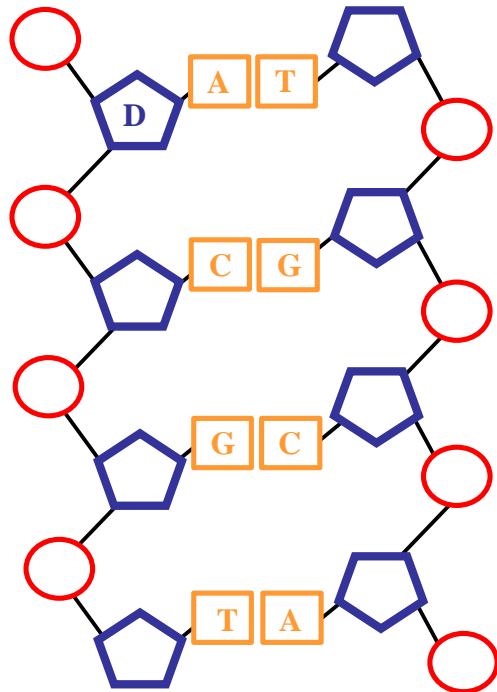

NUCLEIC ACID

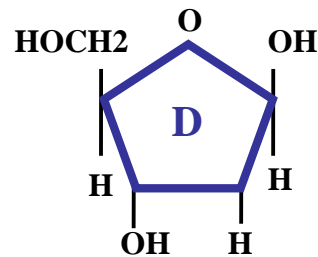

DEOXYRIBOSE

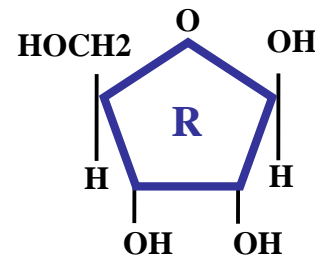

RIBOSE

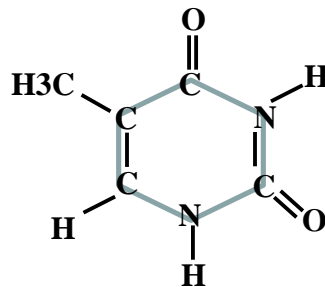

THYMINE

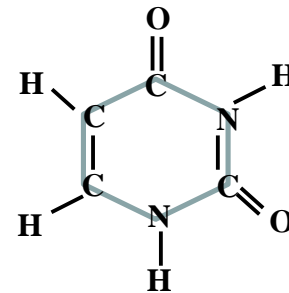

URACIL

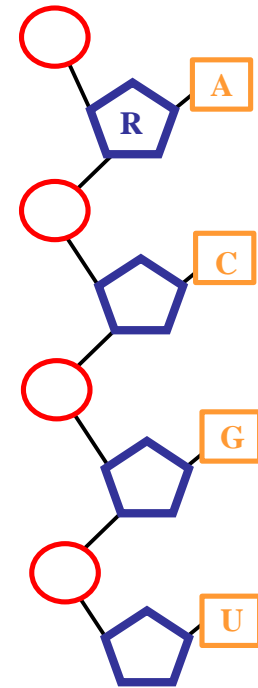

NUCLEIC ACID

**INTRODUCTION
BIOLOGY
&
INTRODUCTION
BOTANY**

INTRODUCTION BIOLOGY

BIOLOGY



BIOLOGY

**STUDY OF LIVING
ORGANISMS**

BIOLOGY

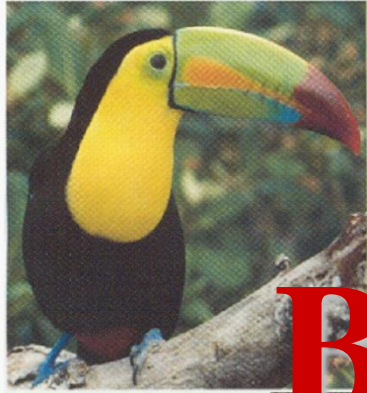

BIOLOGY

STUDY OF



LIVING ORGANISMS

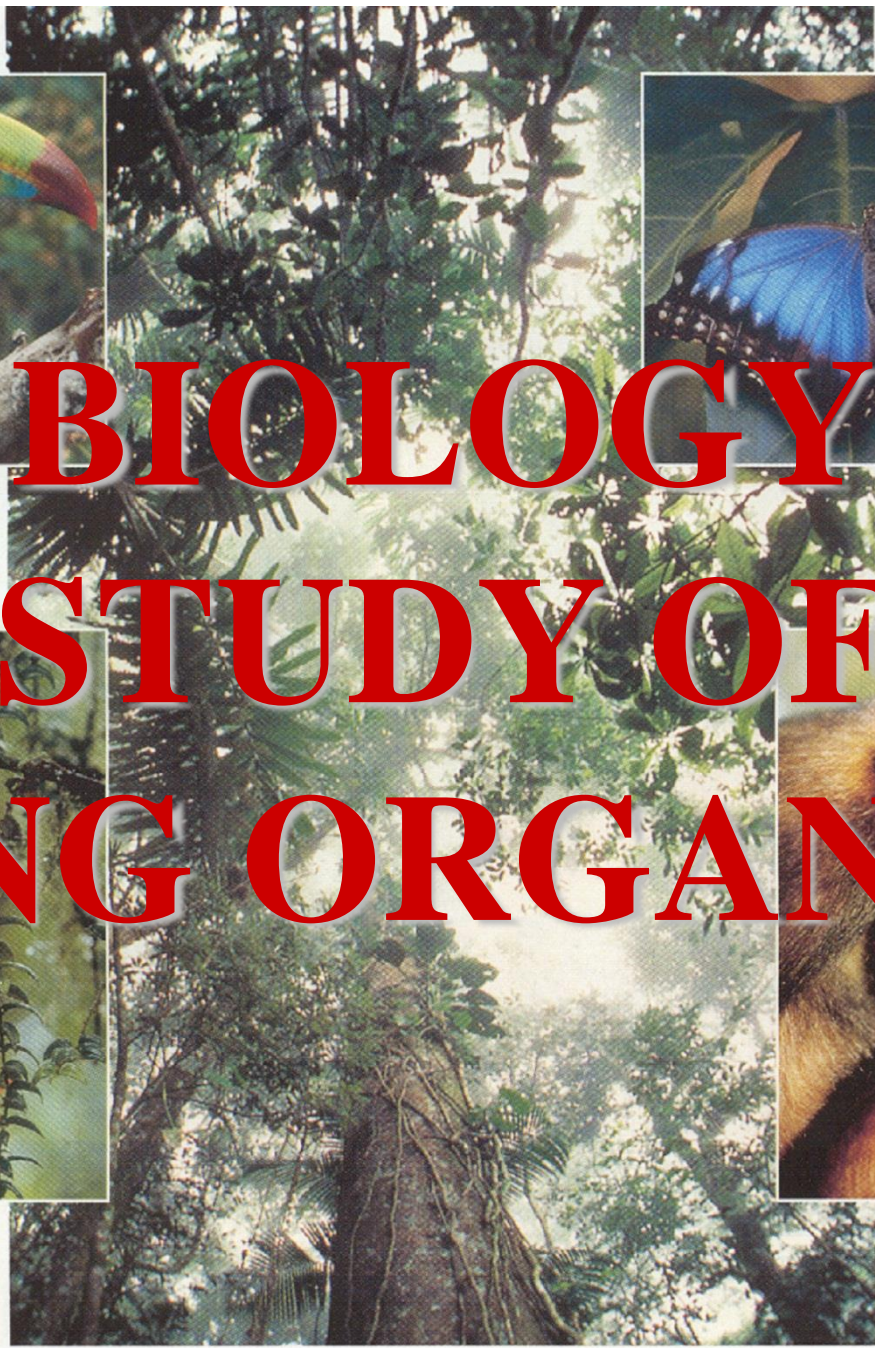



LIVING ORGANISM DEFINITION

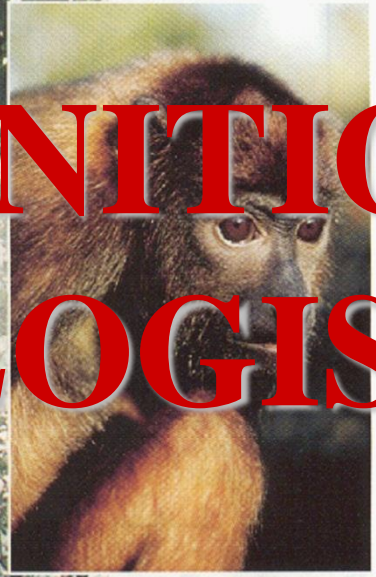
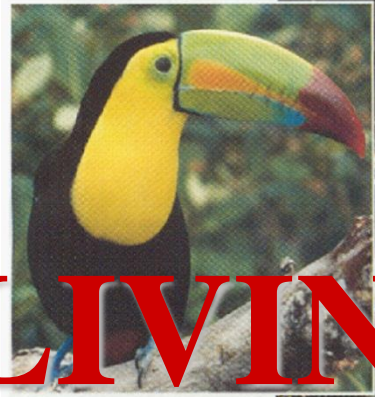

**LIVING ORGANISM
NO
COMMON DEFINITION
AMONGST BIOLOGISTS**

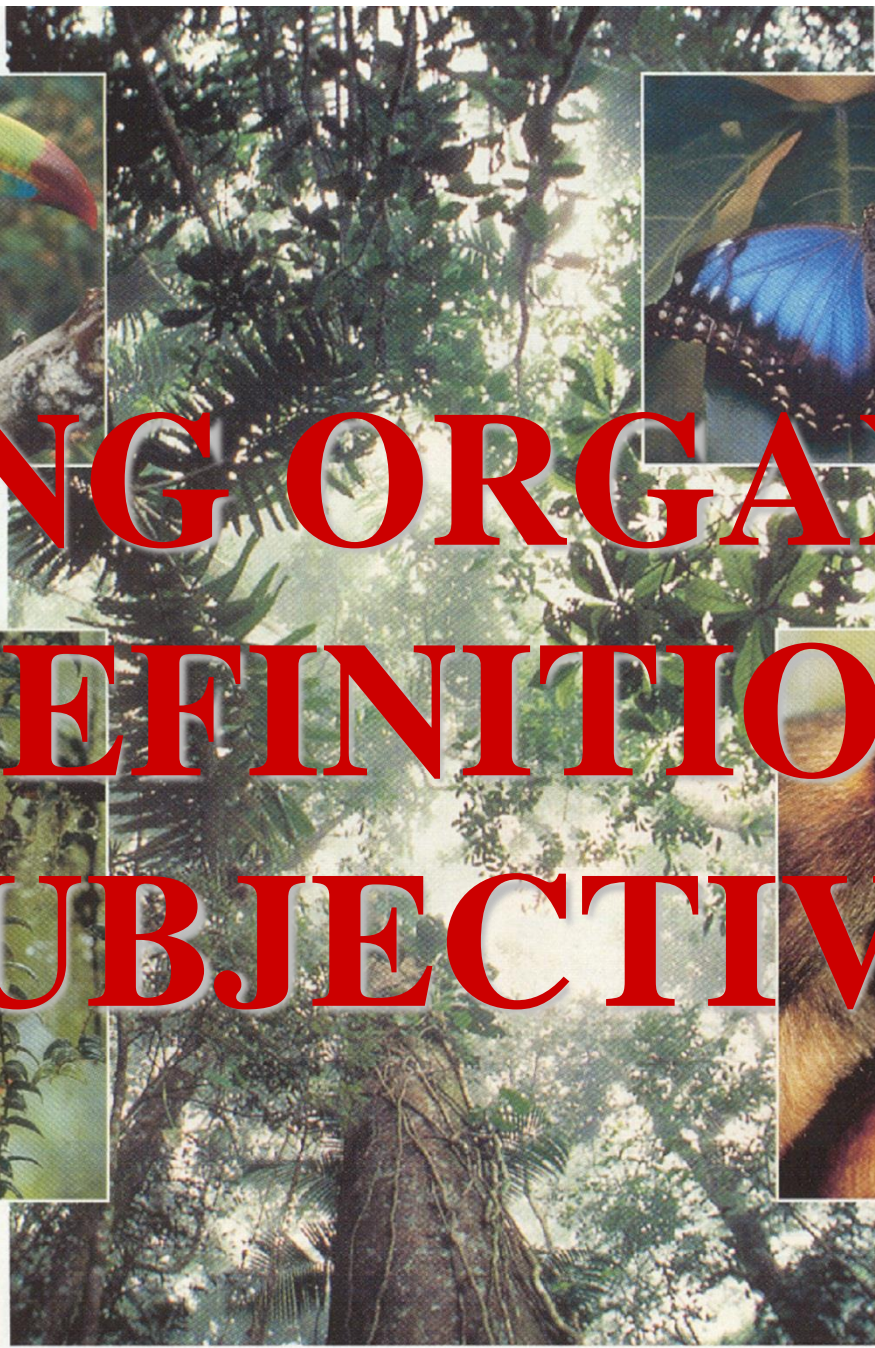
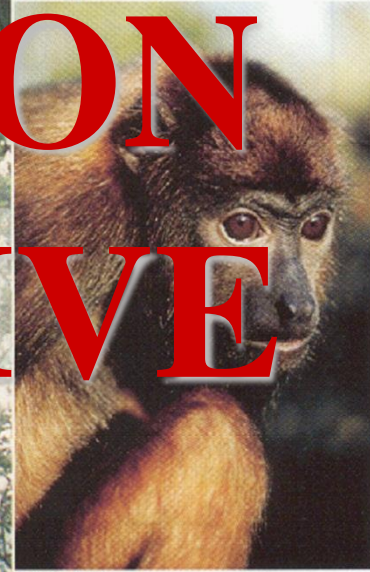
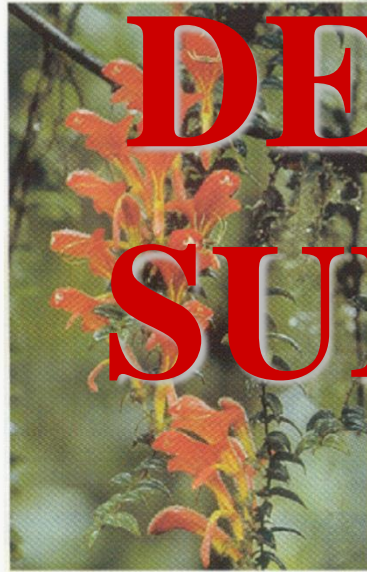

LIVING ORGANISM

DEFINITION

SUBJECTIVE

LIVING ORGANISM CLASS DEFINITION

LIVING ORGANISM

LIVING ORGANISM



**ENTITY WITH
FUNCTIONAL
NUCLEIC ACIDS**

LIVING ORGANISM



**LIVING ORGANISM
ENTITY WITH
FUNCTIONAL
NUCLEIC ACIDS**

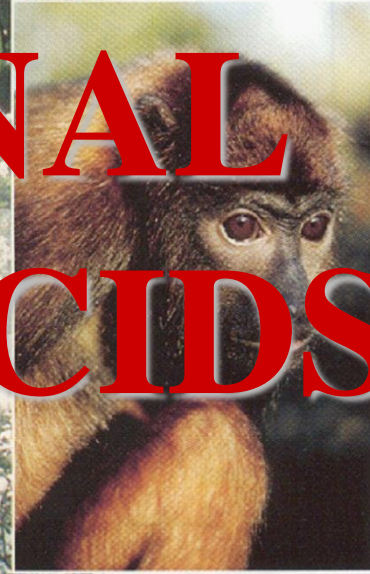

FUNCTIONAL NUCLEIC ACIDS

NUCLEIC ACIDS

NUCLEIC ACIDS



CARRIERS GENETIC
INFORMATION

NUCLEIC ACIDS

NUCLEIC ACIDS



CARRIERS GENETIC INFORMATION

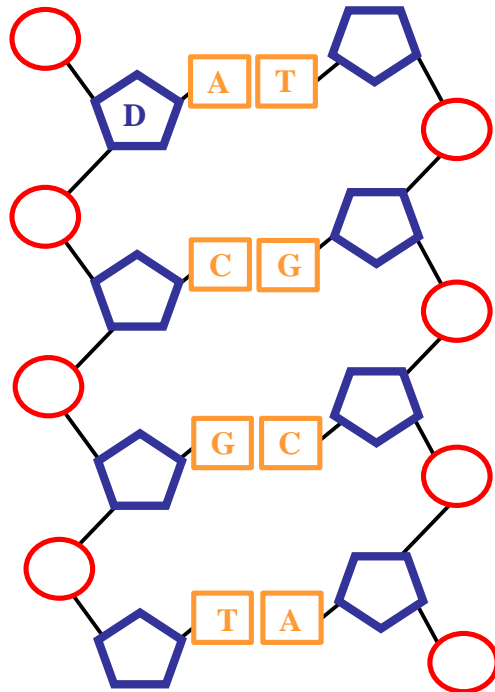

NUCLEIC ACID

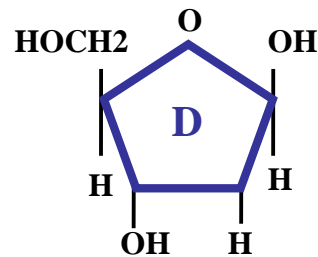

DEOXYRIBOSE

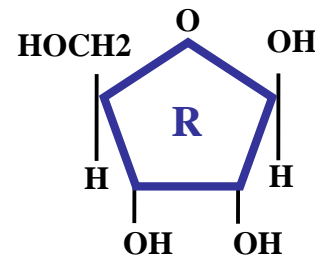

RIBOSE

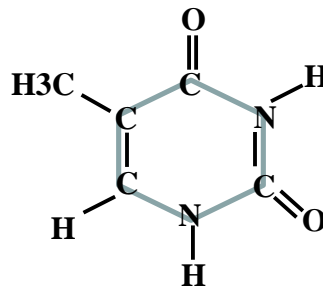

THYMINE

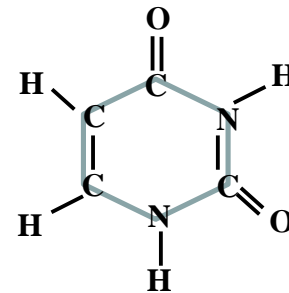

URACIL

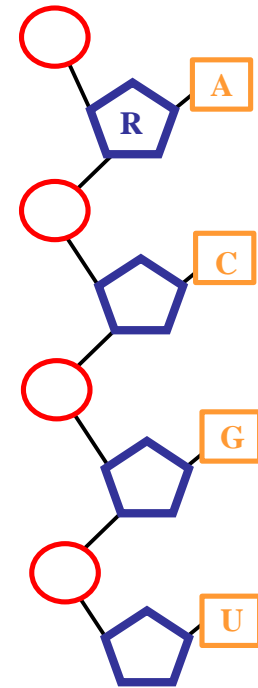

NUCLEIC ACID



NUCLEIC ACID TYPES

NUCLEIC ACIDS

L D

?

?

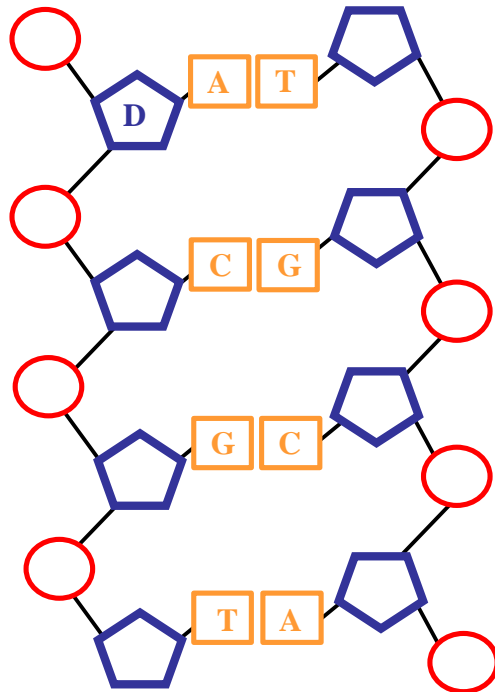

NUCLEIC ACID

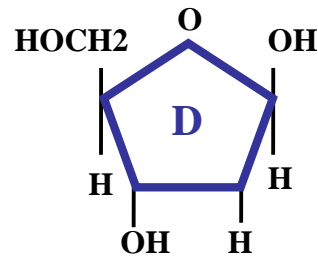

DEOXYRIBOSE

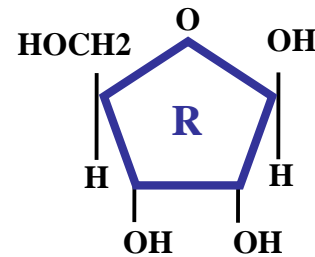

RIBOSE

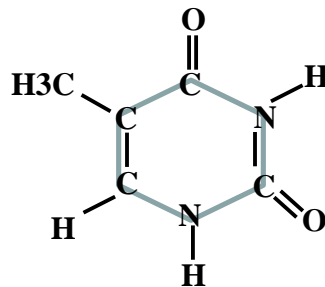

THYMINE

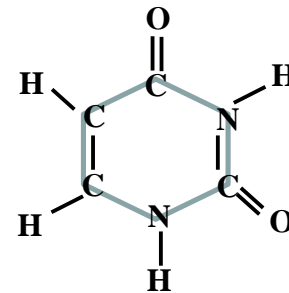

URACIL

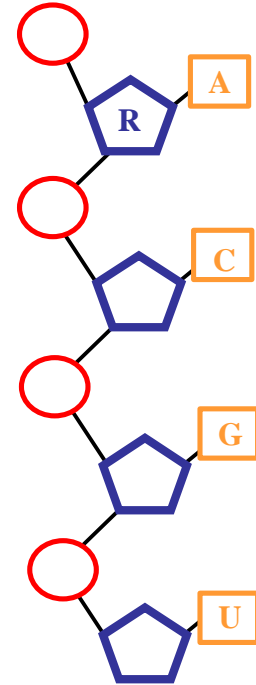

NUCLEIC ACID

NUCLEIC ACIDS

R

DNA

?

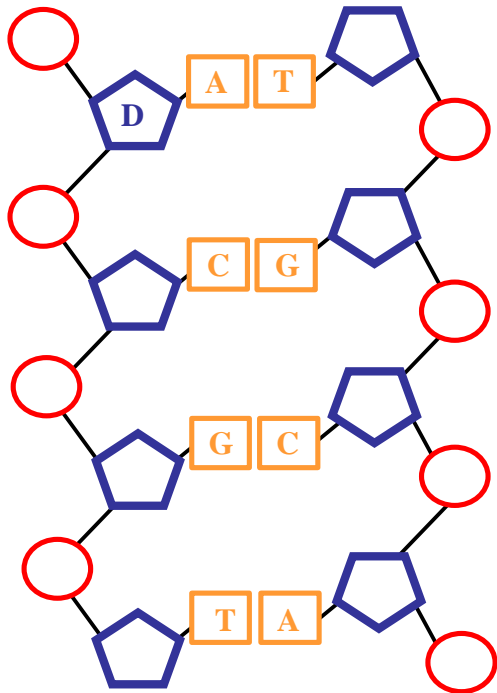

NUCLEIC ACID

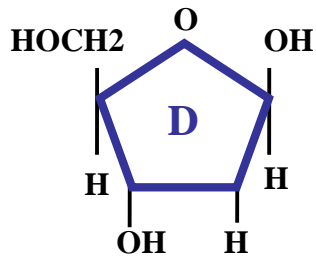

DEOXYRIBOSE

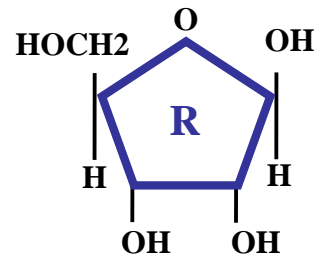

RIBOSE

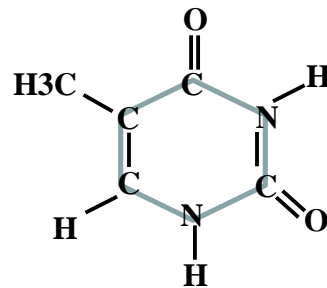

THYMINE

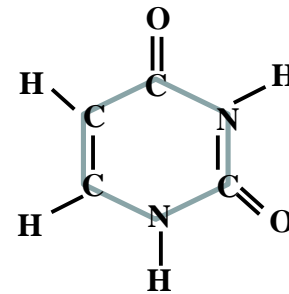

URACIL

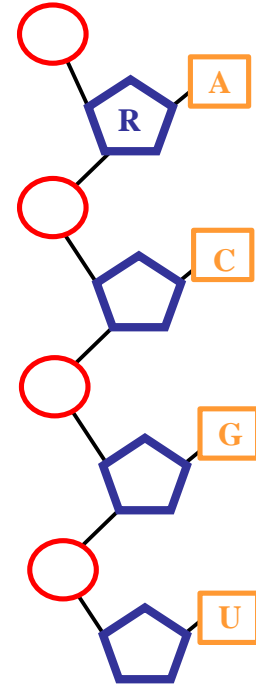

NUCLEIC ACID

NUCLEIC ACIDS



DNA

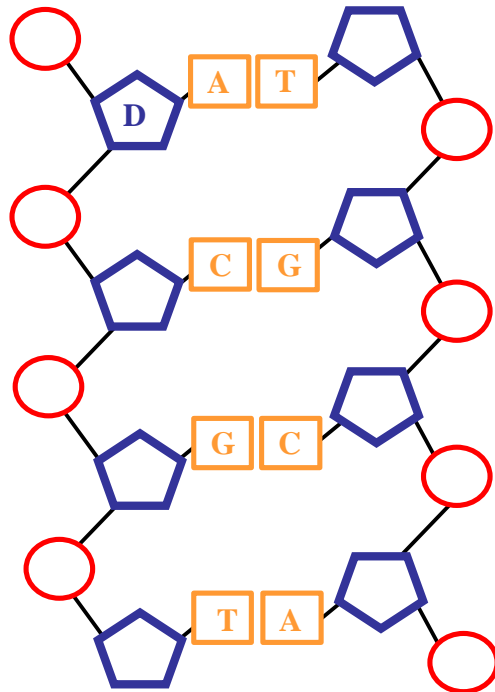

NUCLEIC ACID

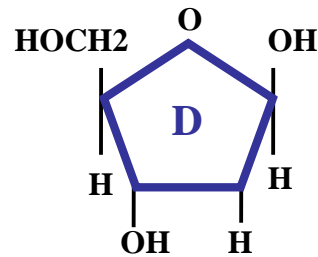

DEOXYRIBOSE

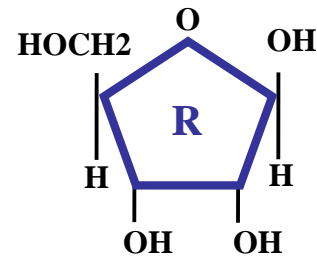

RIBOSE

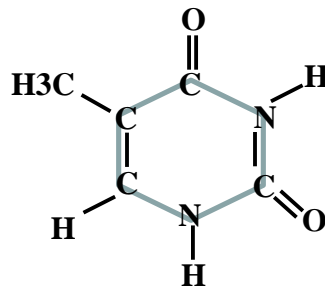

THYMINE

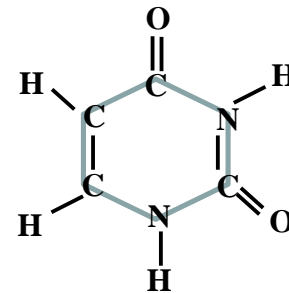

URACIL

RNA

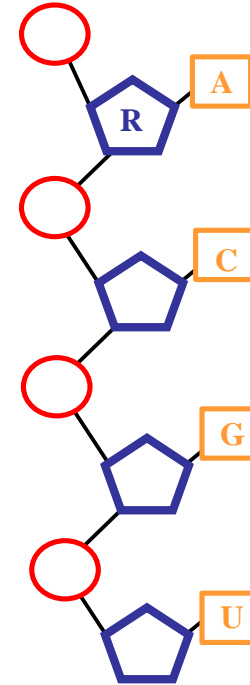

NUCLEIC ACID

NUCLEIC ACIDS

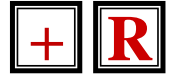

DEOXYRIBONUCLEIC ACID

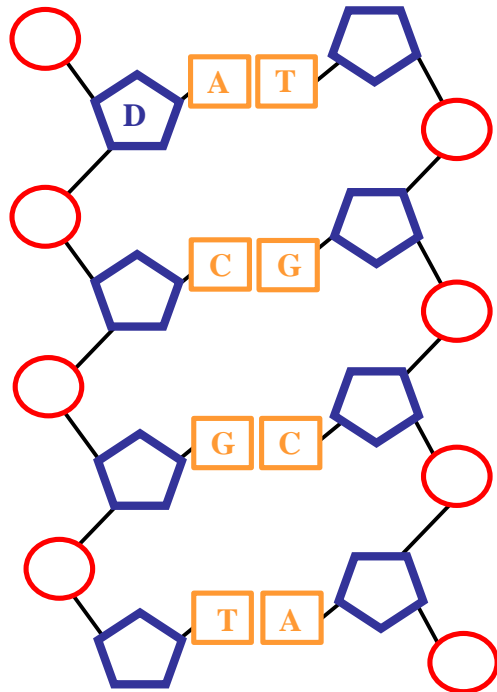

NUCLEIC ACID

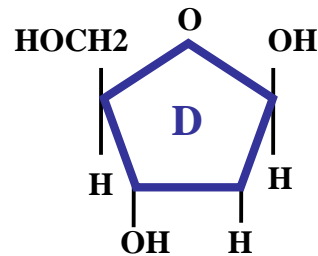

DEOXYRIBOSE

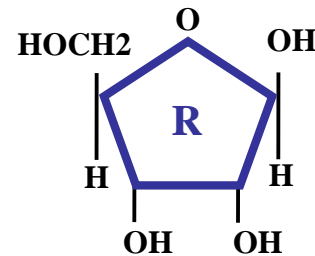

RIBOSE

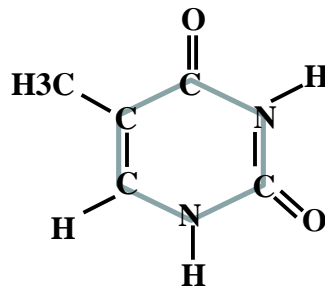

THYMINE

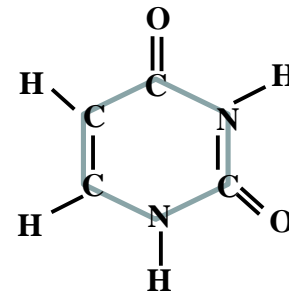

URACIL

RNA

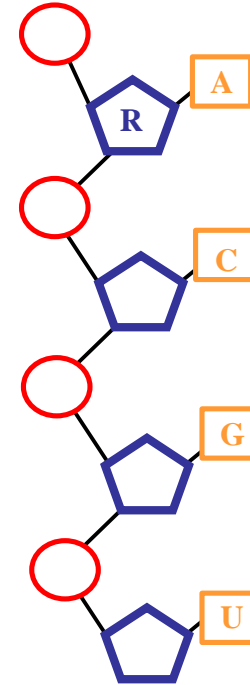

NUCLEIC ACID

NUCLEIC ACIDS

S

DNA

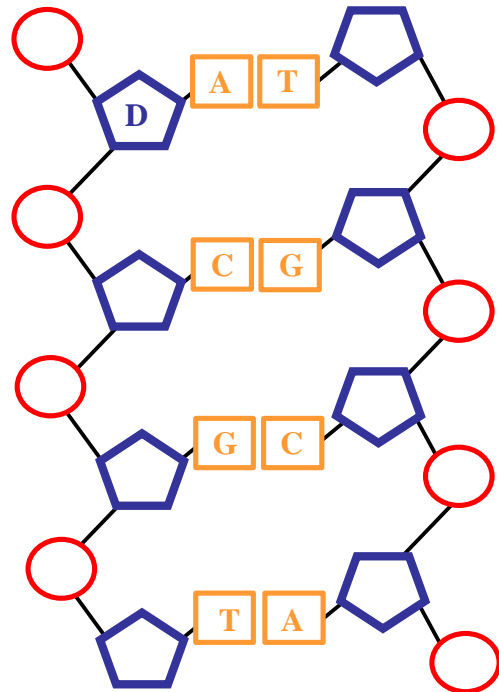

NUCLEIC ACID

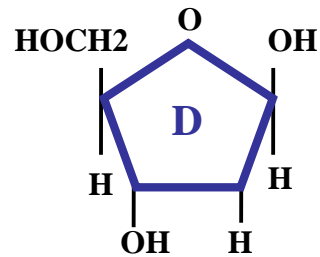

DEOXYRIBOSE

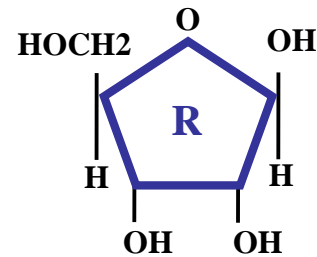

RIBOSE

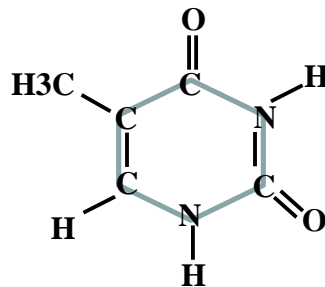

THYMINE

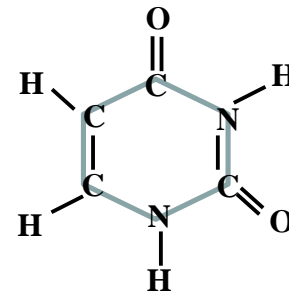

URACIL

RIBONUCLEIC ACID

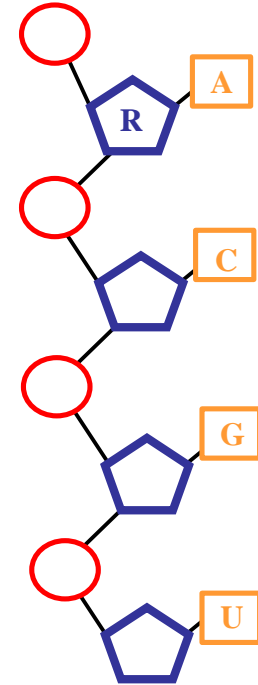

NUCLEIC ACID

NUCLEIC ACIDS

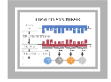

D

DNA

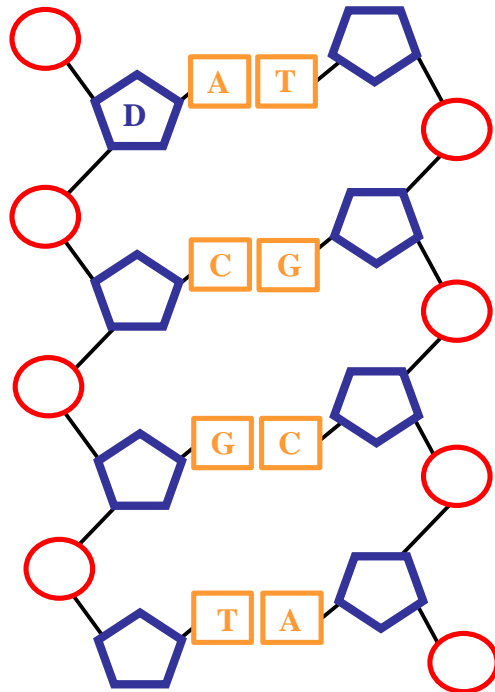

NUCLEIC ACID

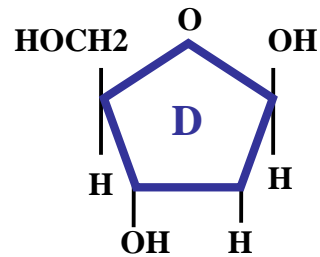

DEOXYRIBOSE

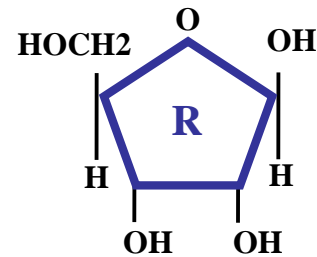

RIBOSE

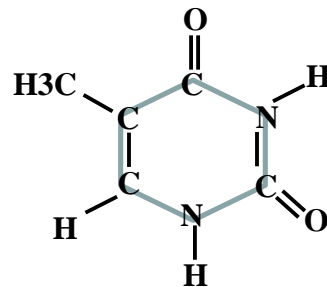

THYMINE

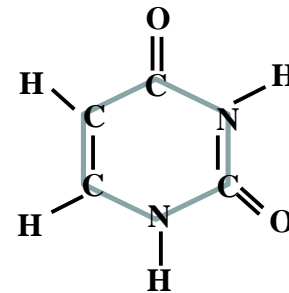

URACIL

RNA

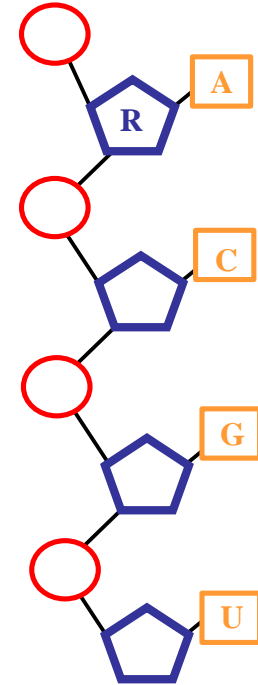

NUCLEIC ACID

PROTEIN SYNTHESIS

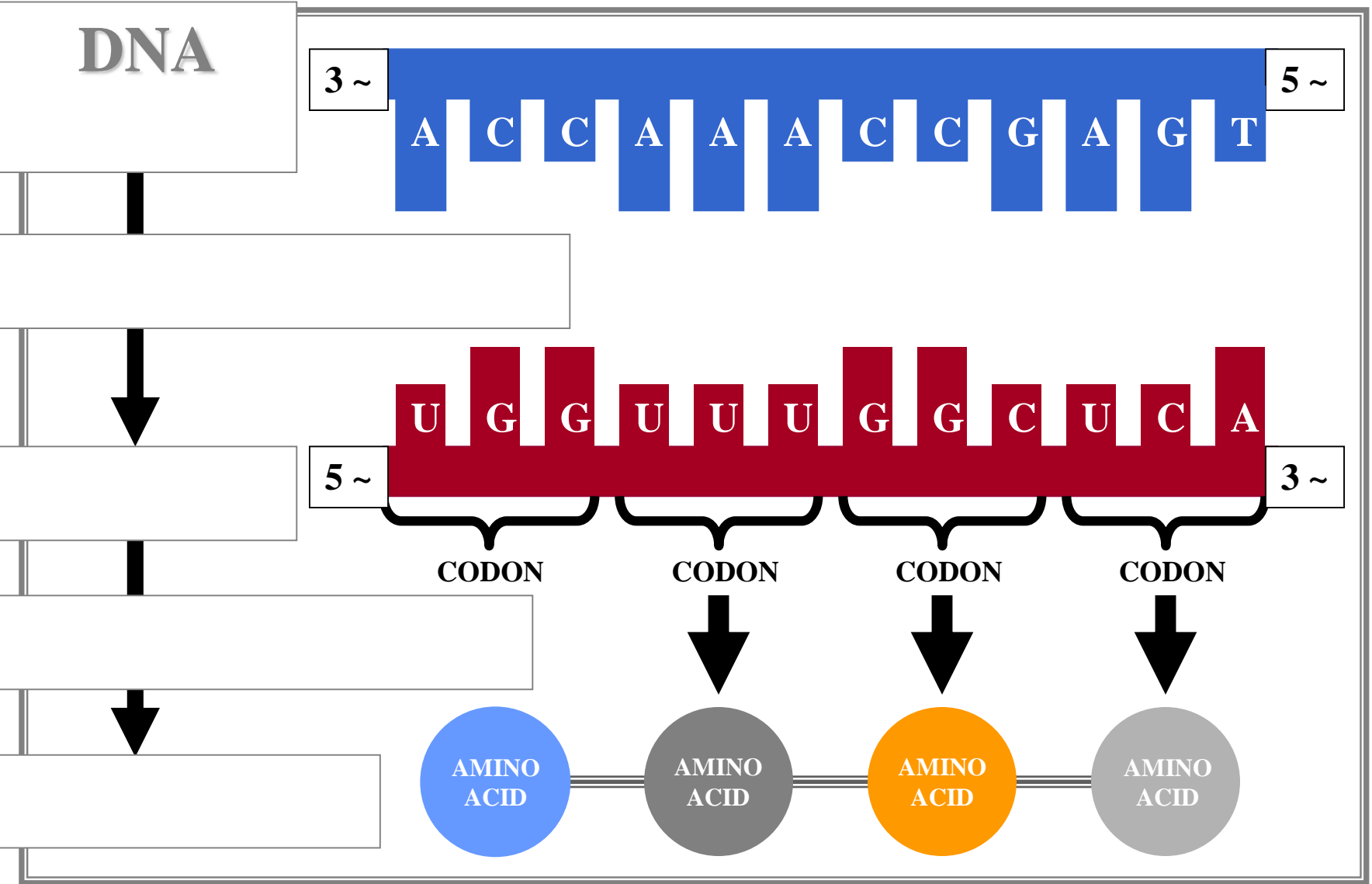

PROTEIN SYNTHESIS

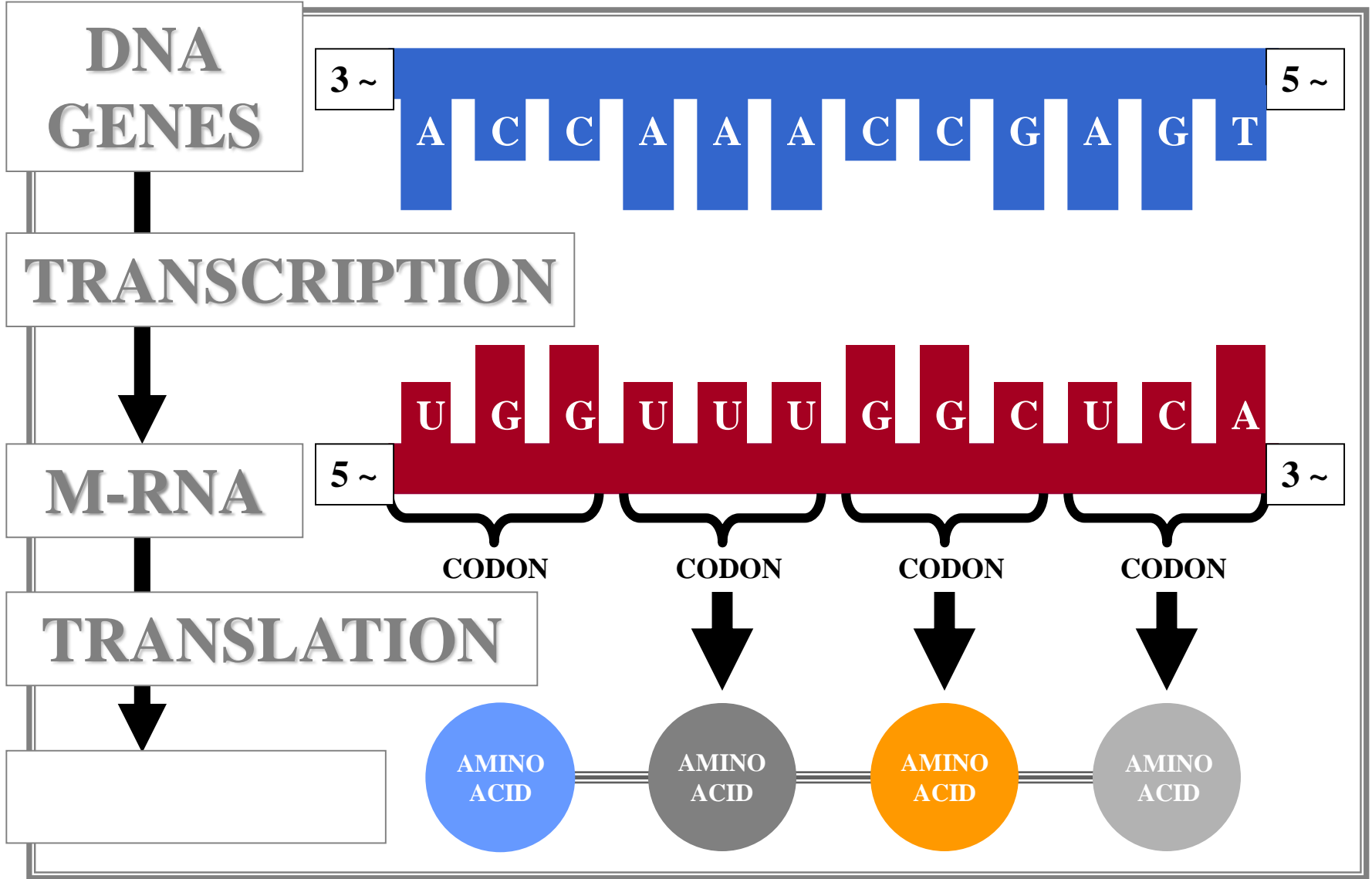

PROTEIN SYNTHESIS

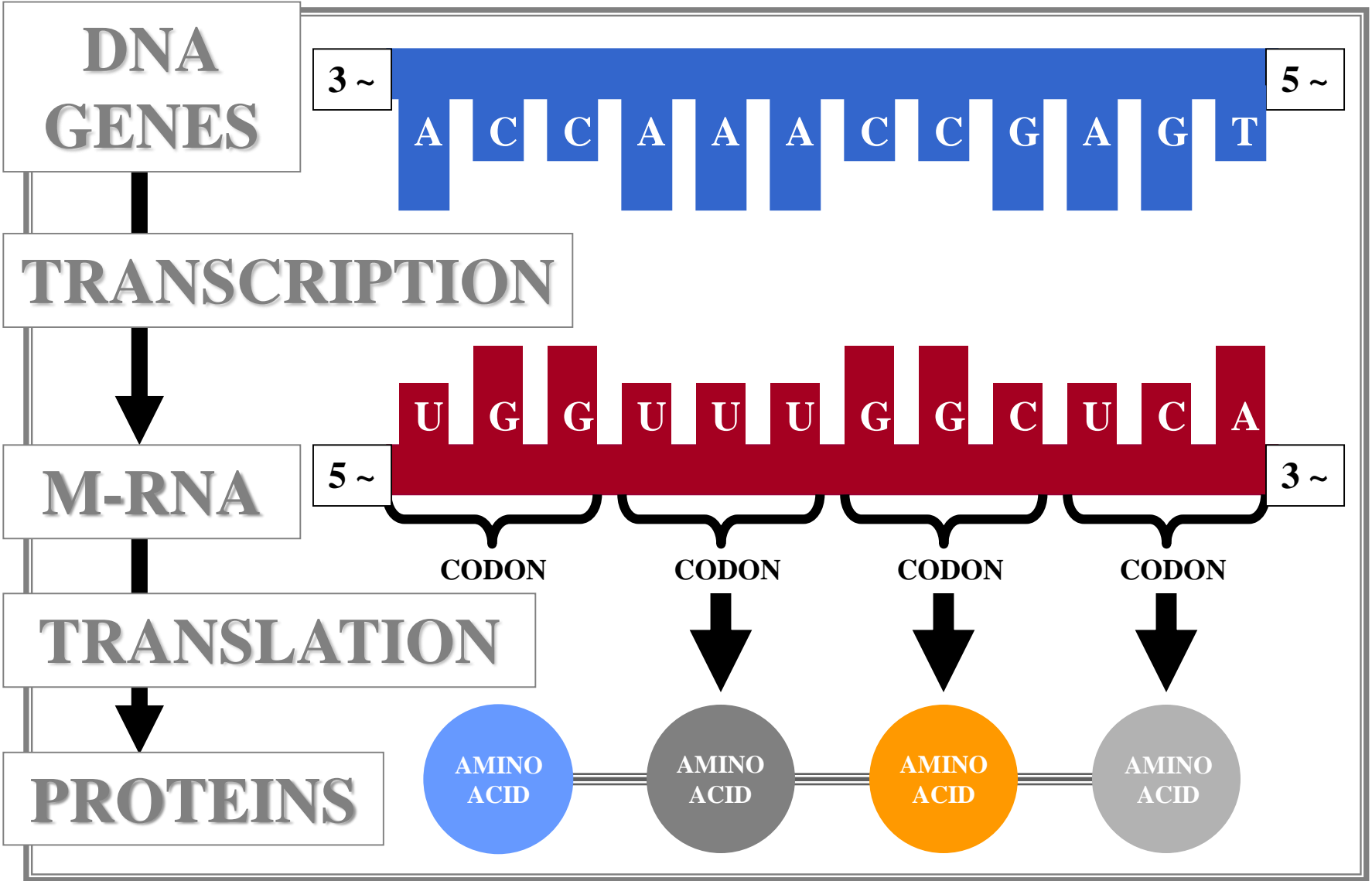

PROTEIN SYNTHESIS

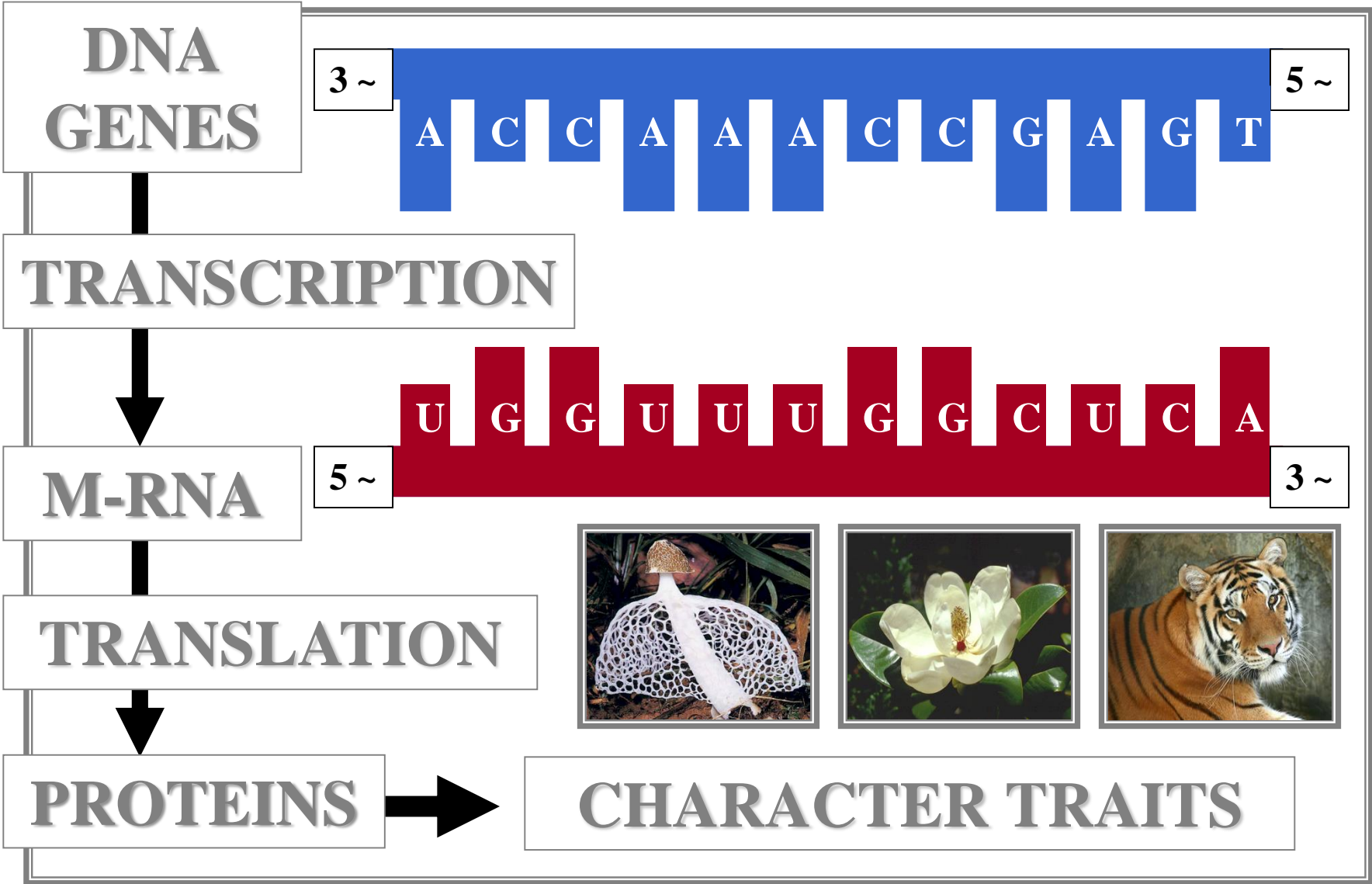

PROTEIN SYNTHESIS

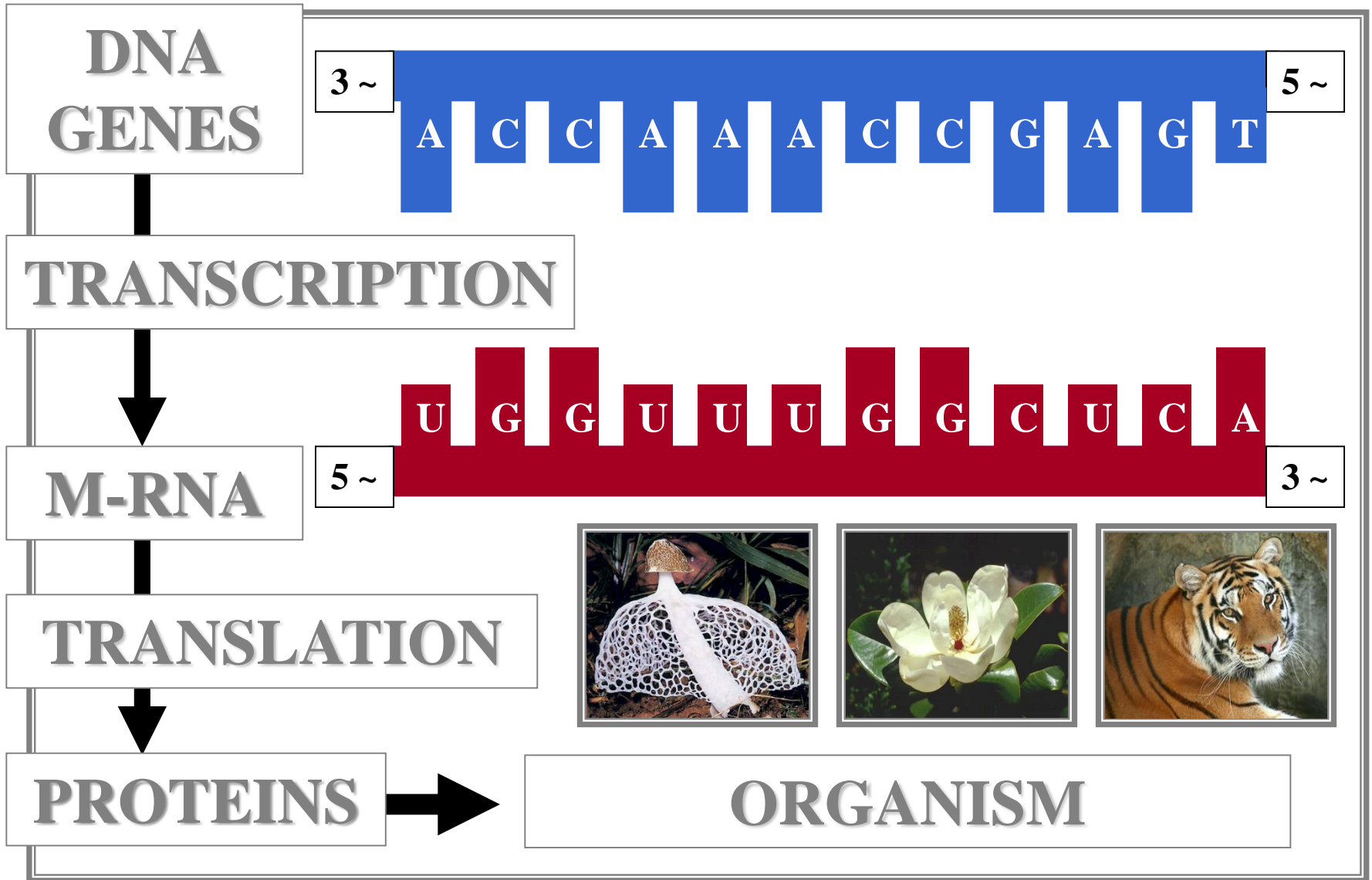



FUNGI DIVERSITY





ANIMAL DIVERSITY





PLANT DIVERSITY



NUCLEIC ACIDS



DNA

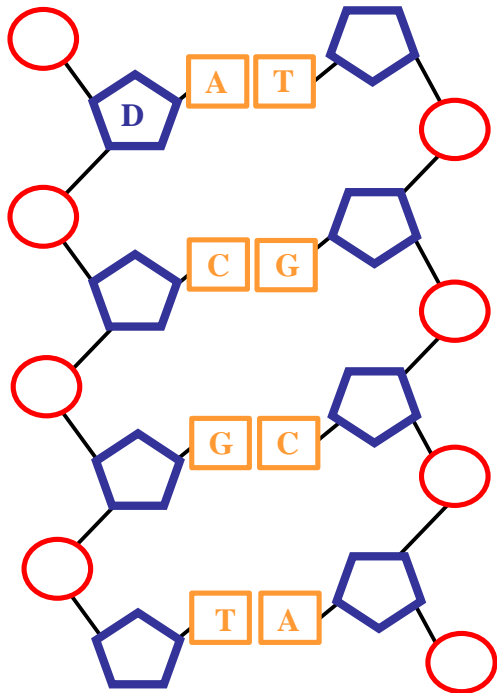

DNA
UNDERGOES
MUTATIONAL
CHANGES

MUTATION

MUTATION

MUTATION



DNA STRUCTURAL CHANGE

MUTATION

DNA

DEOXYRIBONUCLEIC ACID

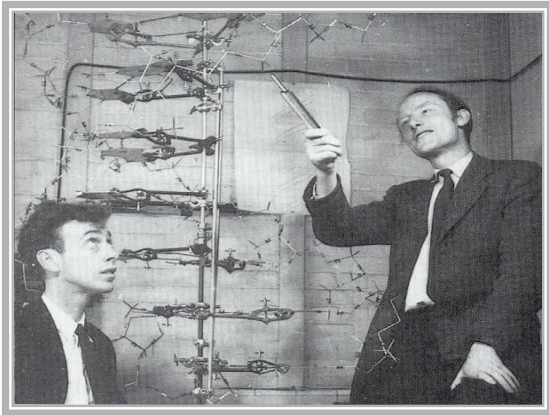

JAMES WATSON
&
FRANCIS CRICK

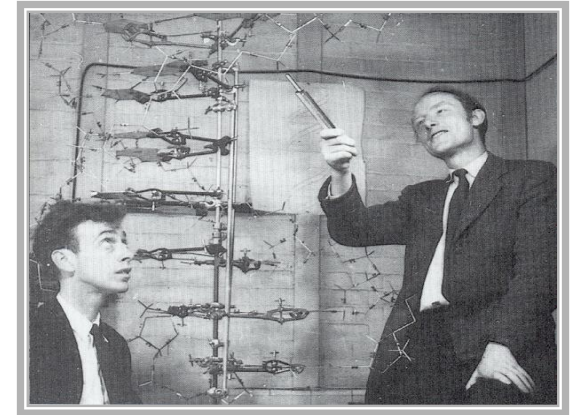
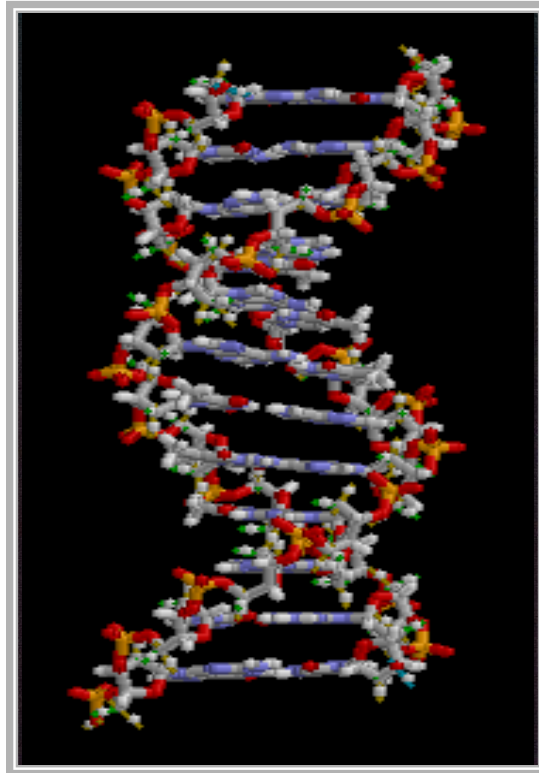

JAMES WATSON
&
FRANCIS CRICK

?

DNA DEOXYRIBONUCLEIC ACID

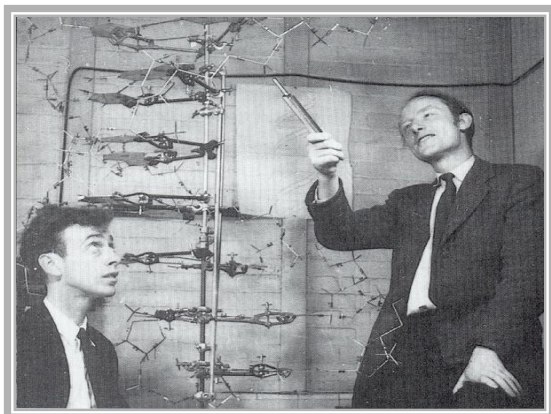

JAMES WATSON
&
FRANCIS CRICK

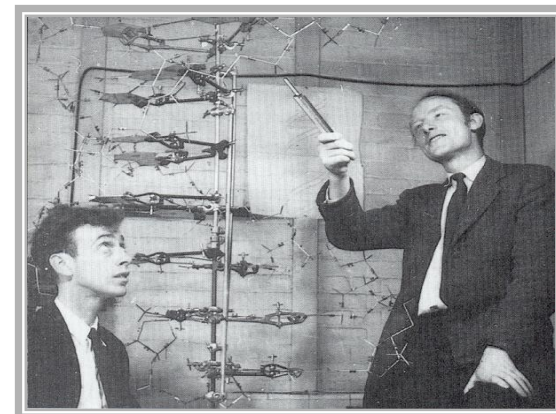
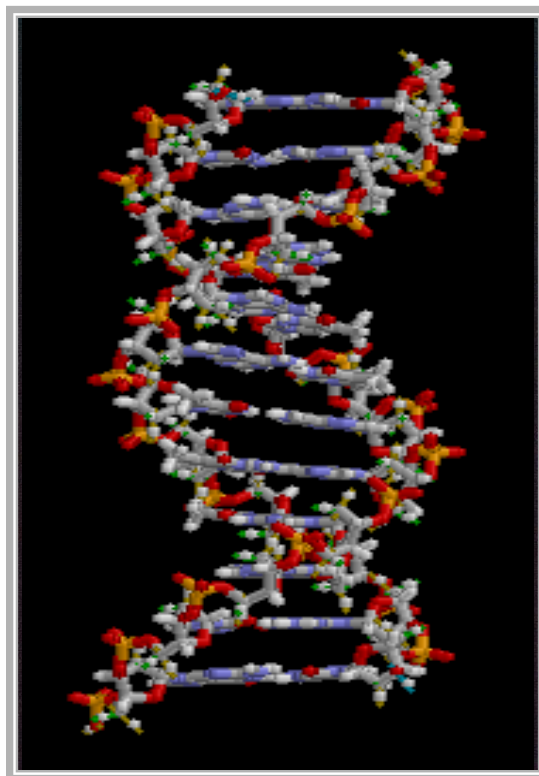

JAMES WATSON
&
FRANCIS CRICK

DOUBLE HELIX MODEL

DNA

DEOXYRIBONUCLEIC ACID

**DOUBLE
HELIX
MODEL**

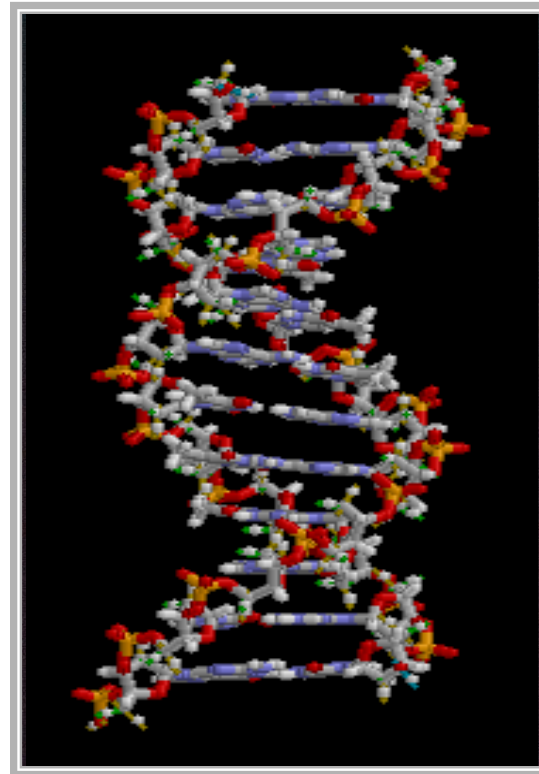

**DOUBLE
HELIX
MODEL**

POLYMER

DNA

DEOXYRIBONUCLEIC ACID

DOUBLE
HELIX
MODEL

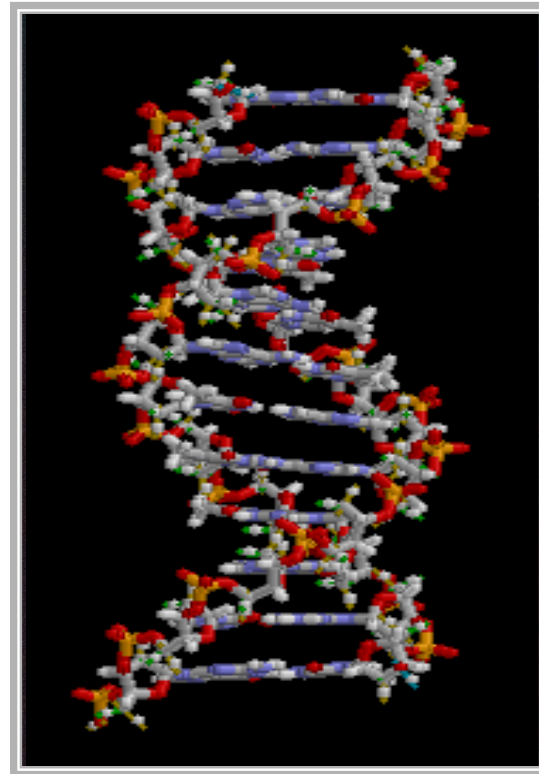

DOUBLE
HELIX
MODEL

MONOMERS

DNA

DEOXYRIBONUCLEIC ACID

DOUBLE
HELIX
MODEL

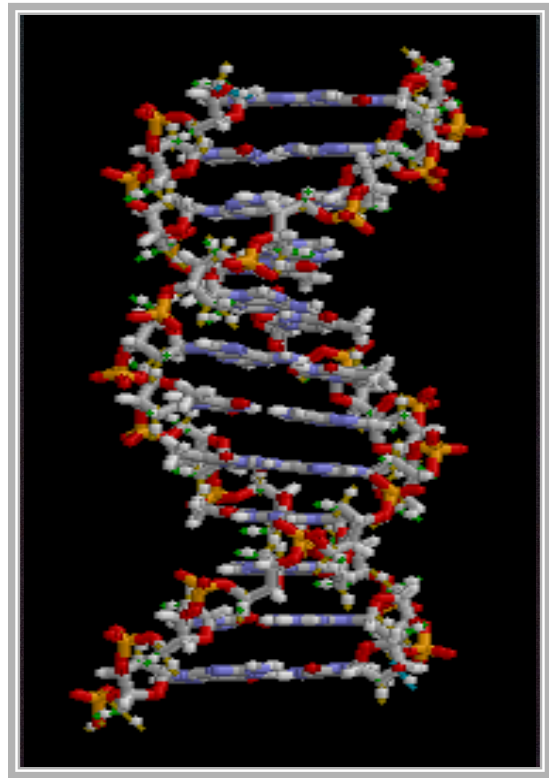

DOUBLE
HELIX
MODEL

NUCLEOTIDES

DNA NUCLEOTIDE MONOMERS

G

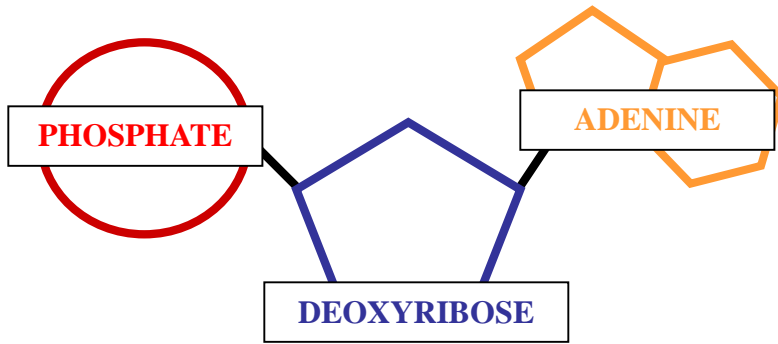

ADENINE

DNA NUCLEOTIDE MONOMERS

T

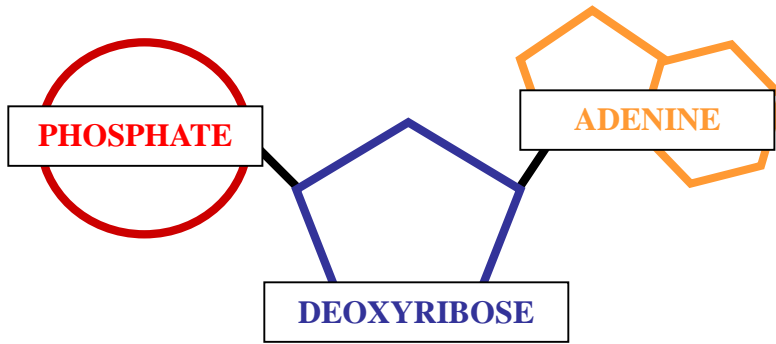

ADENINE

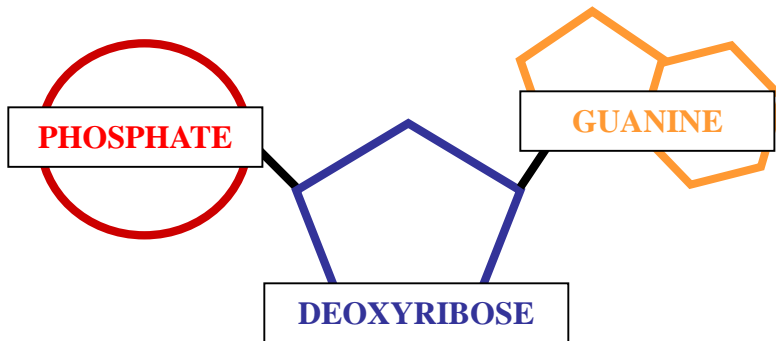

GUANINE

DNA NUCLEOTIDE MONOMERS

C

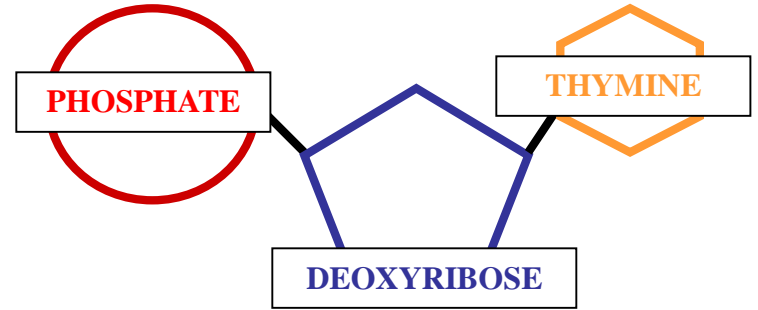
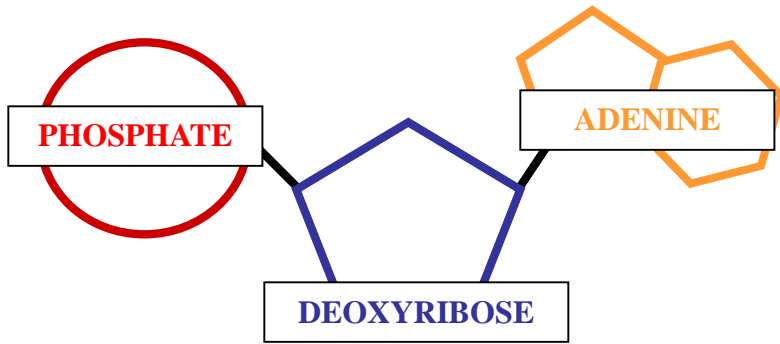

ADENINE

THYMINE

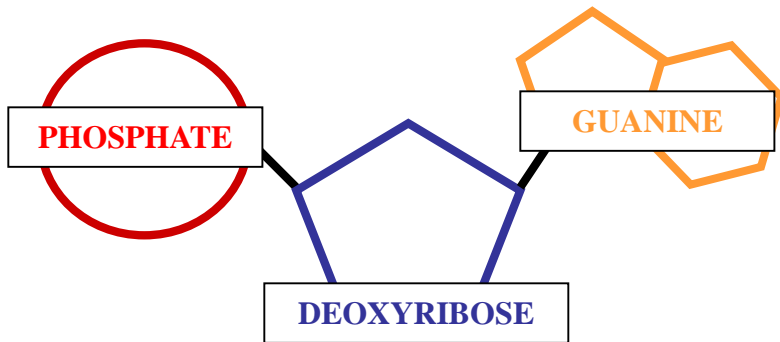

GUANINE

DNA NUCLEOTIDE MONOMERS

A-T

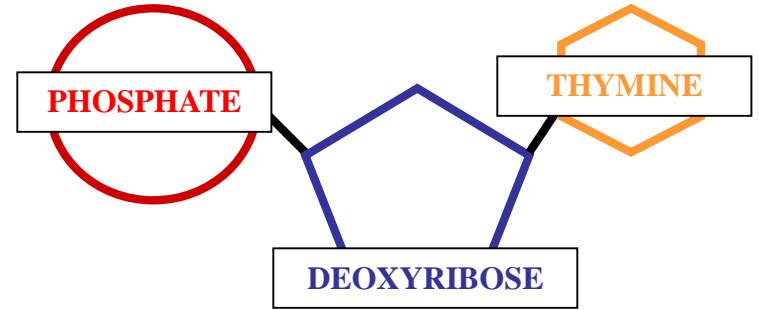
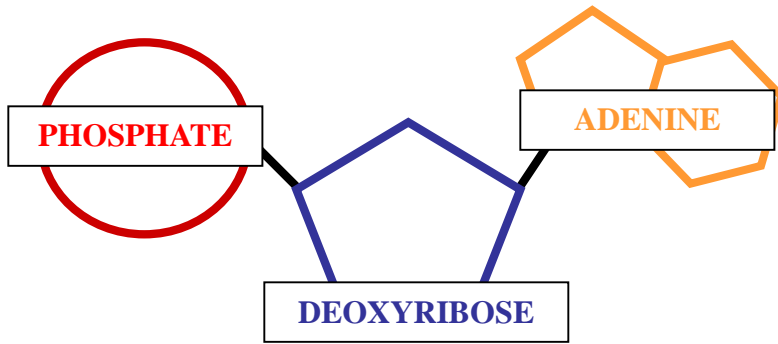

ADENINE

THYMINE

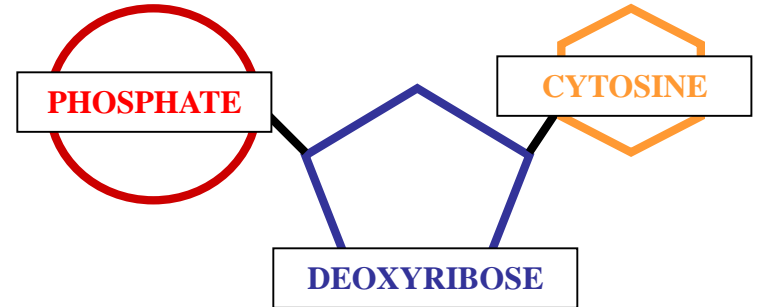
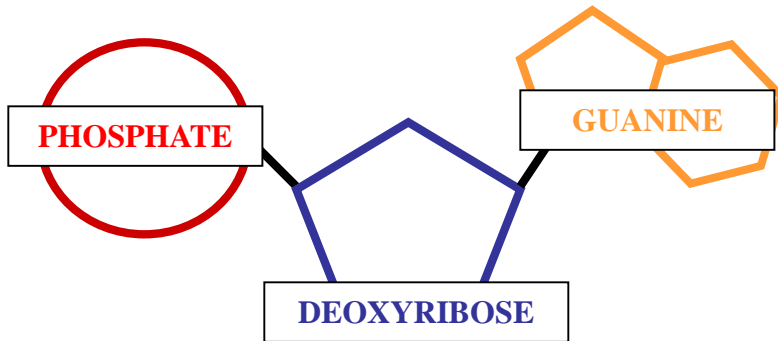

GUANINE

CYTOSINE

DNA DOUBLE HELIX MODEL / NUCLEOTIDE BASE PAIRS

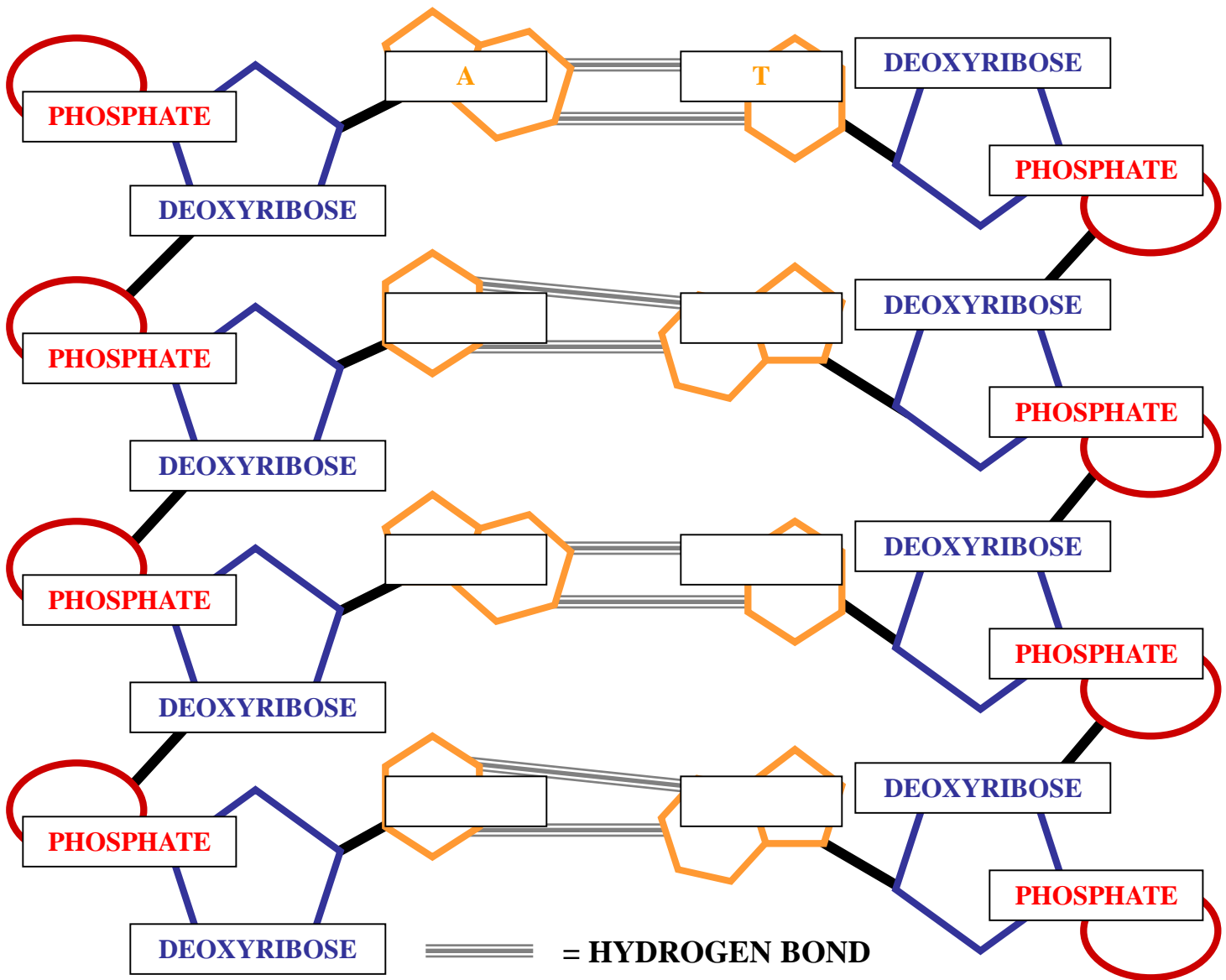
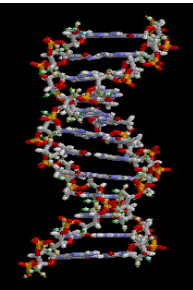

DNA DOUBLE HELIX MODEL / NUCLEOTIDE BASE PAIRS

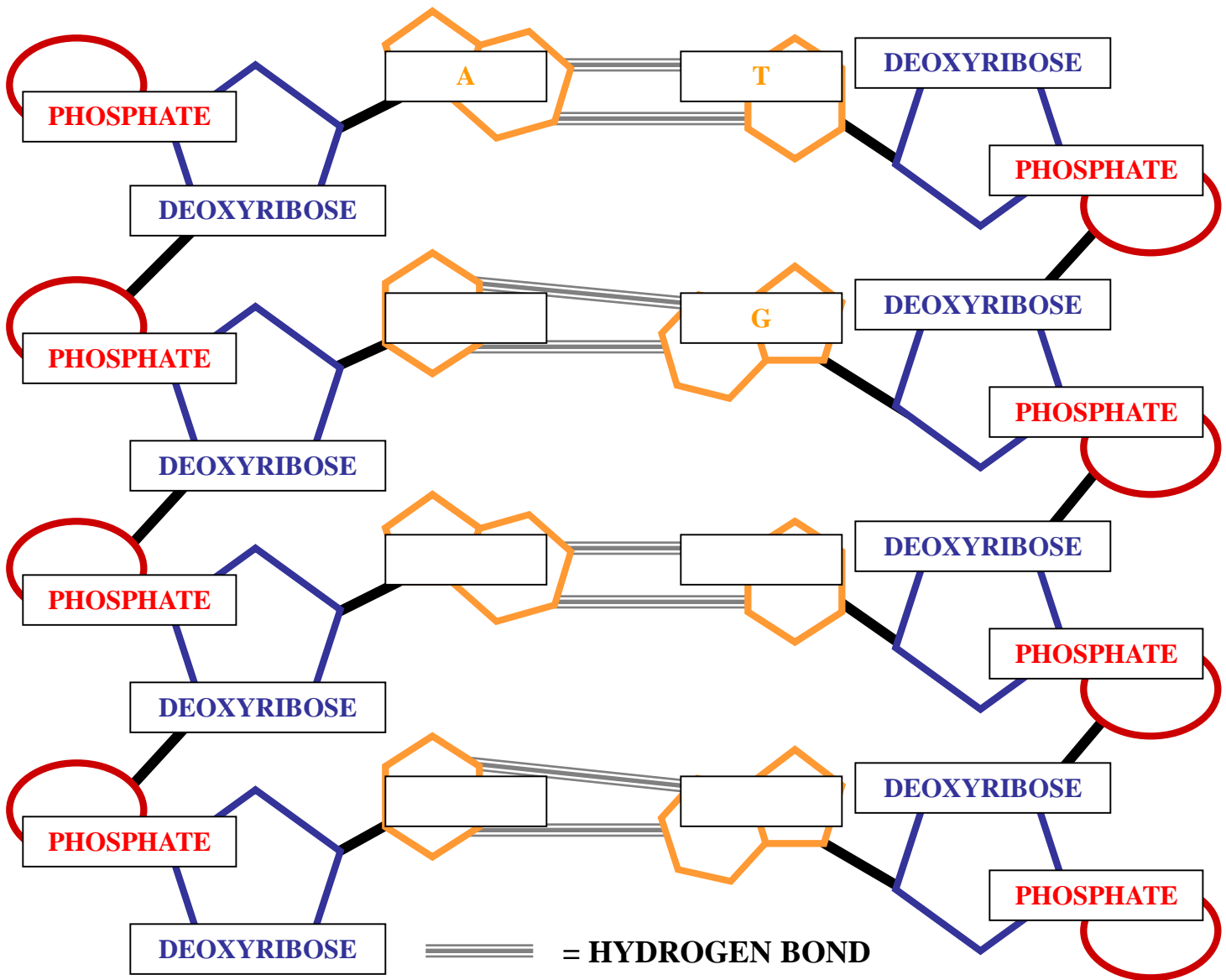

DNA DOUBLE HELIX MODEL / NUCLEOTIDE BASE PAIRS

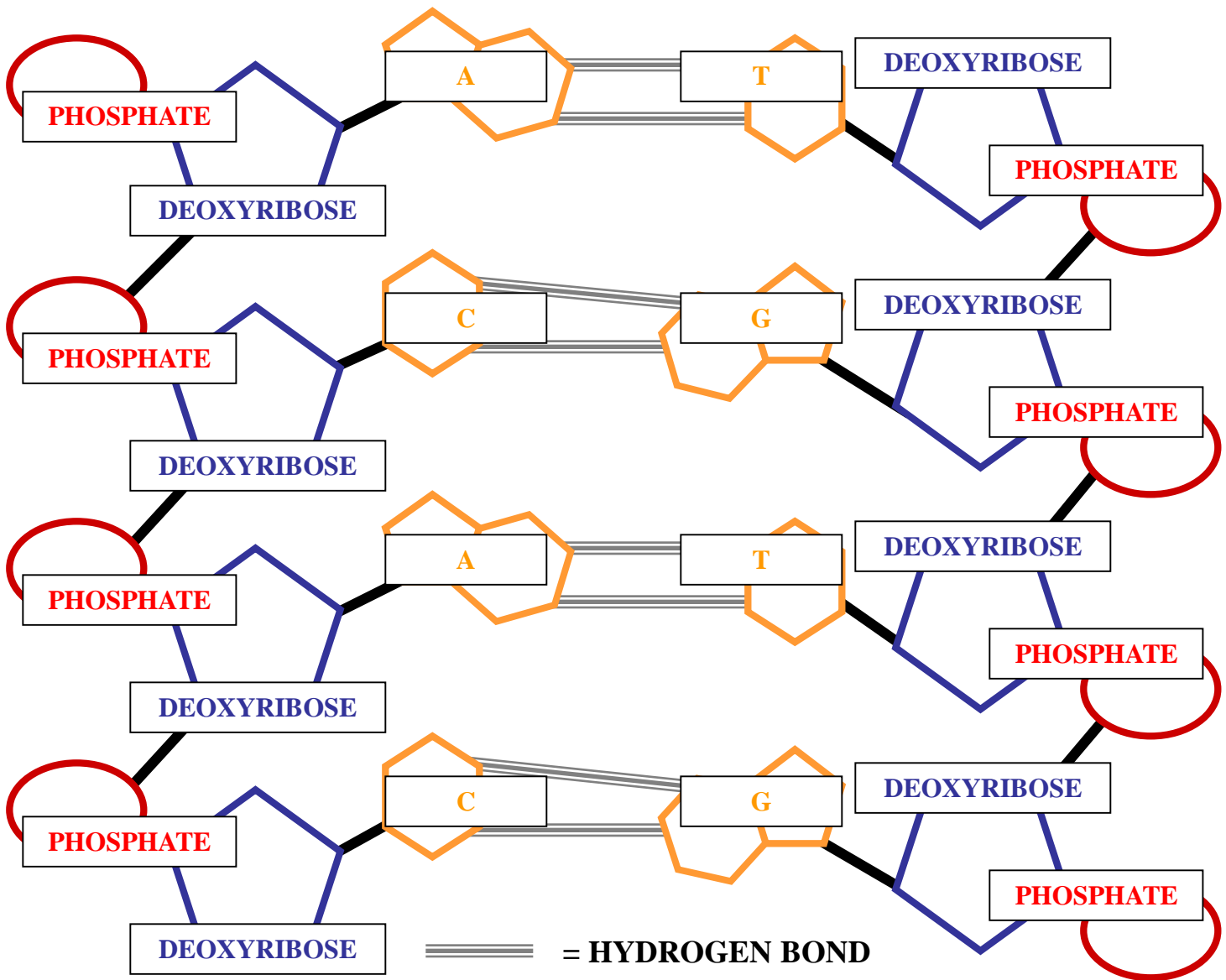
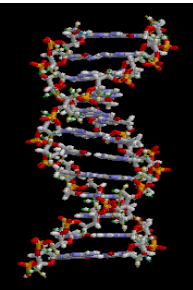

DNA

DEOXYRIBONUCLEIC ACID

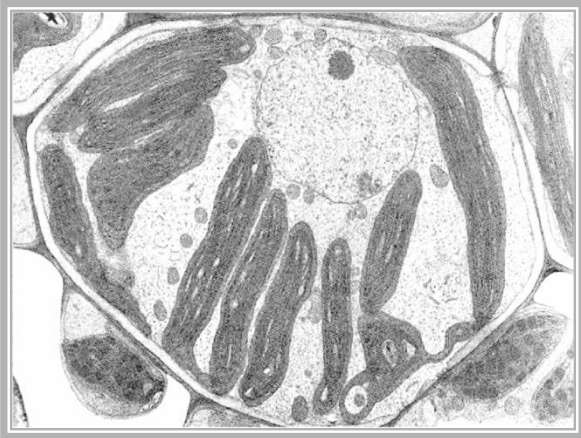

PLANT CELL

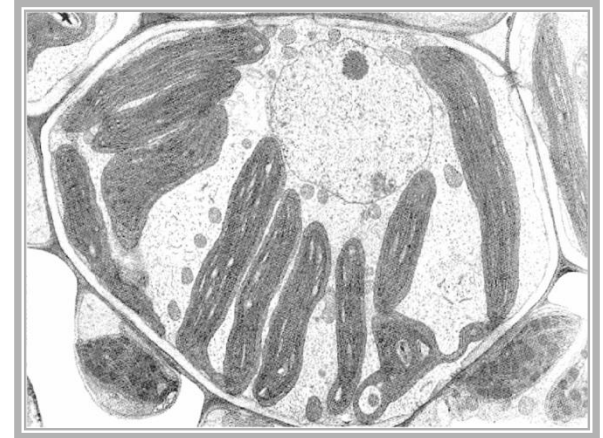
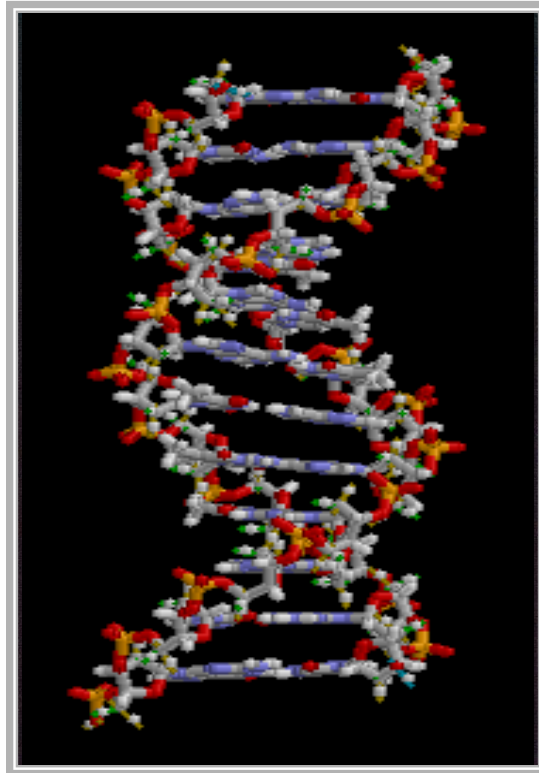

PLANT CELL

CELL CYCLE

DNA

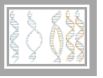

DEOXYRIBONUCLEIC ACID



PLANT CELL

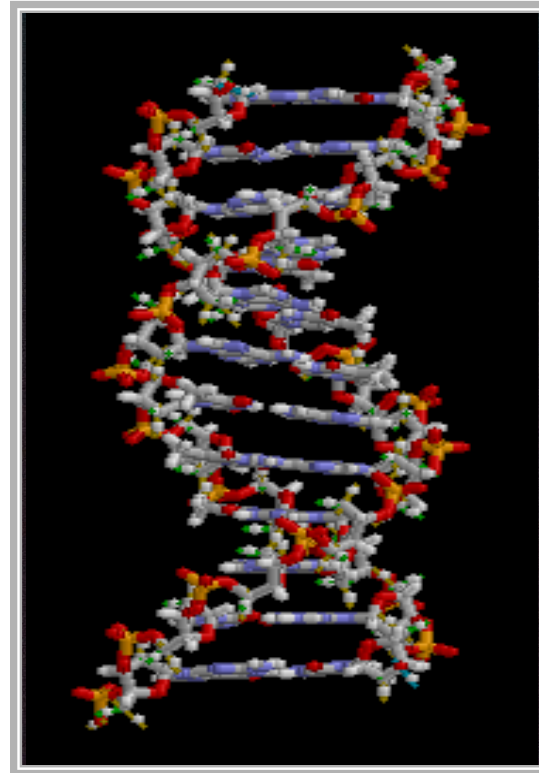

PLANT CELL

REPLICATION

DNA REPLICATION

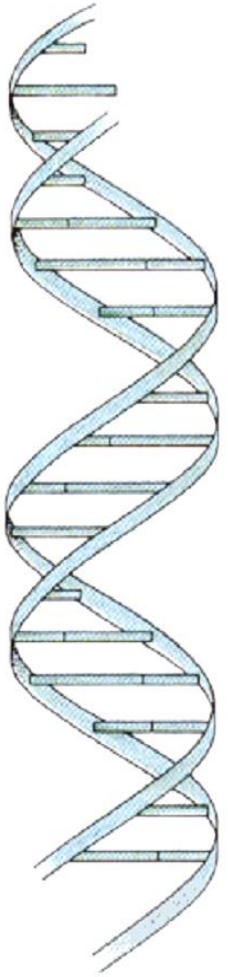
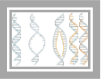

**DNA
CHROMOSOME**

DNA REPLICATION

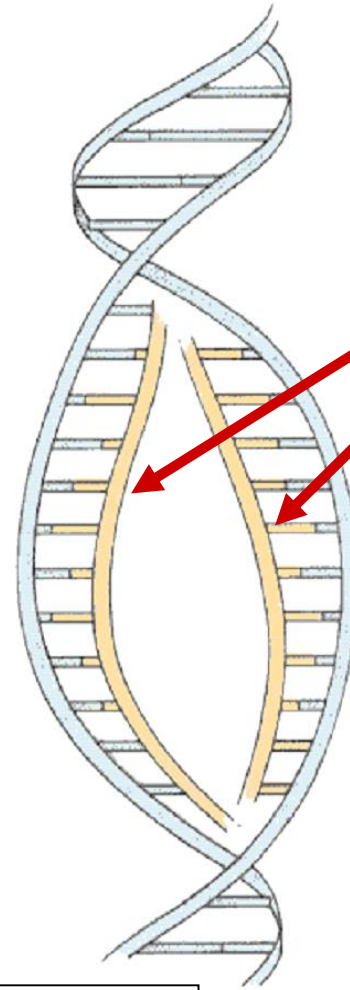
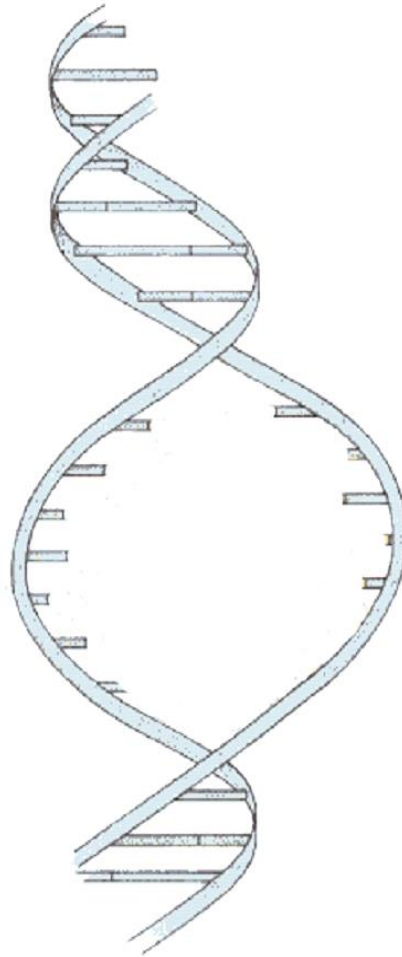
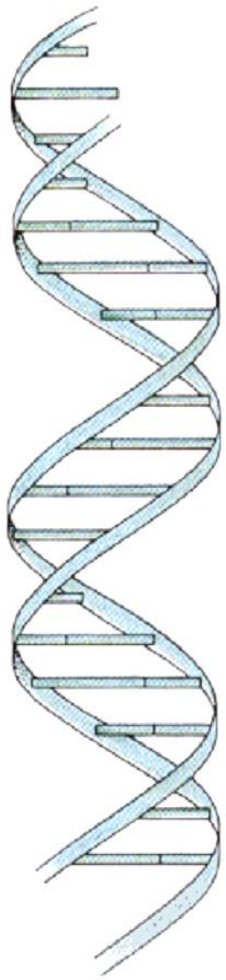
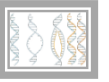

**NEWLY REPLICATED
DNA STRANDS**

**DNA
CHROMOSOME**

REPLICATION



DNA REPLICATION

?

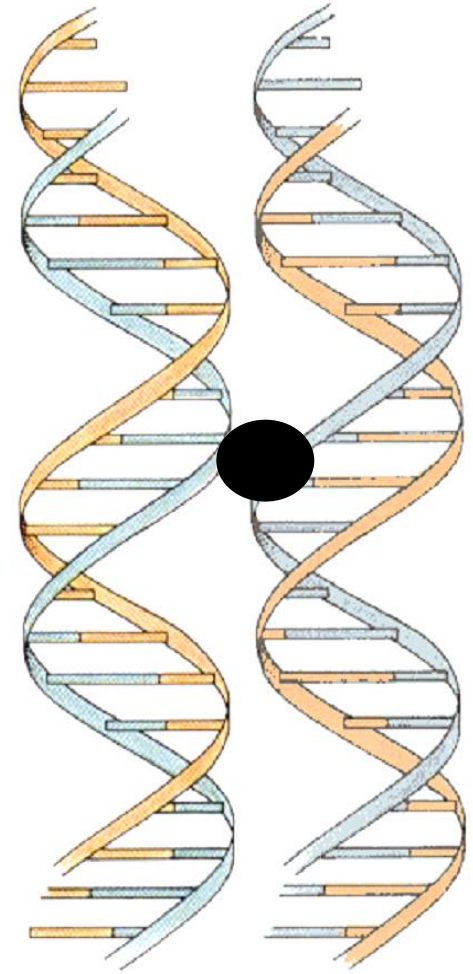
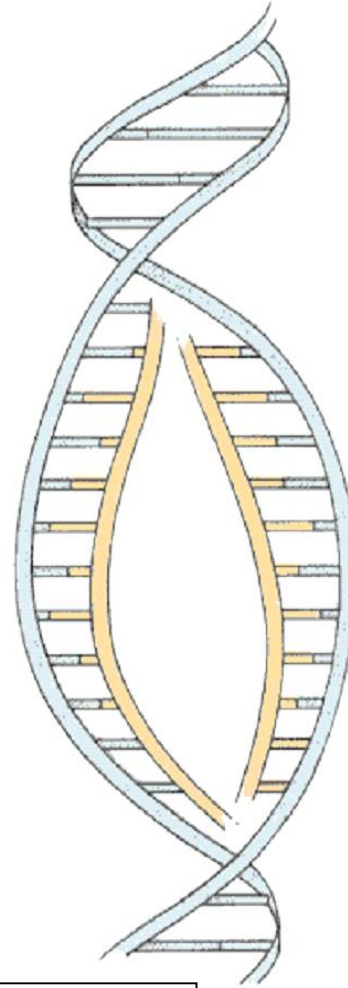
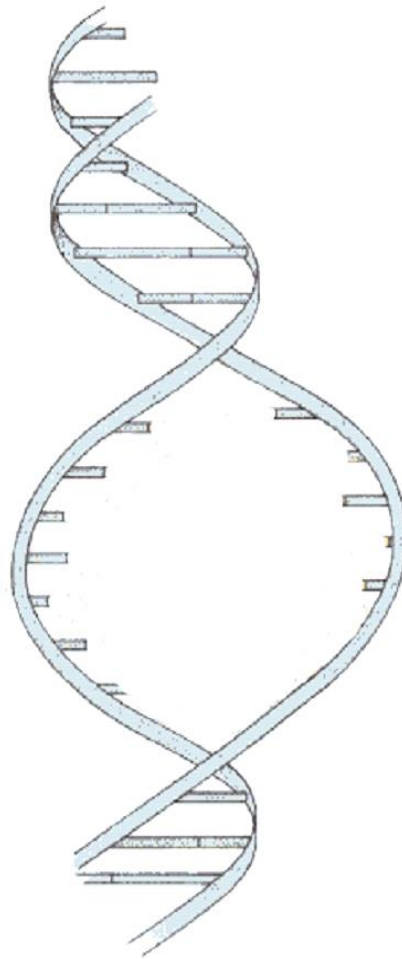
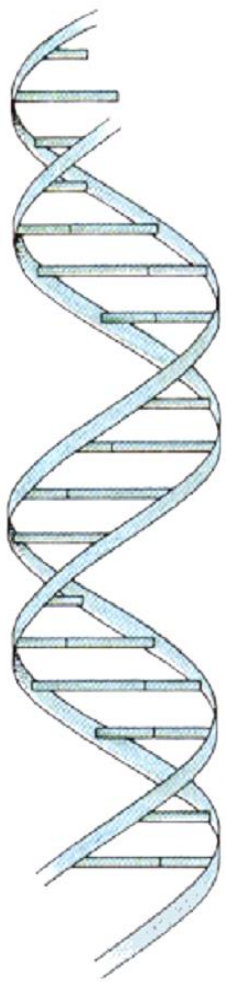

DNA
CHROMOSOME

REPLICATION

REPLICATED DNA
CHROMOSOME

DNA REPLICATION

C

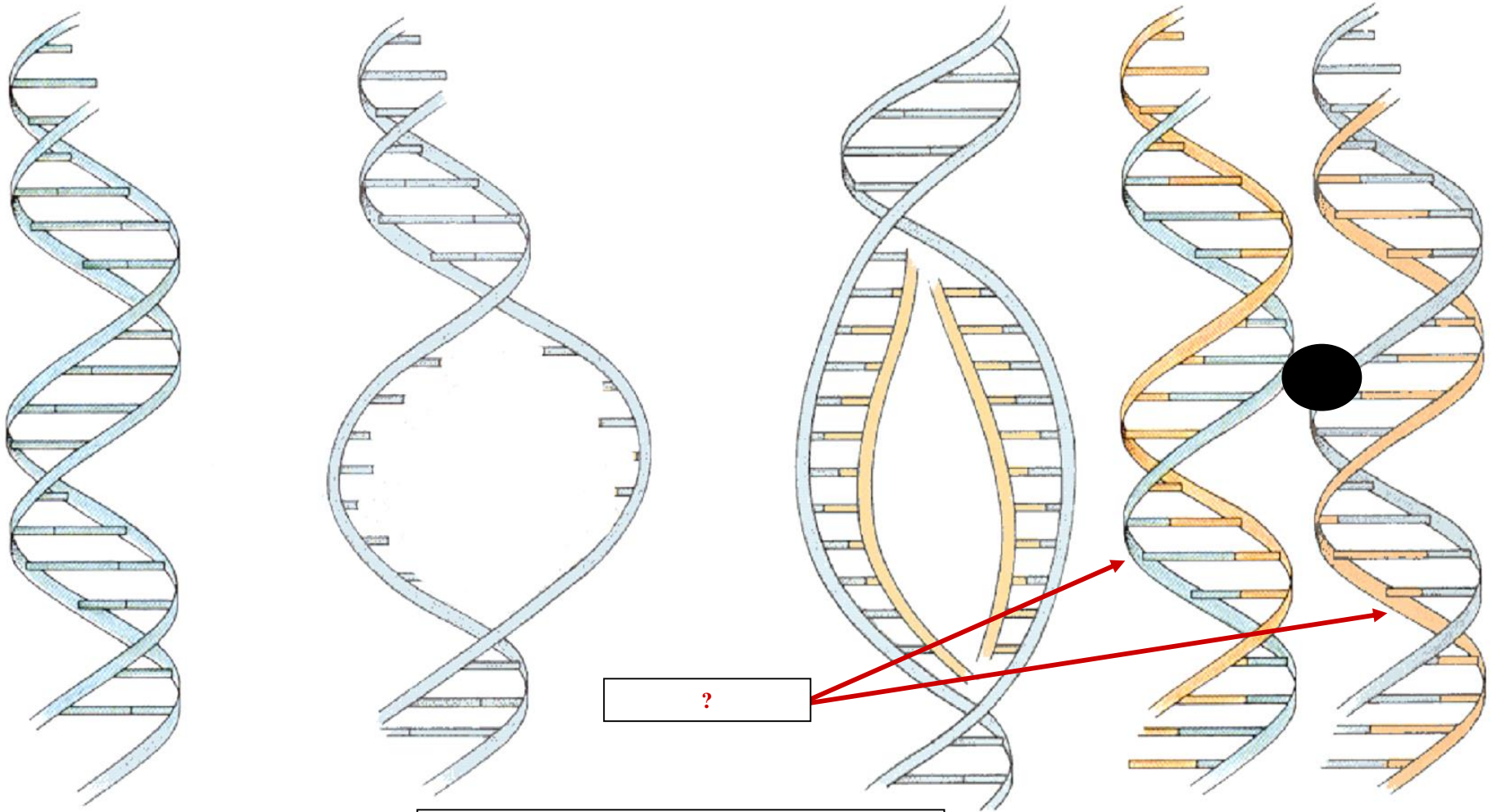

DNA
CHROMOSOME

REPLICATION

REPLICATED DNA
CHROMOSOME

DNA REPLICATION

?

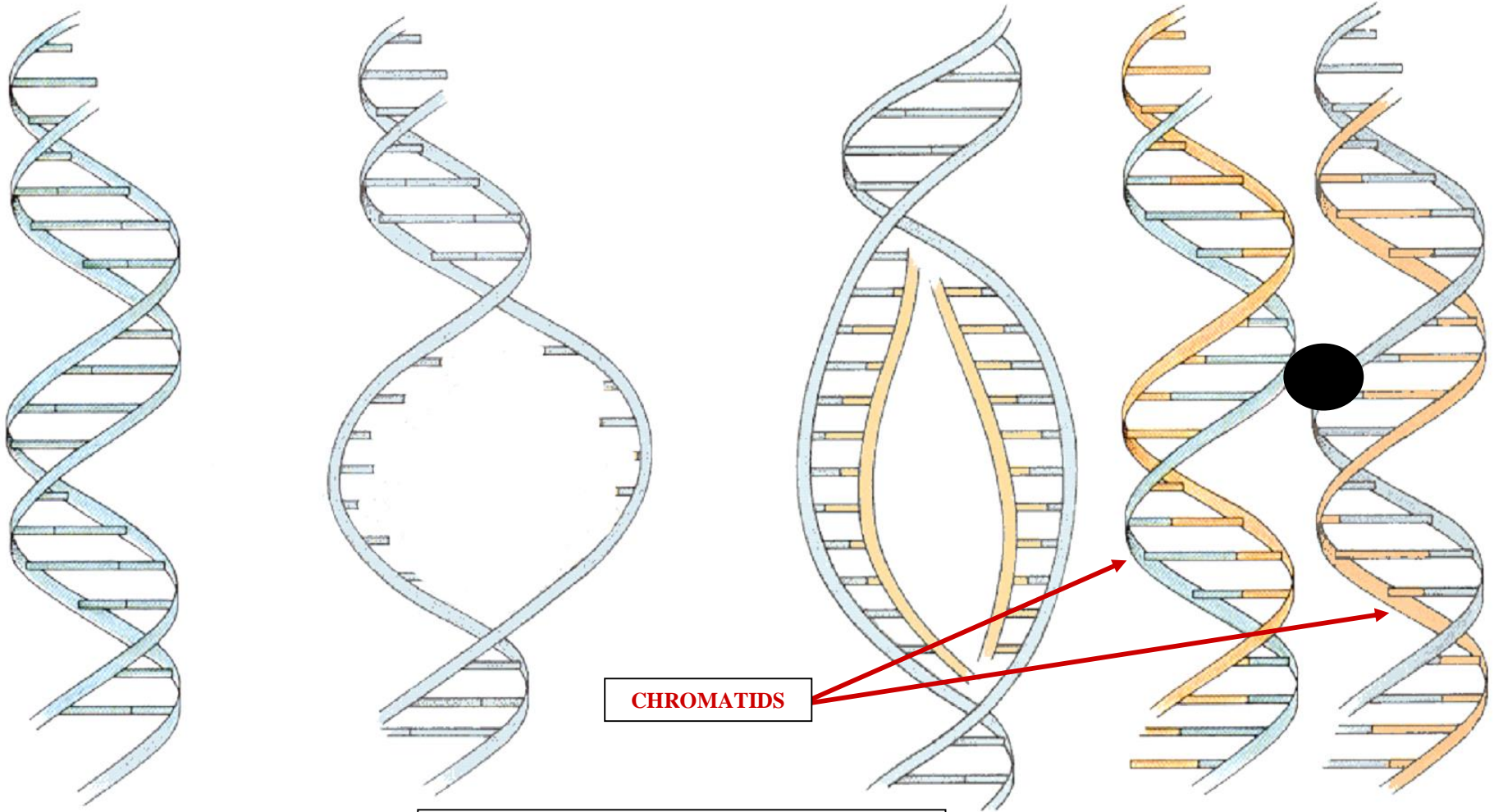

DNA
CHROMOSOME

REPLICATION

REPLICATED DNA
CHROMOSOME

DNA REPLICATION

C

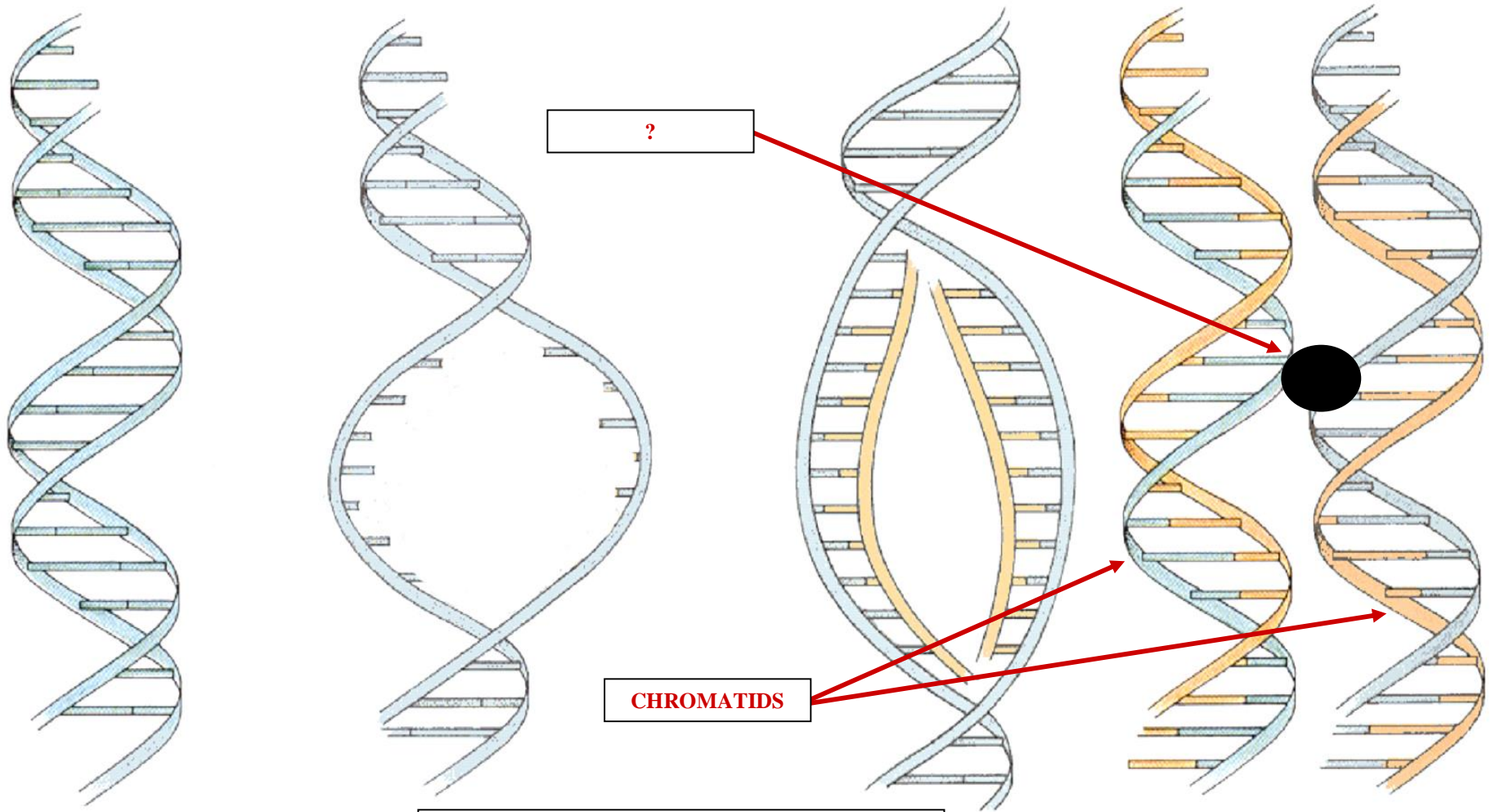

DNA
CHROMOSOME

REPLICATION

REPLICATED DNA
CHROMOSOME

DNA REPLICATION

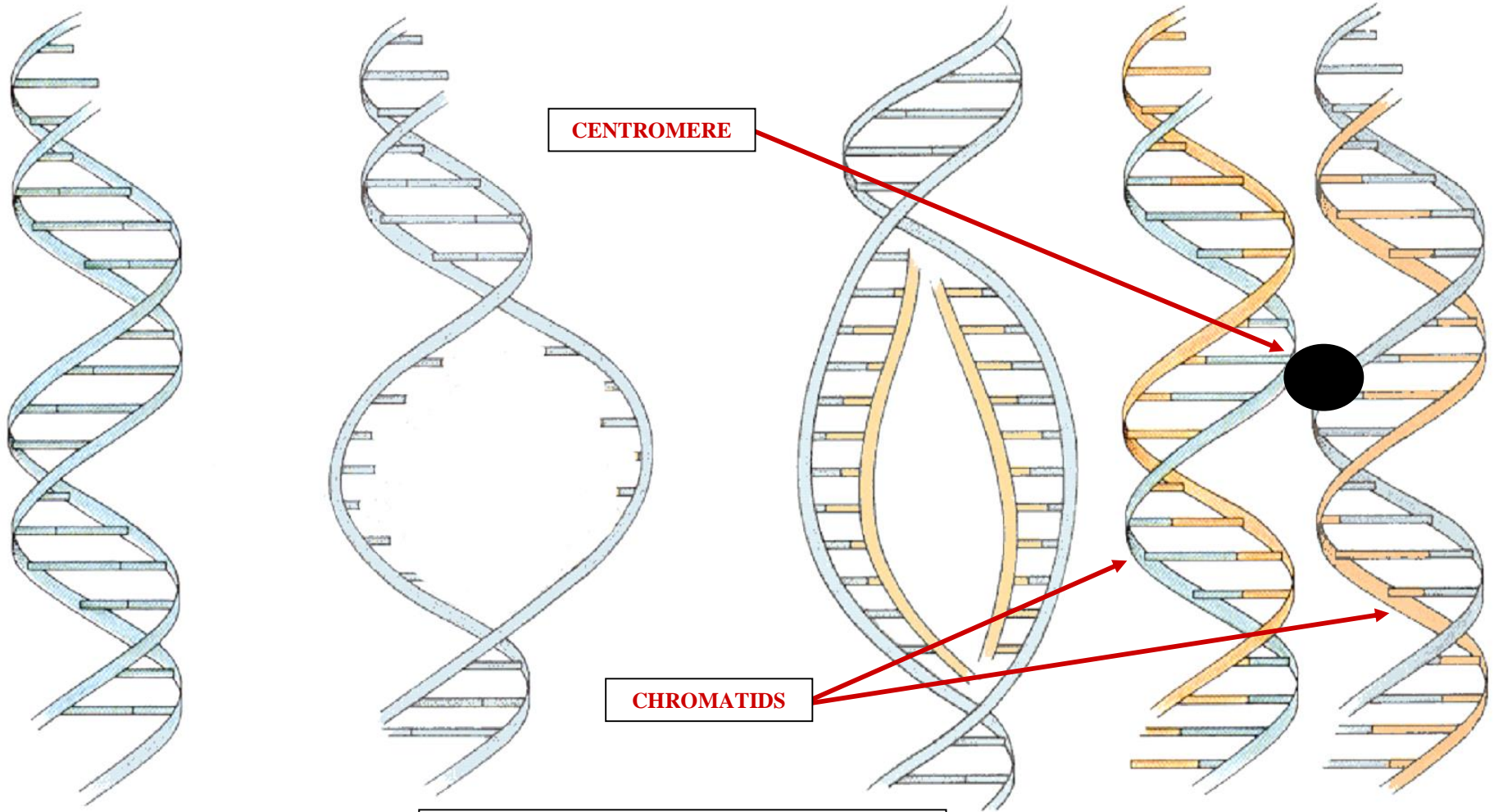

CENTROMERE

CHROMATIDS

DNA
CHROMOSOME

REPLICATION

REPLICATED DNA
CHROMOSOME

DURING REPLICATION

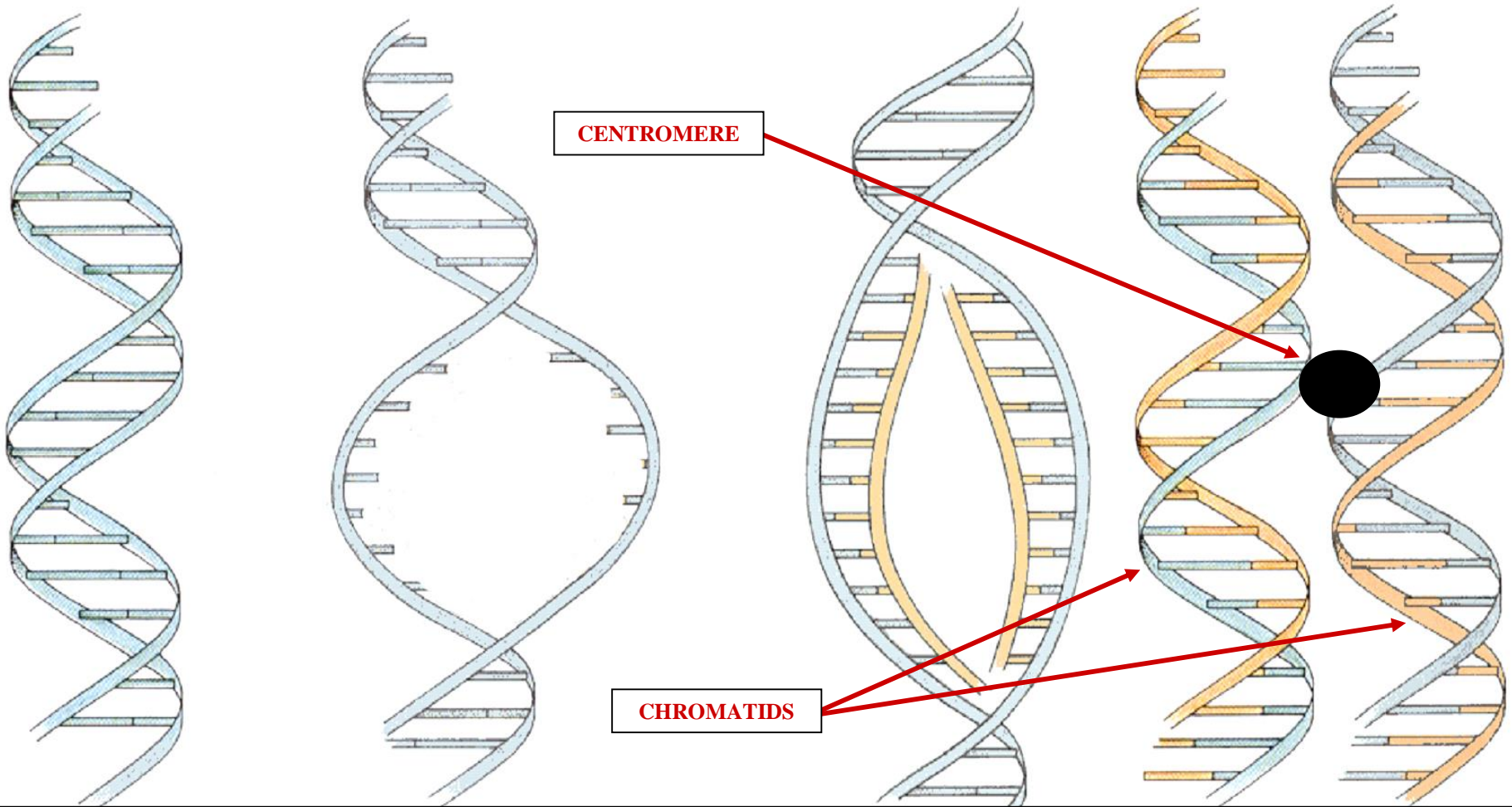

DNA UNDERGOES MUTATIONS

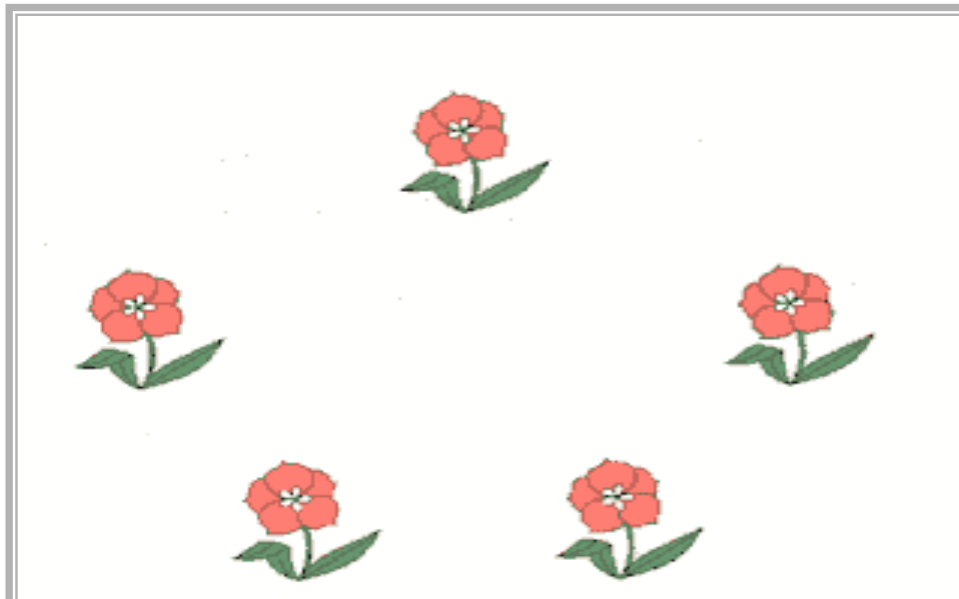

PLANT POPULATION

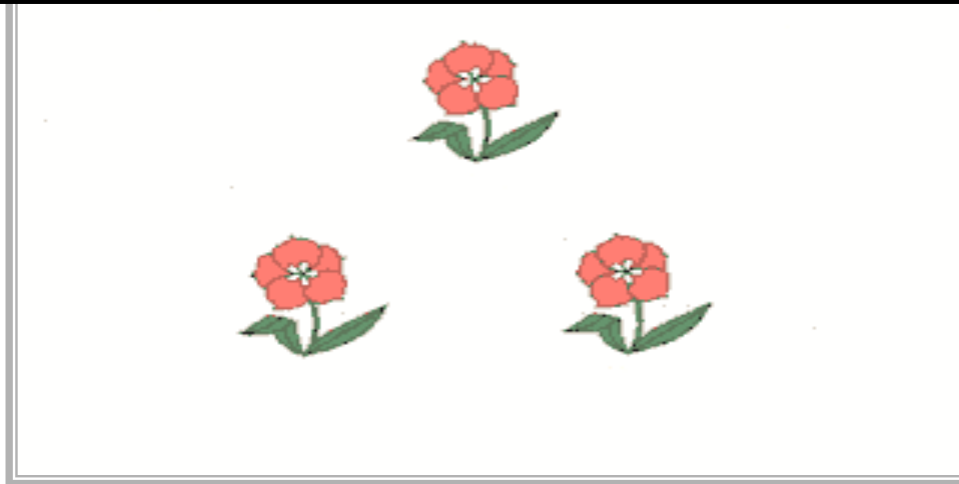

RED FLOWERED PLANTS

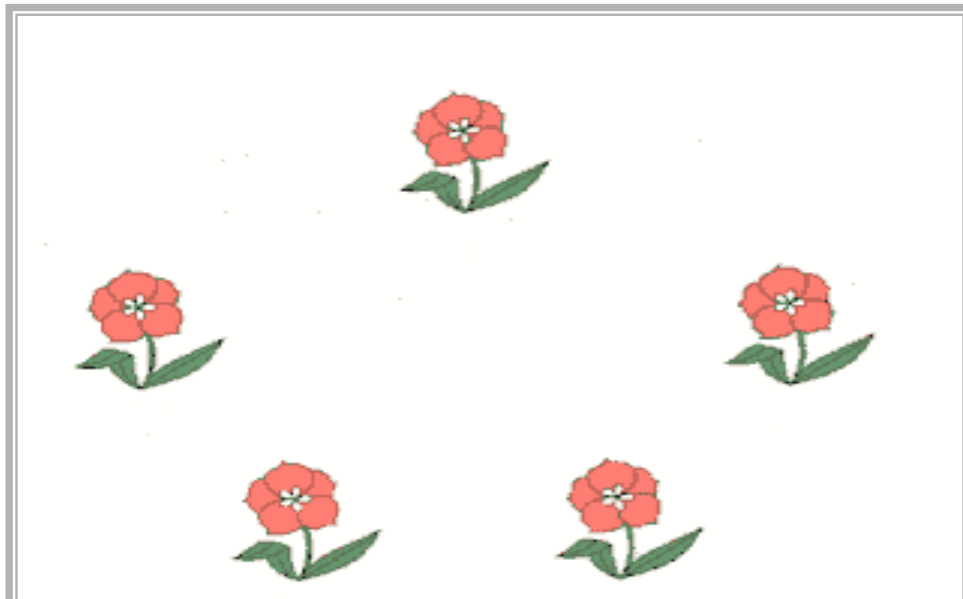

UNDERGOES MUTATION

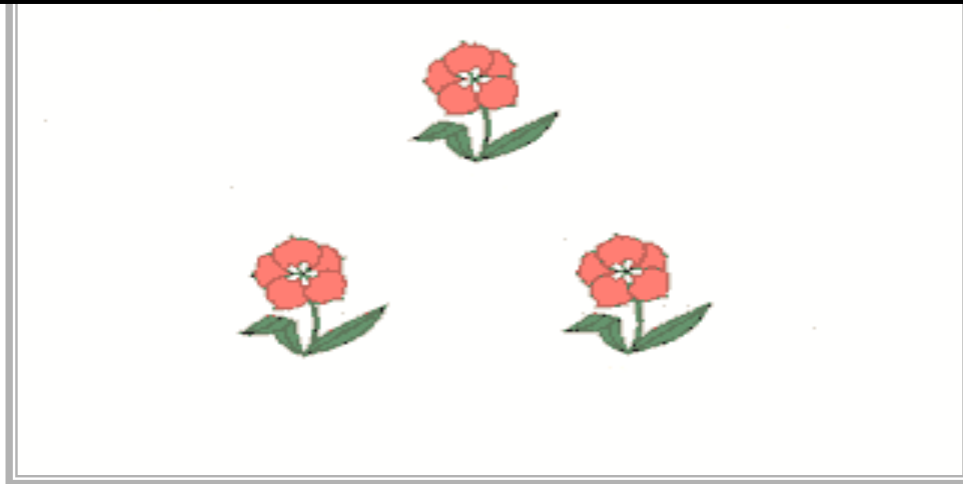

RED FLOWERED PLANTS

DNA DOUBLE HELIX MODEL

DNA REPLICATION

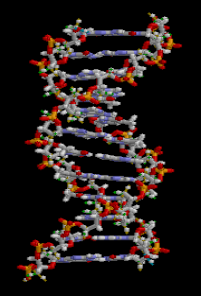

G

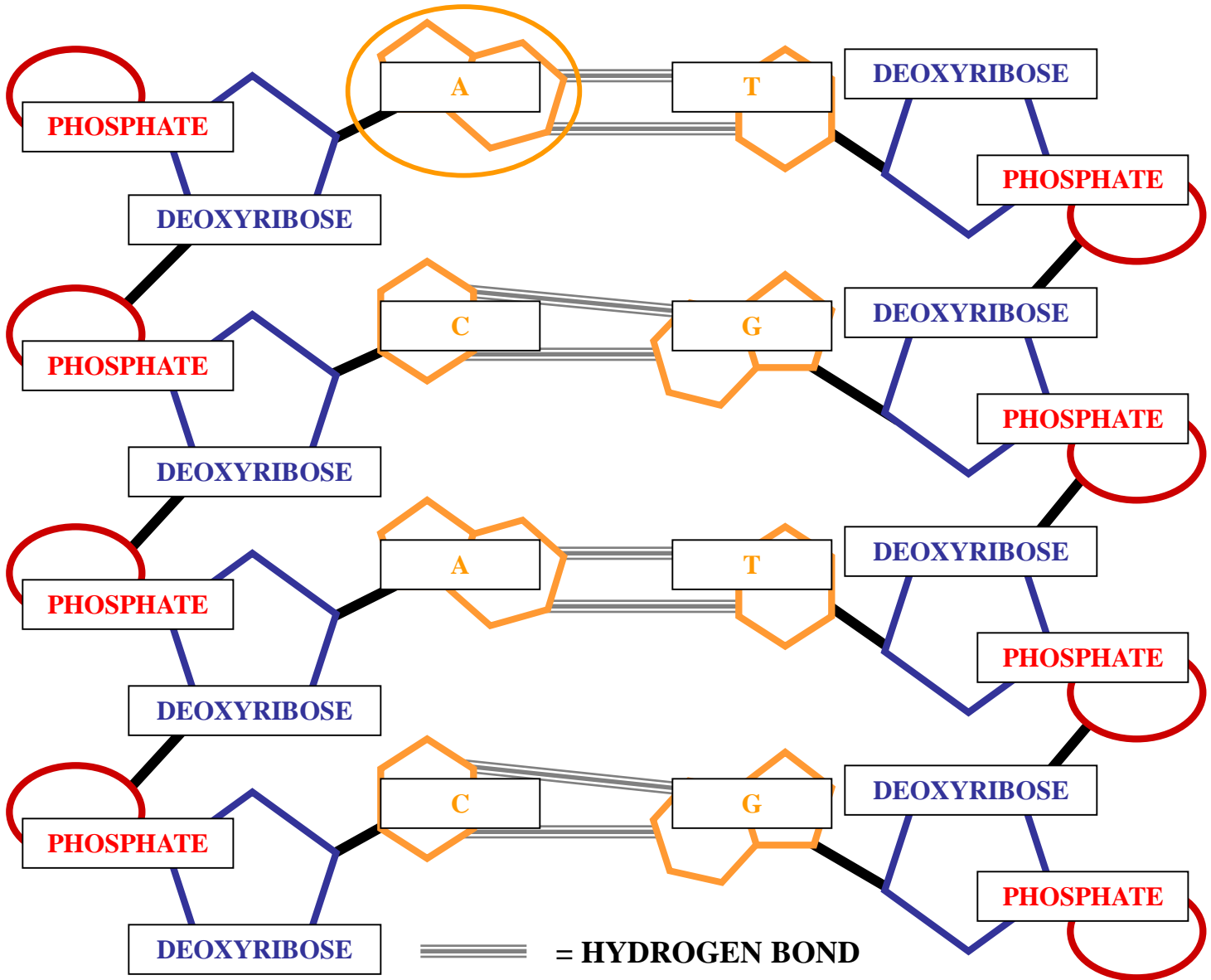

DNA DOUBLE HELIX MODEL

DNA REPLICATION

C

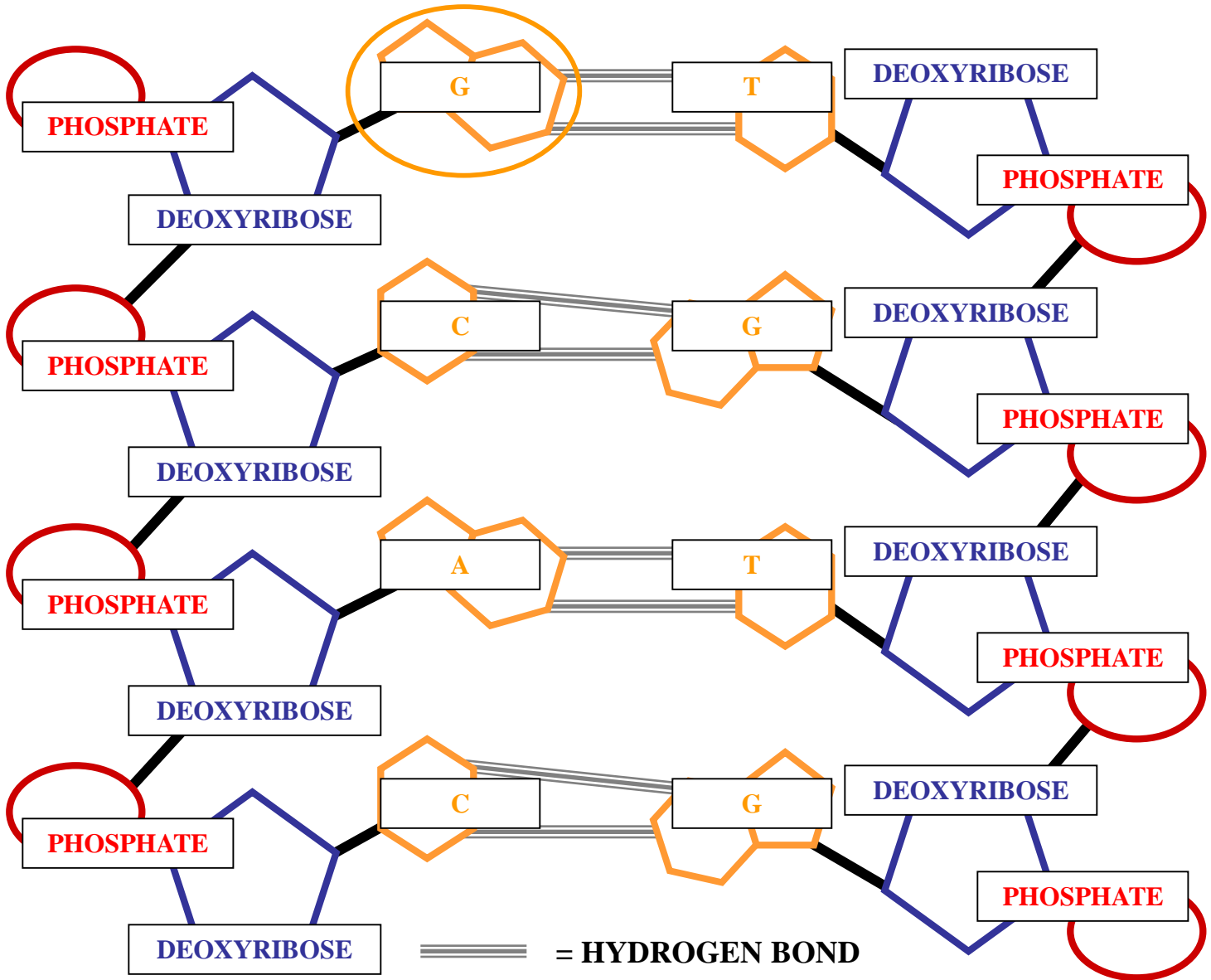
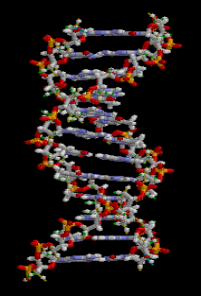

DNA DOUBLE HELIX MODEL

DNA REPLICATION DNA STRUCTURAL CHANGE

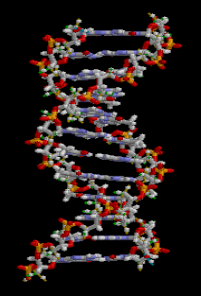

M

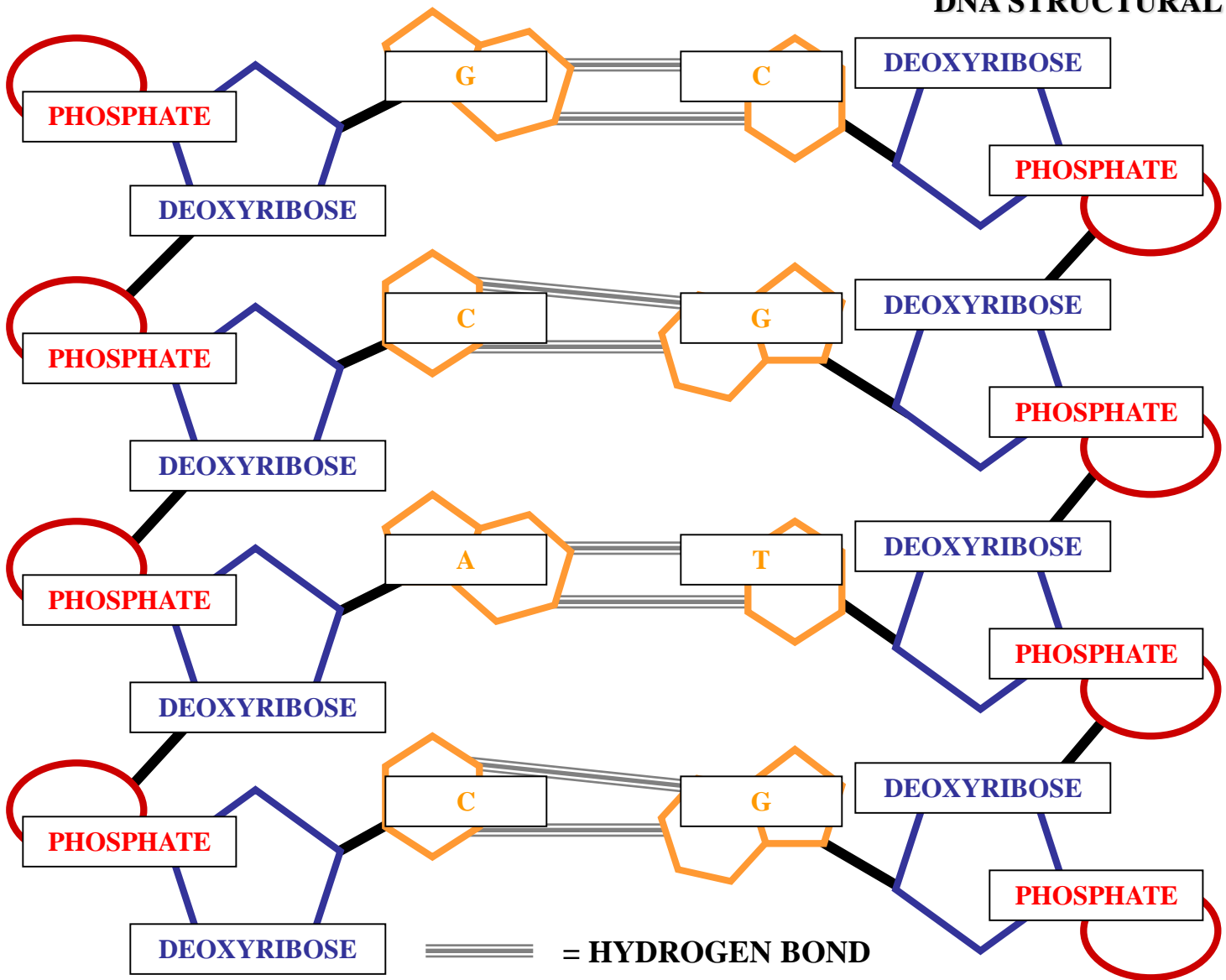



PROTEIN SYNTHESIS

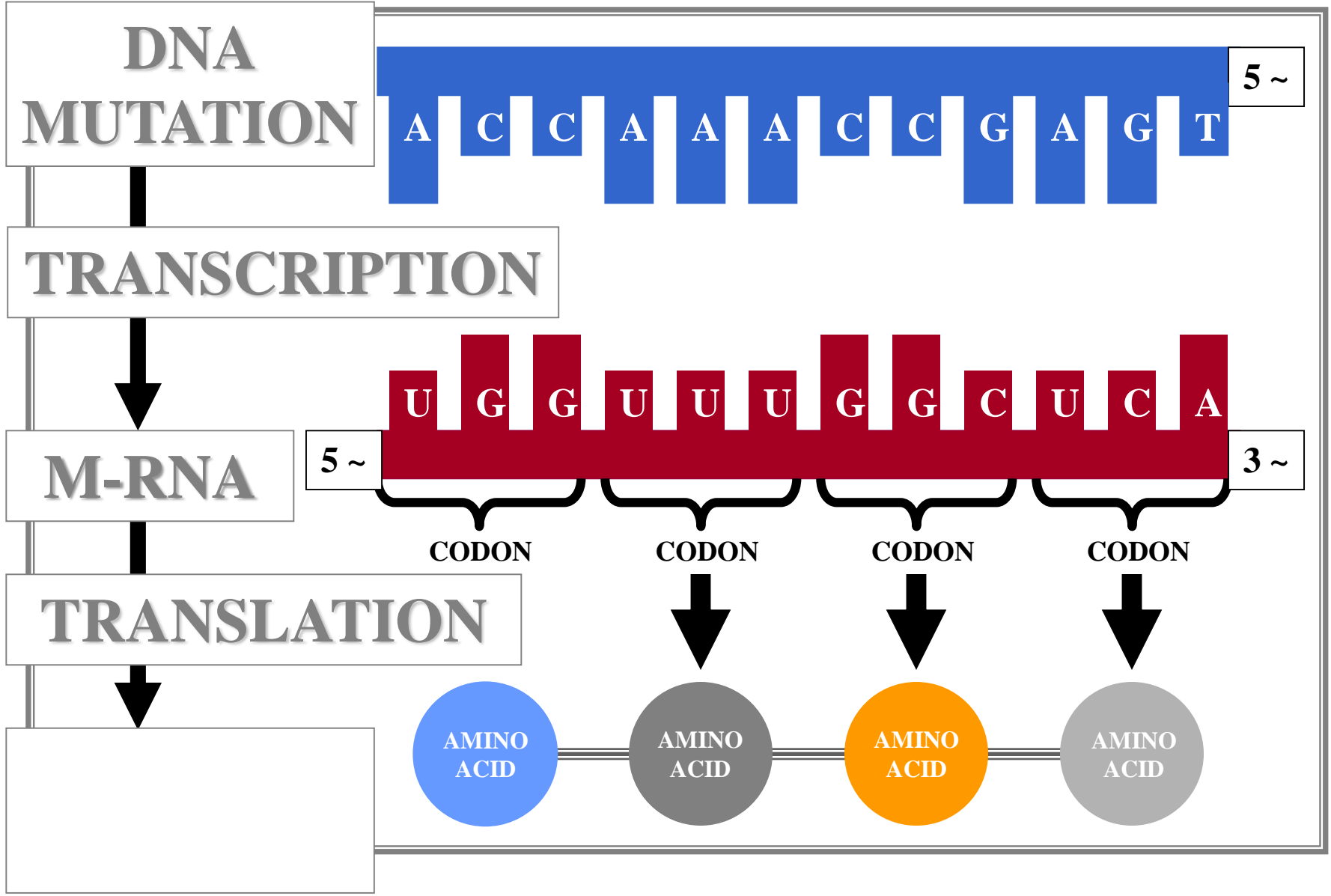



PROTEIN SYNTHESIS

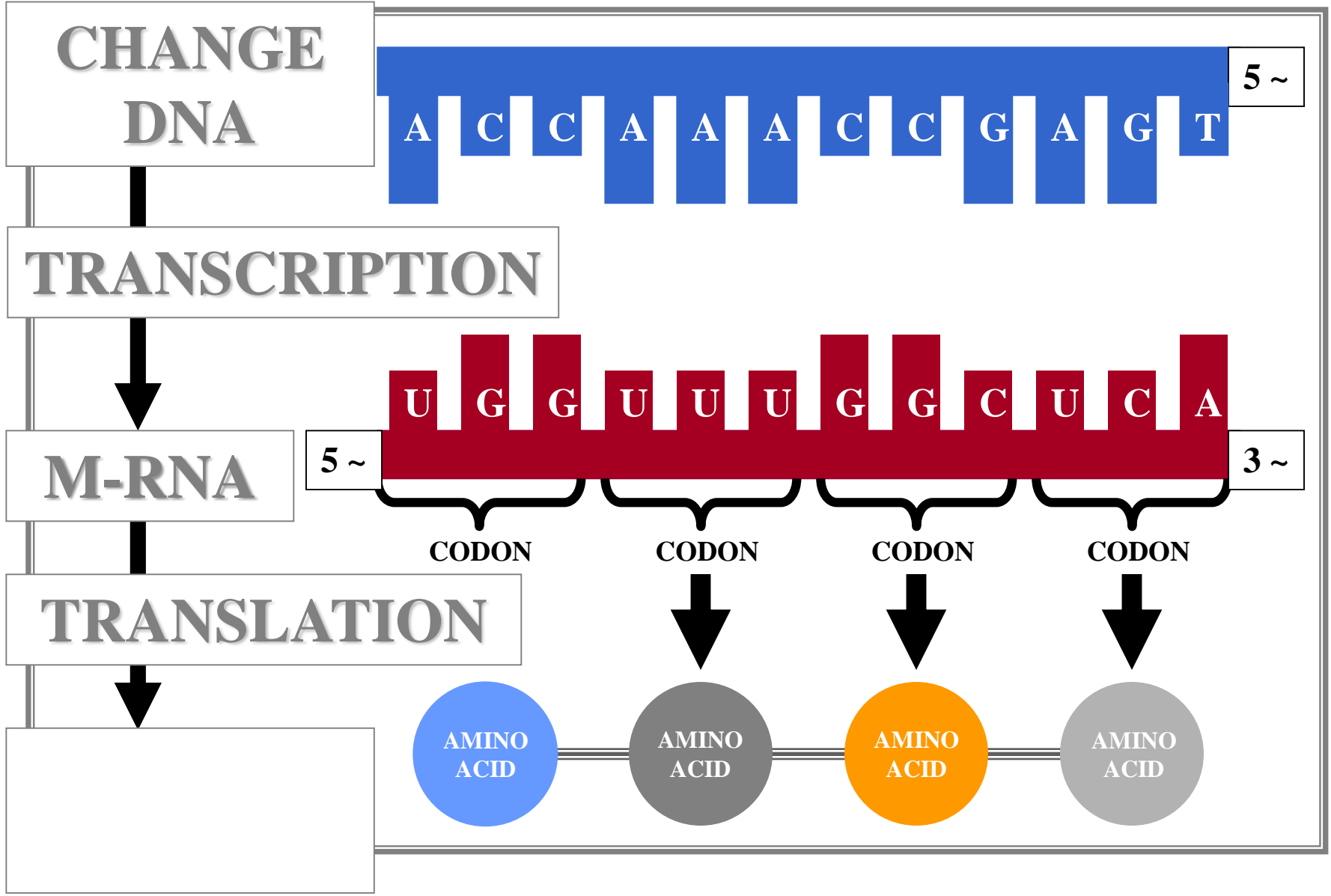



PROTEIN SYNTHESIS

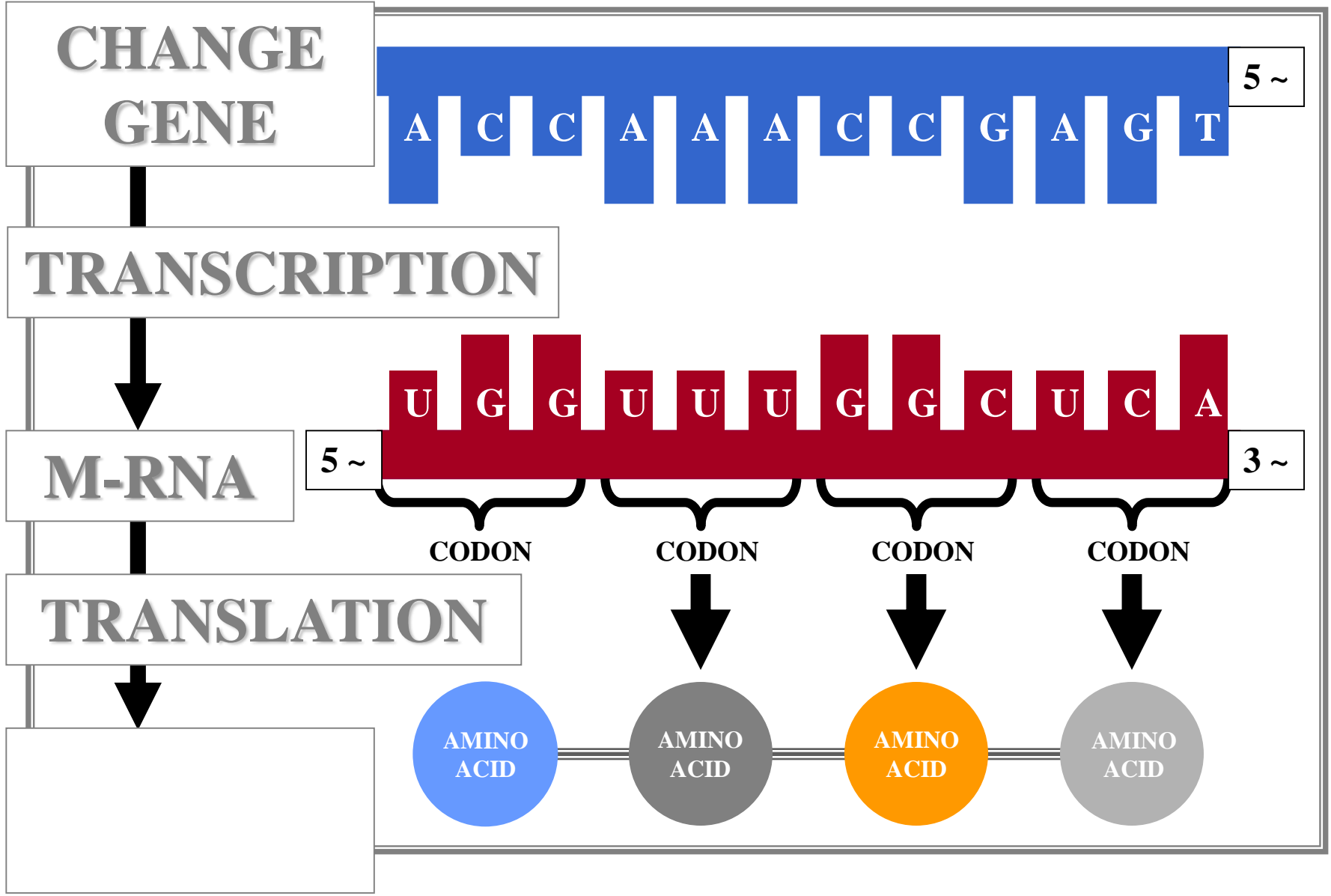



PROTEIN SYNTHESIS

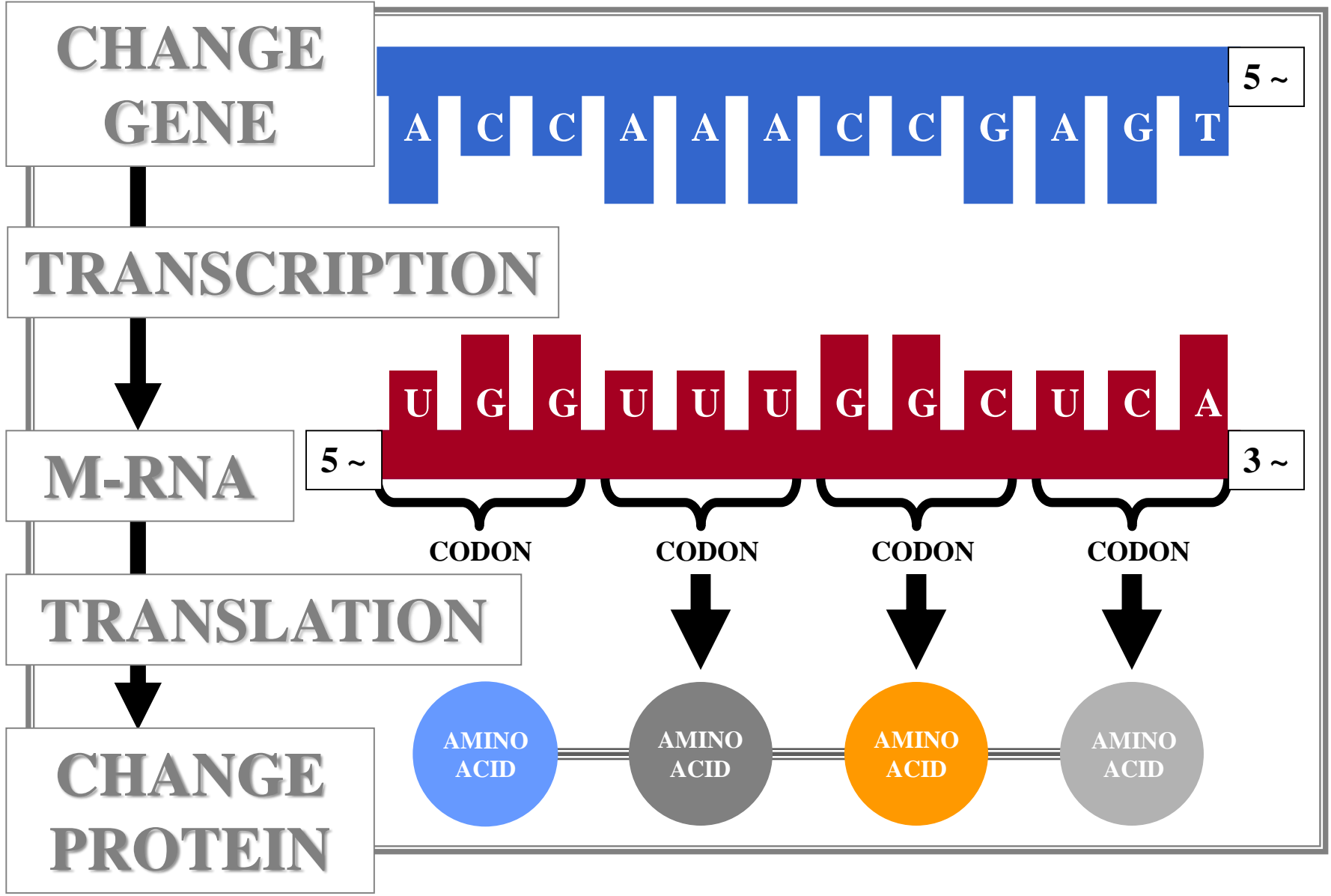



PROTEIN SYNTHESIS

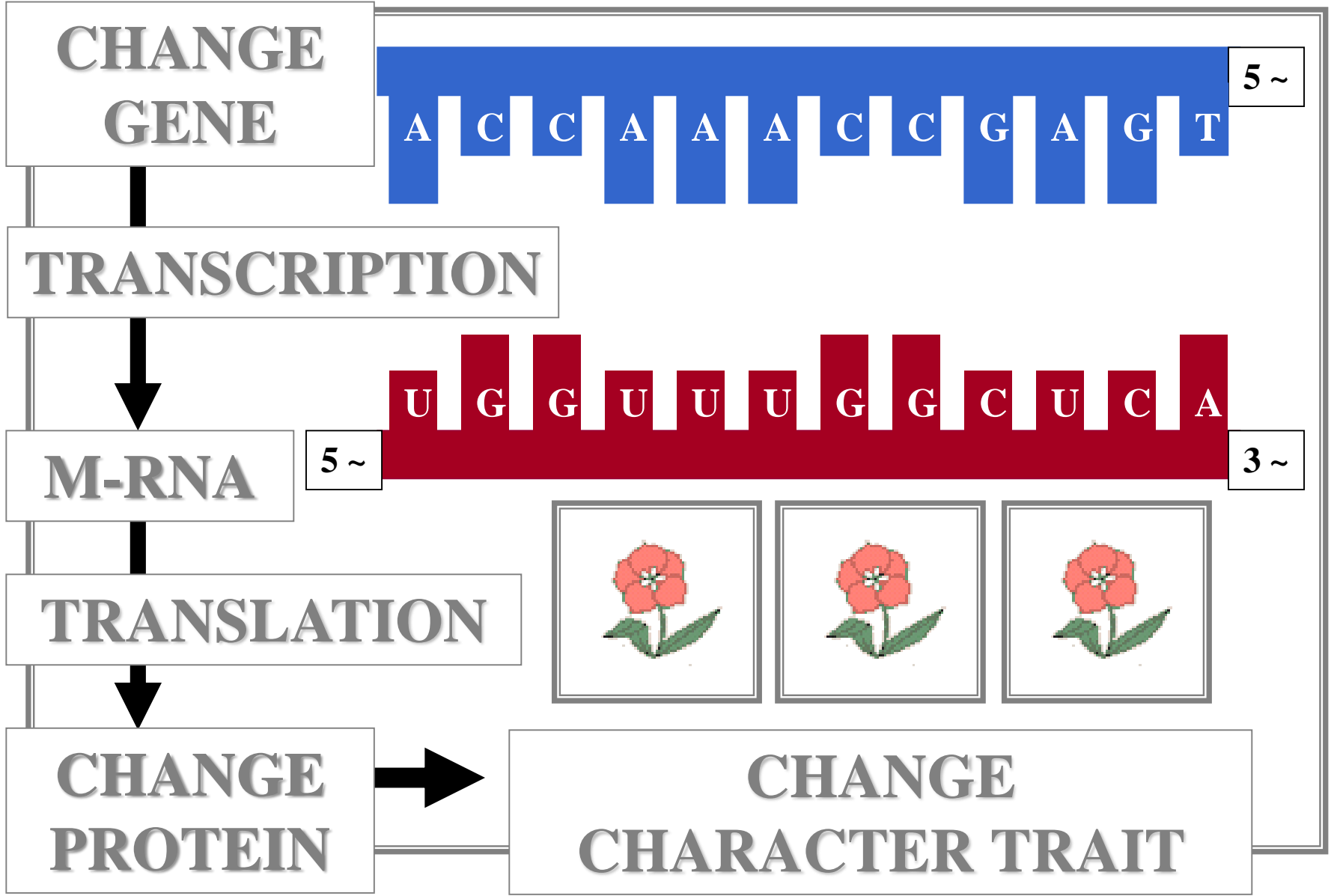



PROTEIN SYNTHESIS

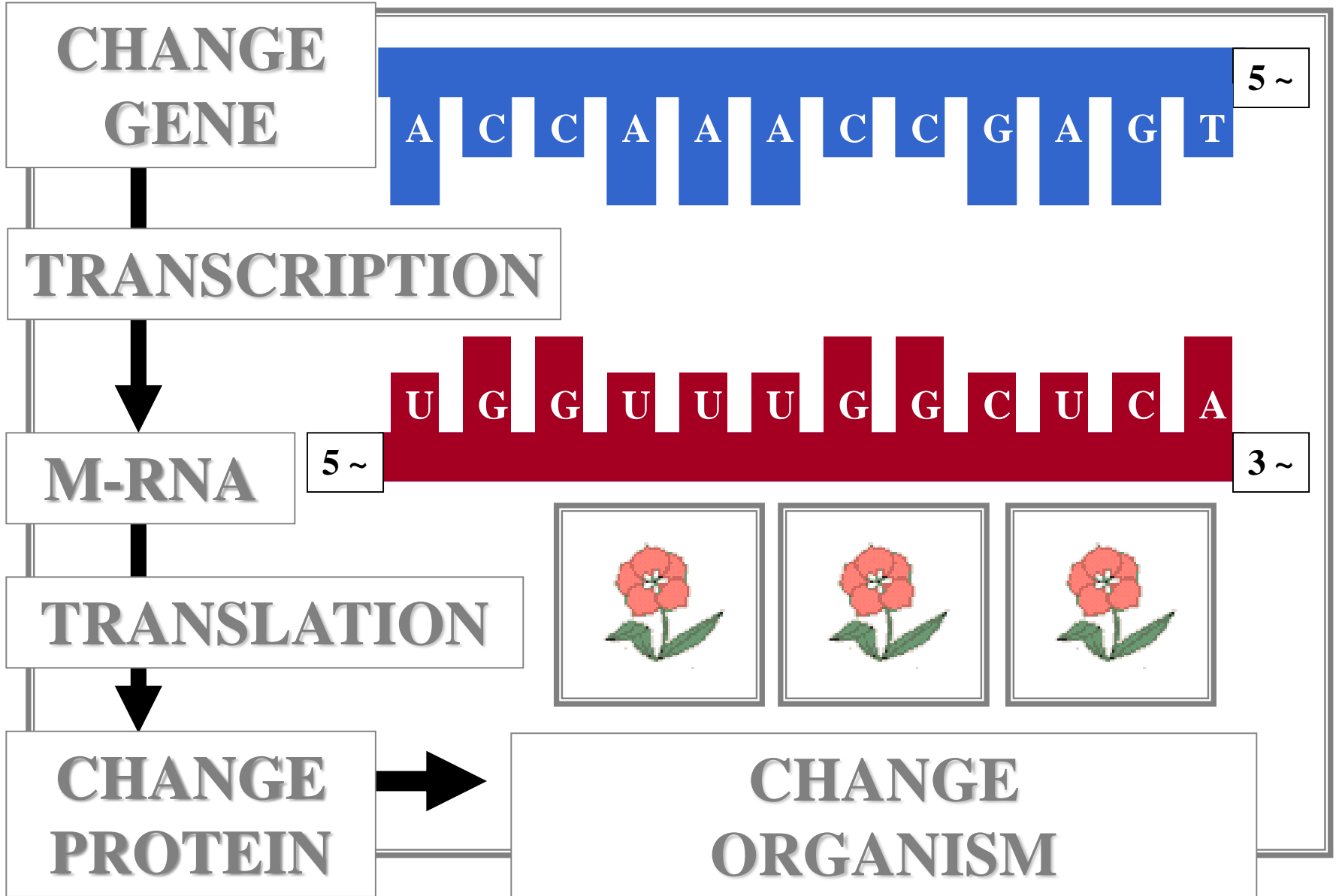

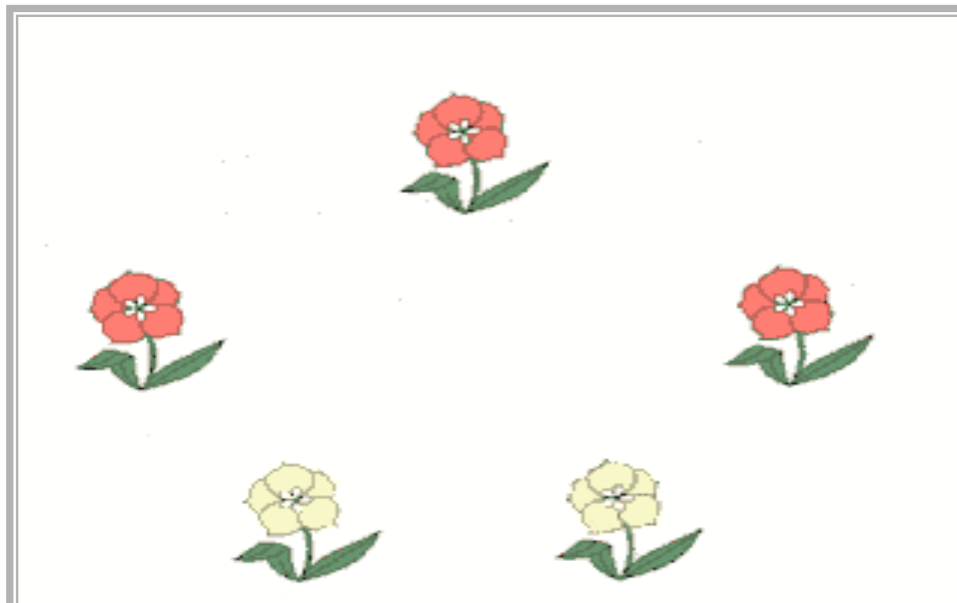

CHANGE ORGANISM

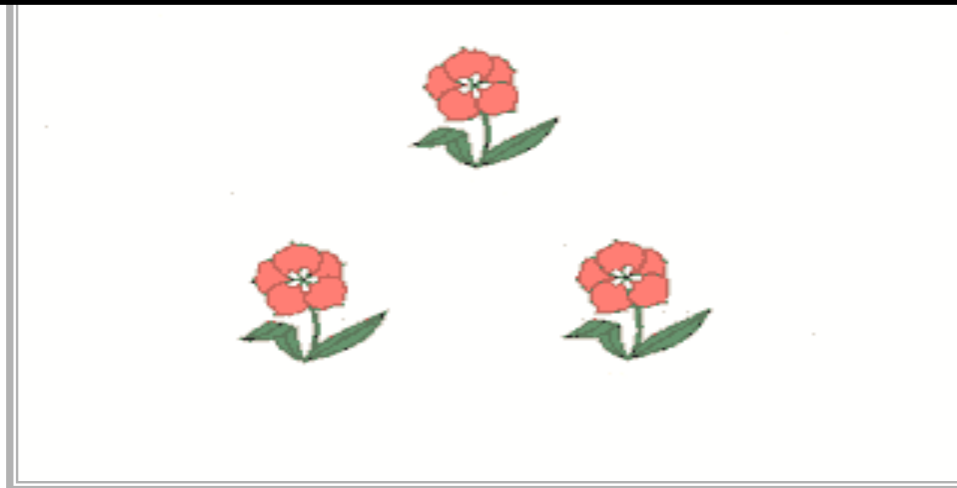

MUTATION: WHITE FLOWERED PLANTS

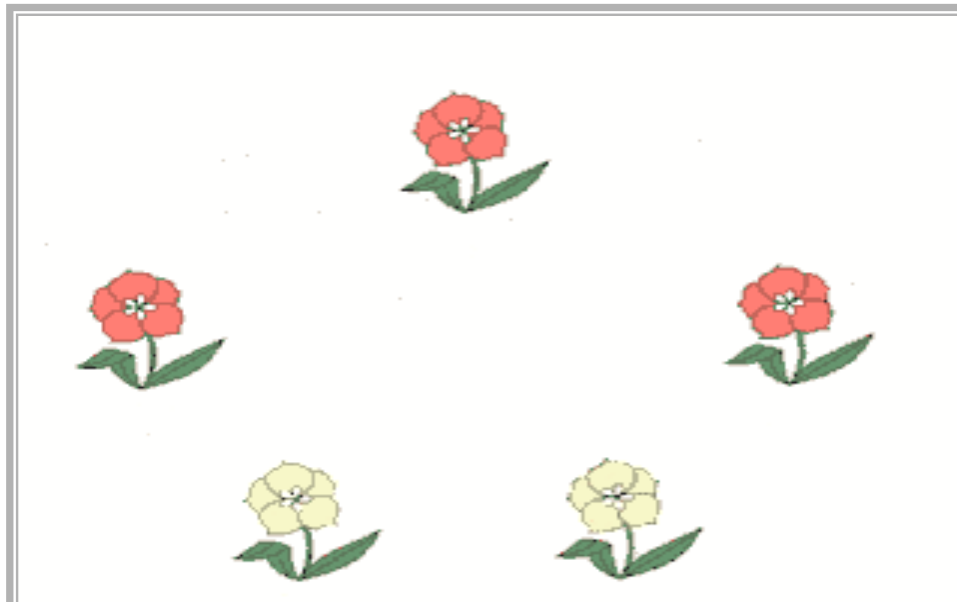

MUTATION UNDERGOES SURVIVAL TEST

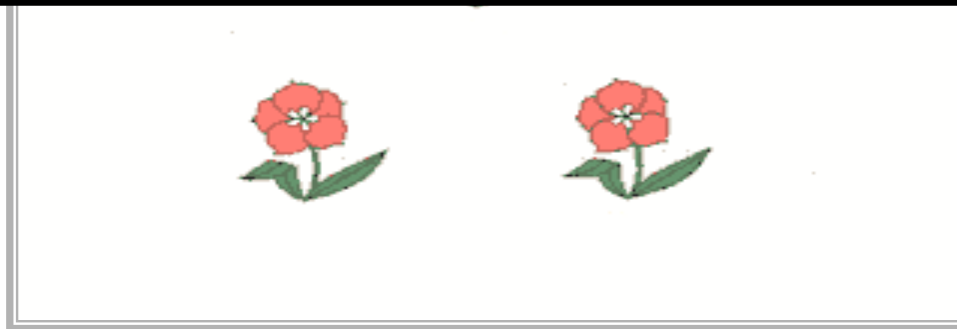

MUTATION: WHITE FLOWERED PLANTS

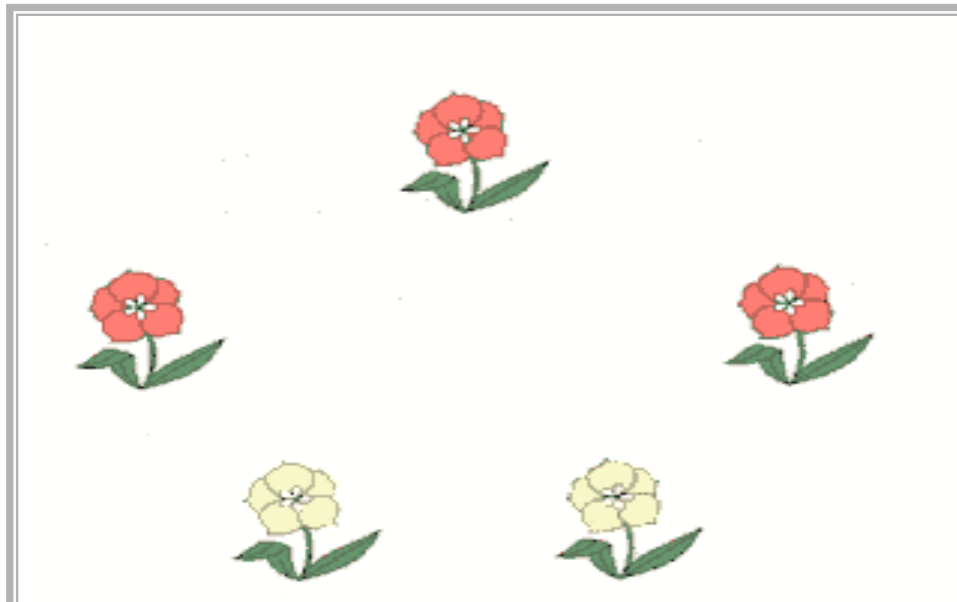

MUTATION UNDERGOES NATURAL SELECTION

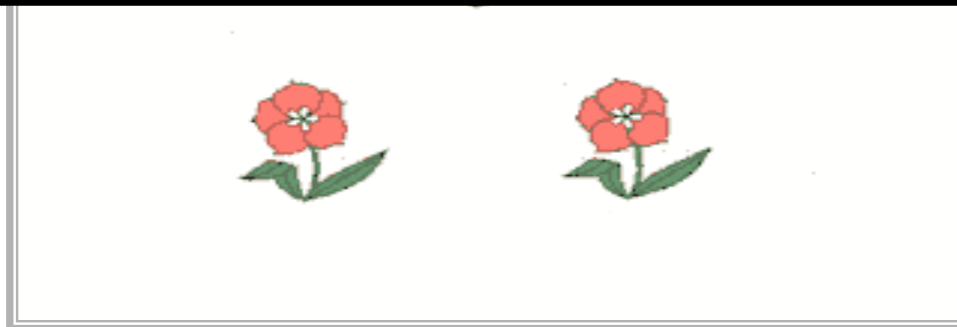

MUTATION: WHITE FLOWERED PLANTS

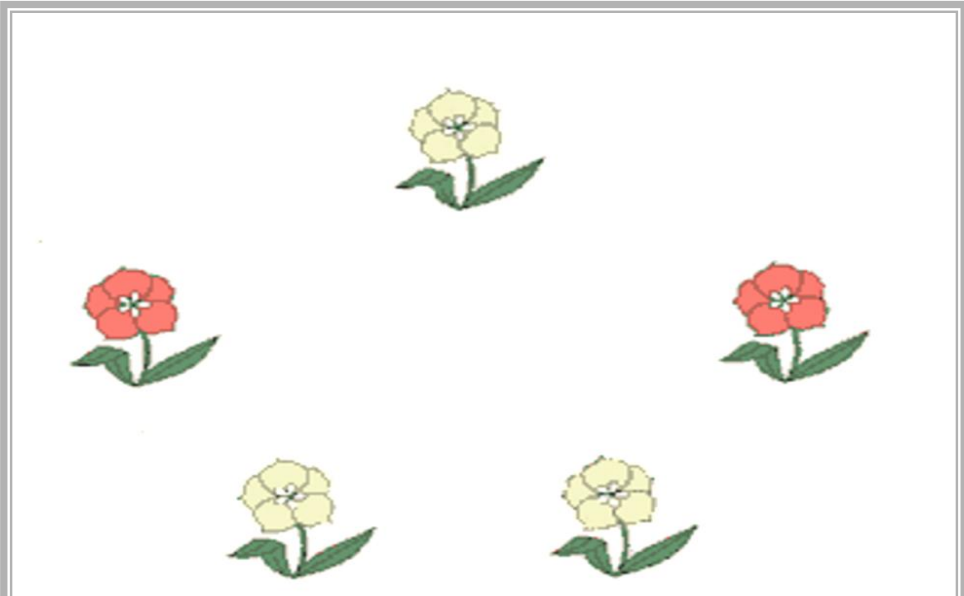

SPECIATION

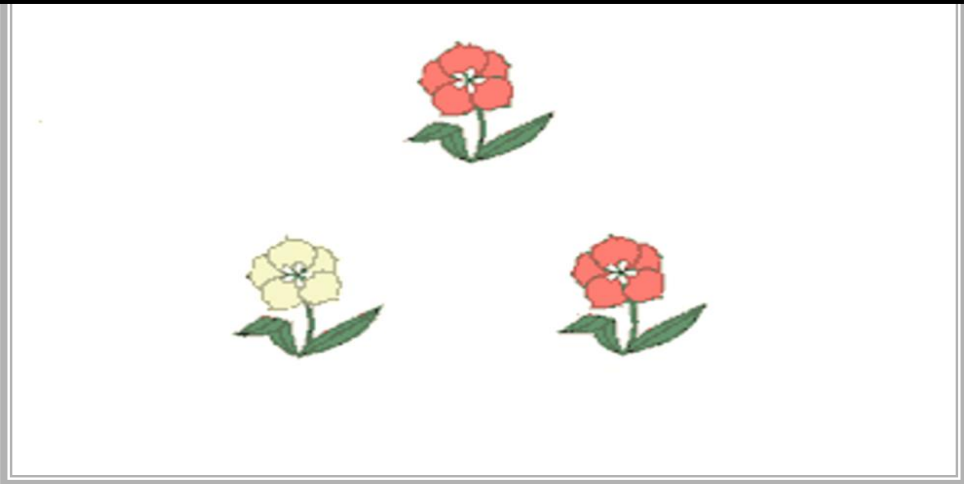

DAUGHTER SPECIES



N

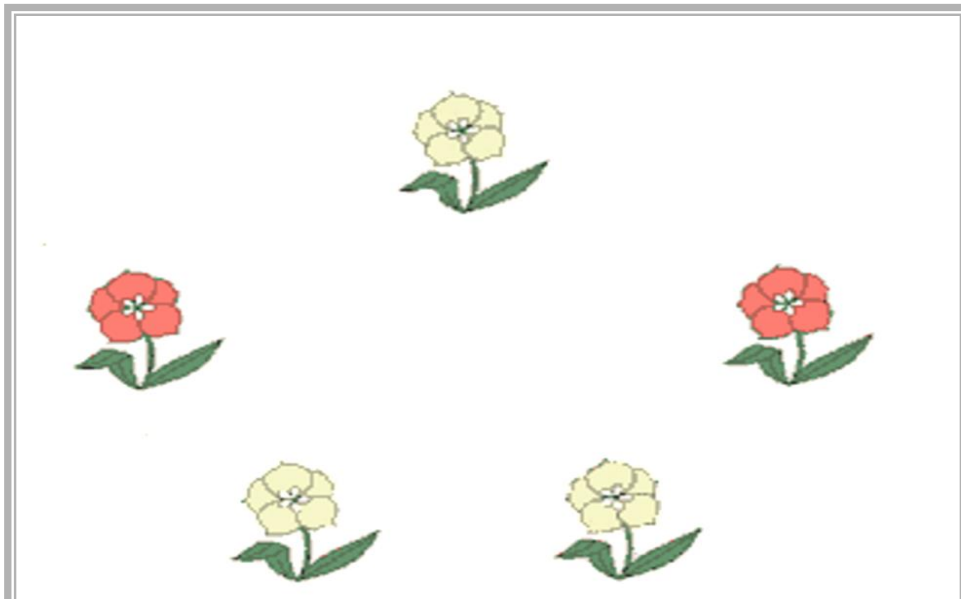

INCREASE BIO-DIVERSITY

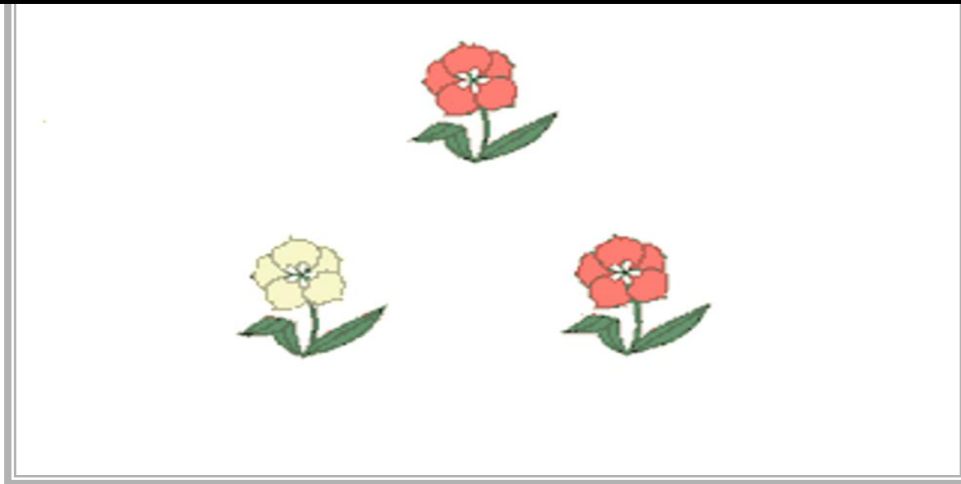

DAUGHTER SPECIES

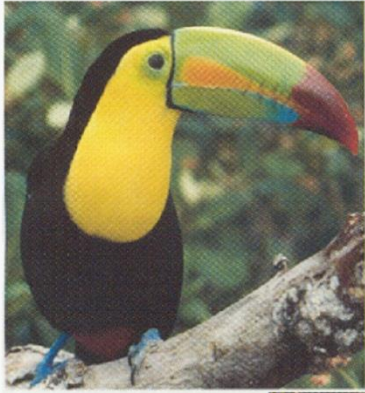

NATURAL SELECTION

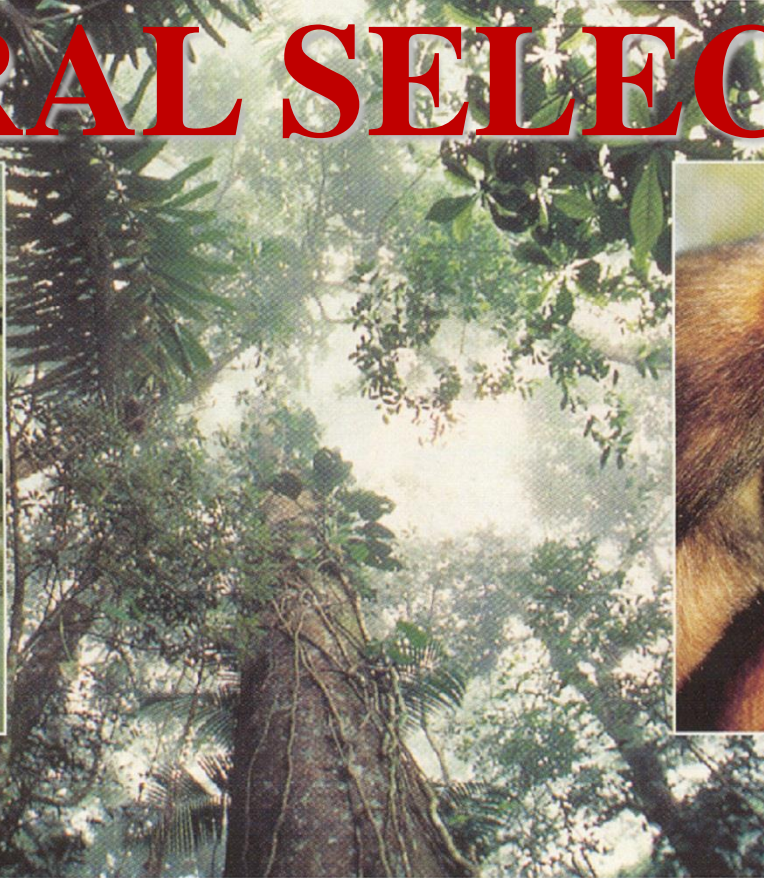
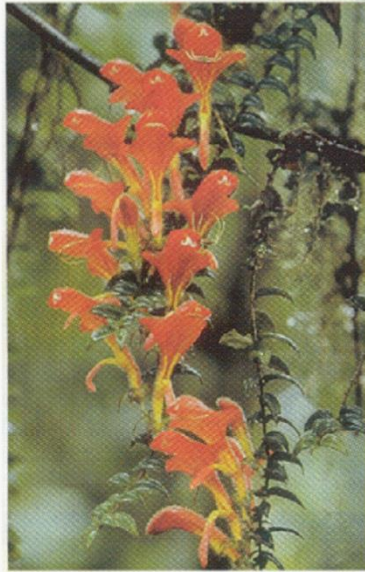

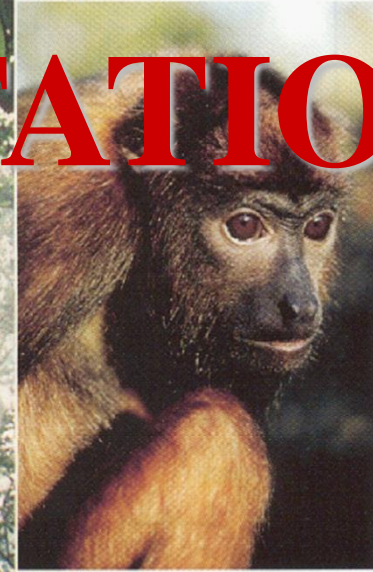
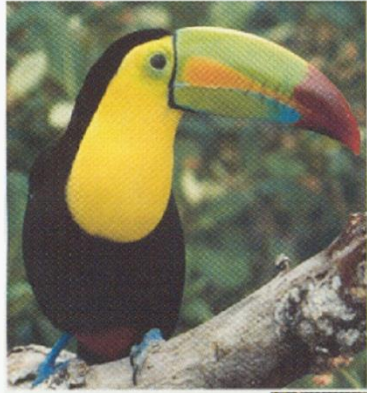

NATURAL SELECTION REQUIRES MUTATIONS

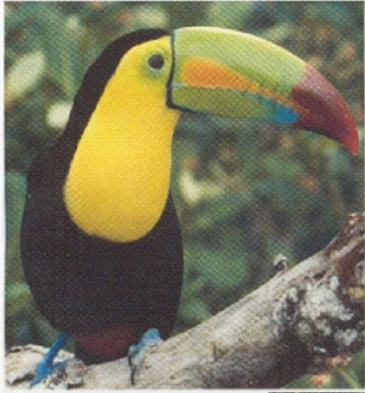

EVOLUTION

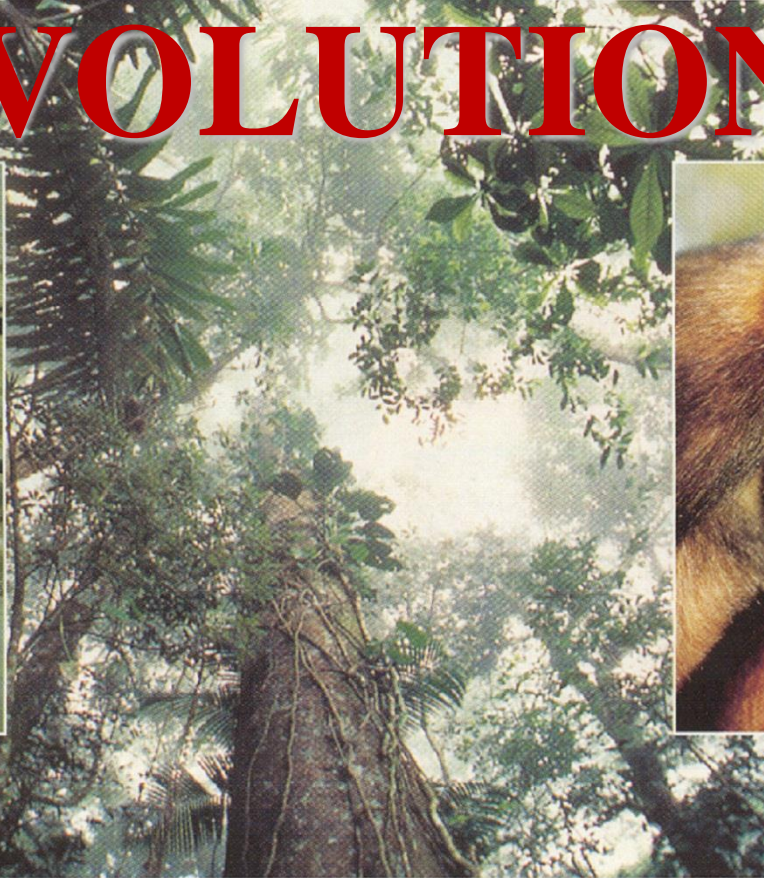
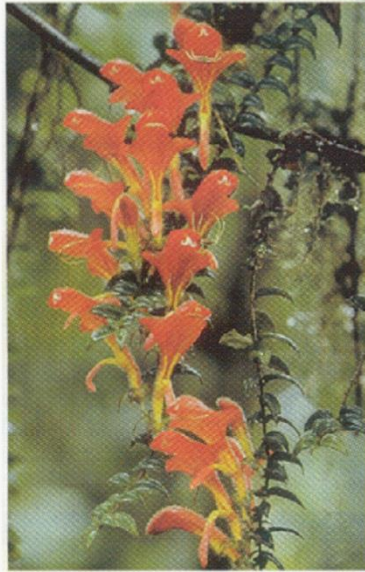

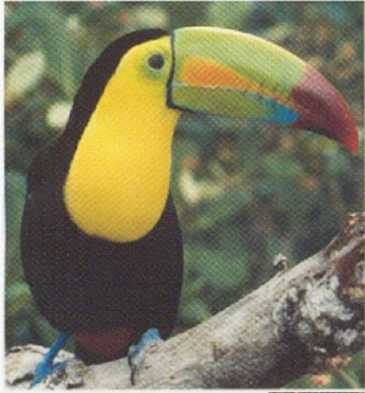

EVOLUTION

REQUIRES MUTATIONS

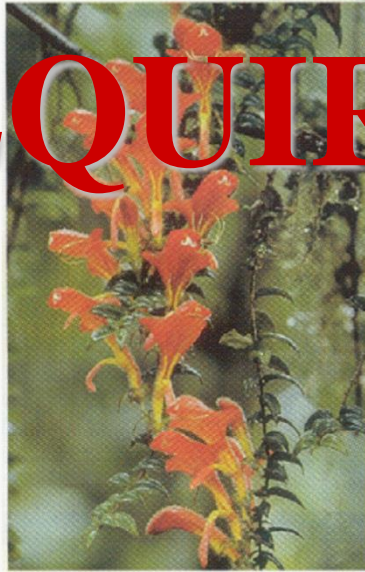



NATURAL SELECTION

SYNONYMOUS

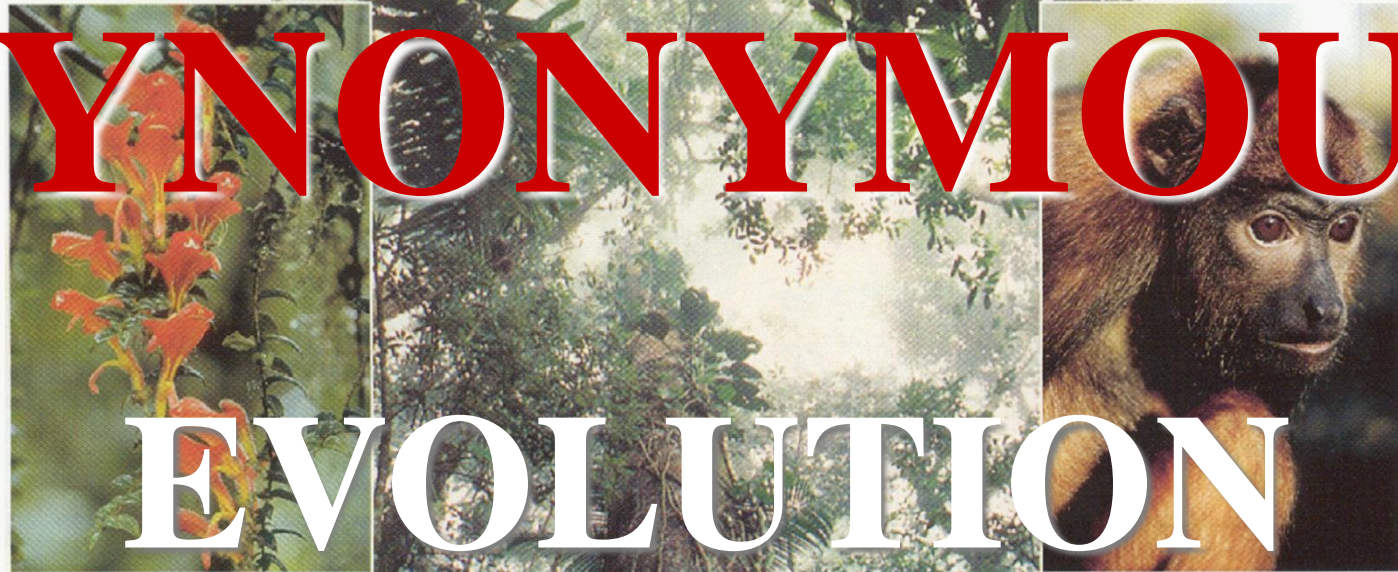

EVOLUTION

SUMMARY



EARTH

SUMMARY



EVOLUTION

EARTH

SUMMARY



EVOLUTION

MUTATIONS

EARTH

SUMMARY



EVOLUTION

NATURAL SELECTION

EARTH

SUMMARY

B

EVOLUTION

SPECIATION

EARTH

SUMMARY



EVOLUTION



BIO-DIVERSITY

EARTH



BIO-DIVERSITY

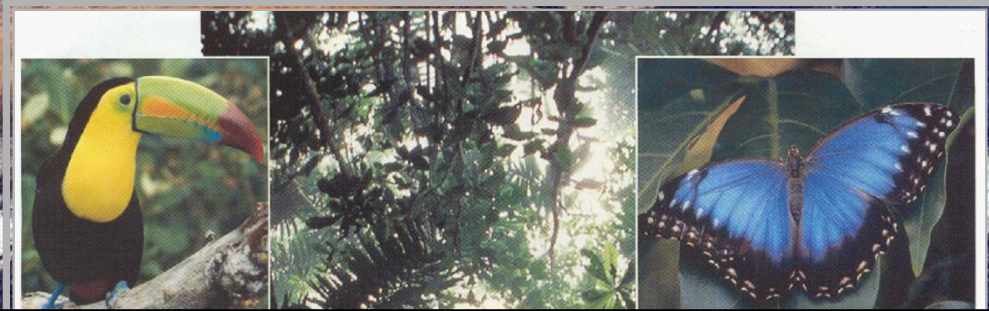

~10 MILLION SPECIES



EARTH

BIOLOGY DISCIPLINES

BIOLOGY DISCIPLINES

MICROBIOLOGY

BIOLOGY DISCIPLINES

BIOLOGY DISCIPLINES

MICROBIOLOGY

MYCOLOGY

BIOLOGY DISCIPLINES

BIOLOGY DISCIPLINES

MICROBIOLOGY

MYCOLOGY

ZOOLOGY

BIOLOGY DISCIPLINES

BIOLOGY DISCIPLINES

MICROBIOLOGY

MYCOLOGY

ZOOLOGY

BOTANY

BIOLOGY DISCIPLINES

MICROBIOLOGY

MICROBIOLOGY



STUDY

BACTERIA AND VIRUSES

MICROBIOLOGY